



US00D471637S

(12) **United States Design Patent**  
**Schild**

(10) **Patent No.:** **US D471,637 S**

(45) **Date of Patent:** **\*\* Mar. 11, 2003**

(54) **INFLATABLE FOOT EXERCISER**

(75) Inventor: **Rolf Schild**, London (GB)

(73) Assignee: **Huntleigh Technology PLC** (GB)

(\*\*) Term: **14 Years**

(21) Appl. No.: **29/154,219**

(22) Filed: **Jan. 18, 2002**

(30) **Foreign Application Priority Data**

Jul. 20, 2001 (GB) ..... 2103335

(51) **LOC (7) Cl.** ..... **28-03**

(52) **U.S. Cl.** ..... **D24/213**

(58) **Field of Search** ..... D24/213, 212,  
D24/200; 601/27, 29, 30, 23; 482/79, 80,  
122, 123; 272/70

(56) **References Cited**

**U.S. PATENT DOCUMENTS**

4,516,768 A *	5/1985	Gallaro	482/26
D329,499 S *	9/1992	Ohashi	D24/213
5,645,516 A *	7/1997	Foster	482/79
5,813,958 A *	9/1998	Tomita	482/146
6,217,488 B1 *	4/2001	Bernardson	482/79
D444,884 S *	7/2001	Huang	D24/213

\* cited by examiner

*Primary Examiner*—Stella Reid

(74) *Attorney, Agent, or Firm*—Brown Raysman Millstein  
Felder & Steiner LLP

(57) **CLAIM**

I claim the ornamental design for an inflatable foot exerciser, as shown and described.

**DESCRIPTION**

FIG. 1 is a perspective view of an embodiment of an inflated inflatable foot exerciser according to my new design;

FIG. 2 is a top view thereof;

FIG. 3 is a bottom view thereof;

FIG. 4 is a front view thereof;

FIG. 5 is a back side view thereof;

FIG. 6 is a left side view thereof;

FIG. 7 is a right side view thereof;

FIG. 8 is a perspective view of another embodiment of an inflated inflatable foot exerciser according to my new design;

FIG. 9 is a perspective view of the inflatable foot exerciser of FIGS. 1–7 in an uninflated condition;

FIG. 10 is a top view thereof;

FIG. 11 is a bottom view thereof;

FIG. 12 is a front view thereof;

FIG. 13 is a back side view thereof;

FIG. 14 is a left side view thereof;

FIG. 15 is a right side view thereof; and,

FIG. 16 is a perspective view of the inflatable foot exerciser of FIG. 8 in an uninflated condition.

FIGS. 8 and 16 present perspective views of another embodiment of the inflatable foot exerciser according to my new design. Surfaces of the embodiment not shown in FIGS. 8 and 16 are the same as those shown for the first embodiment.

**1 Claim, 12 Drawing Sheets**

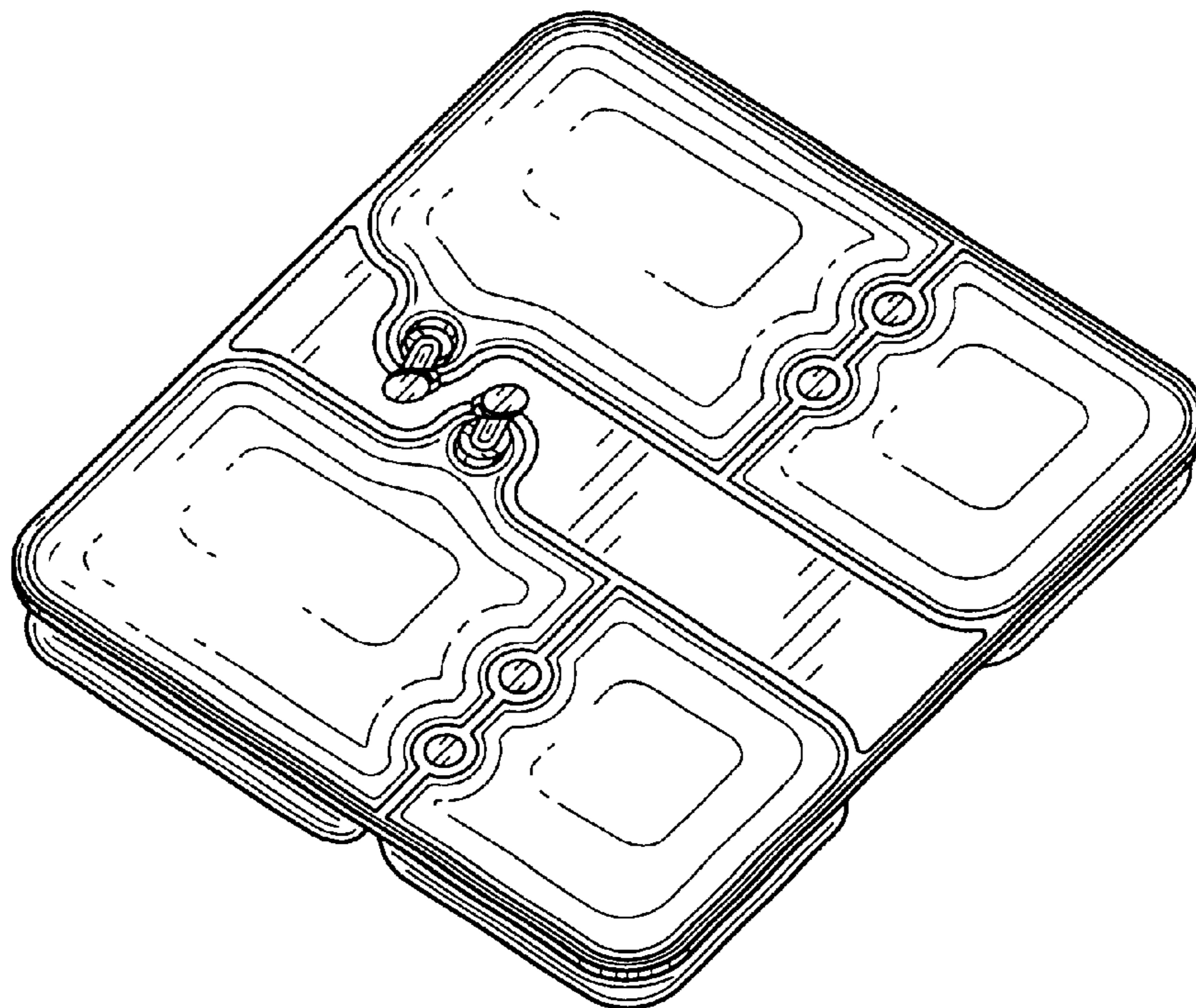

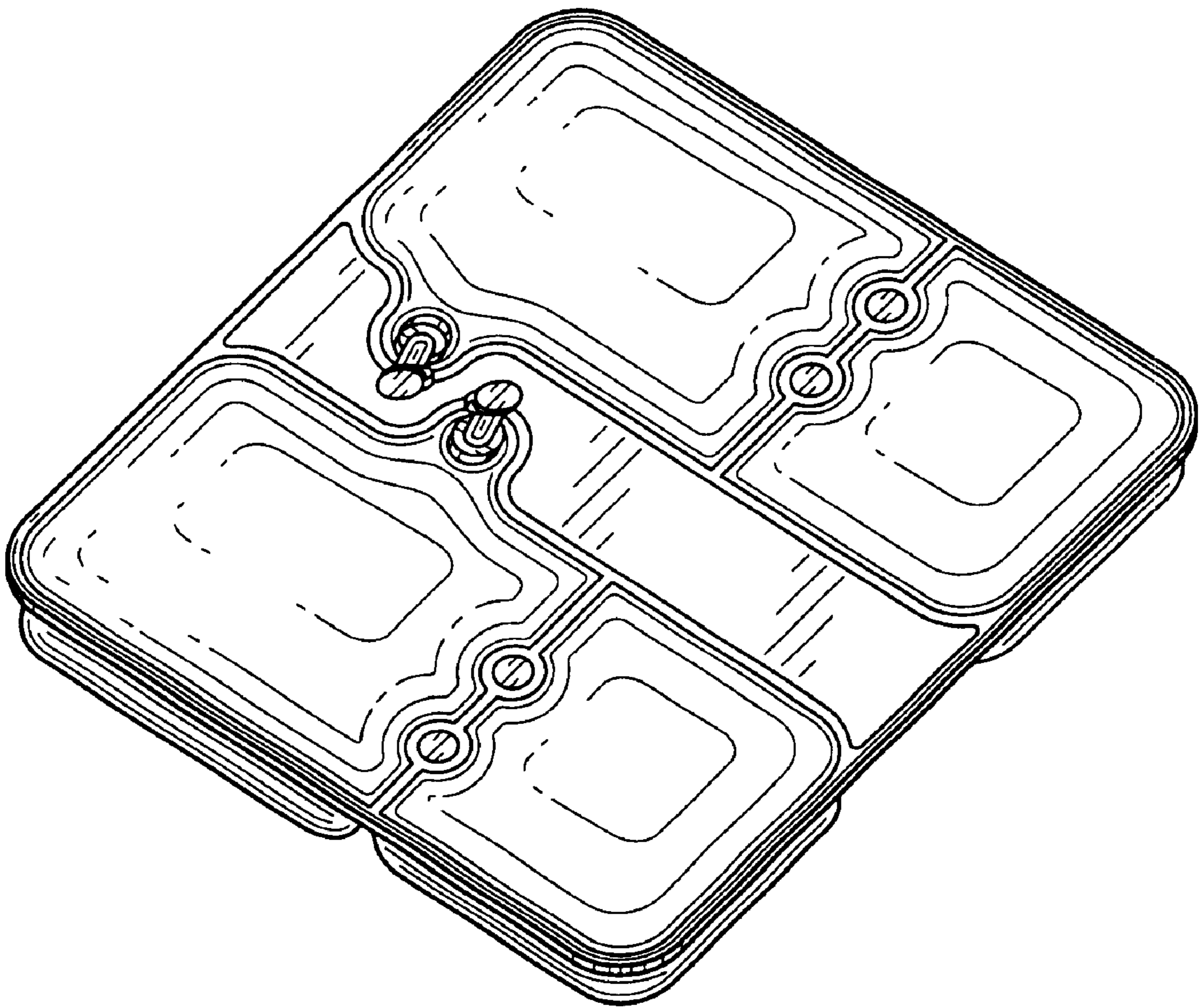

FIG. 1

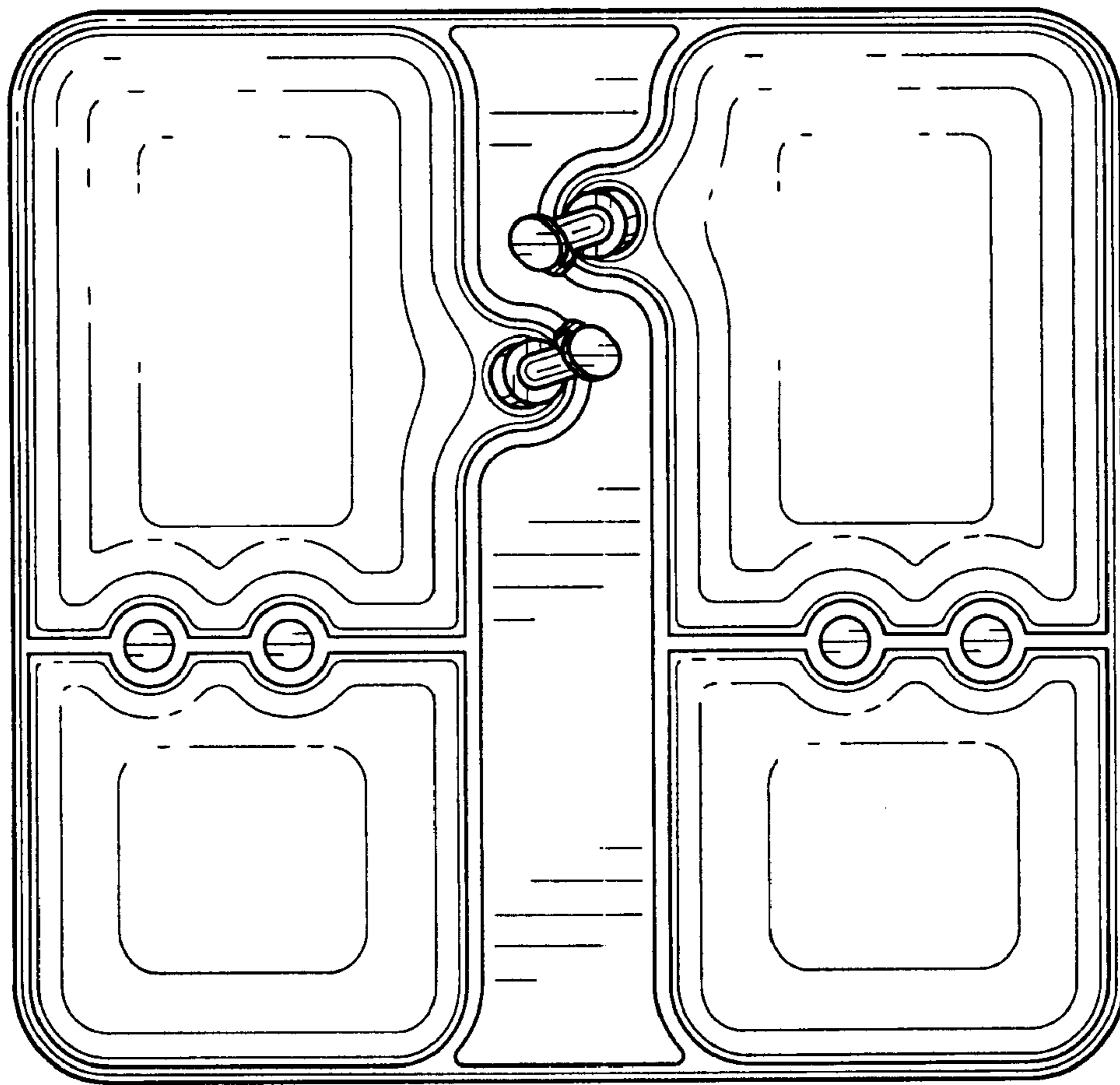

FIG. 2

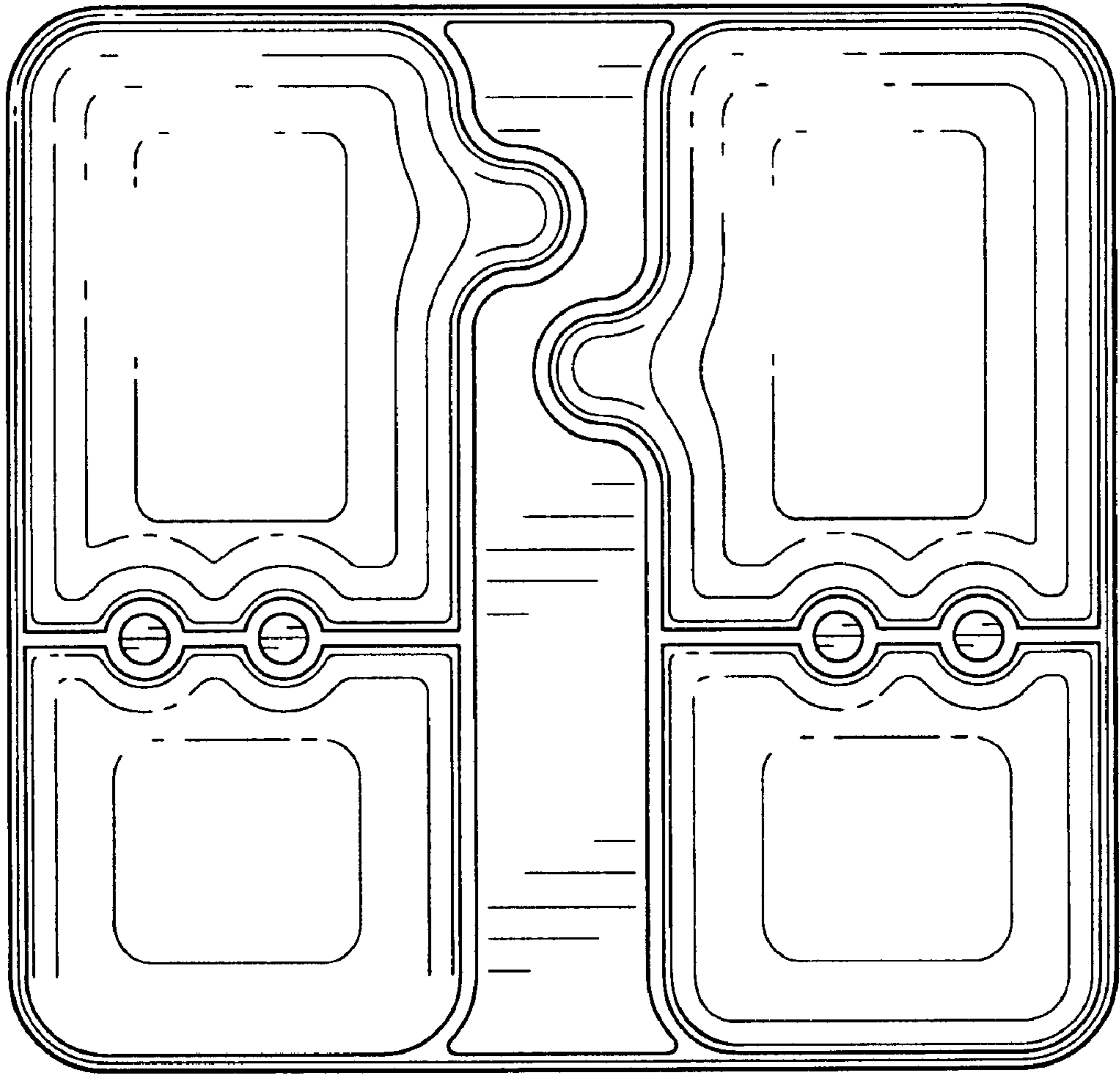

FIG. 3

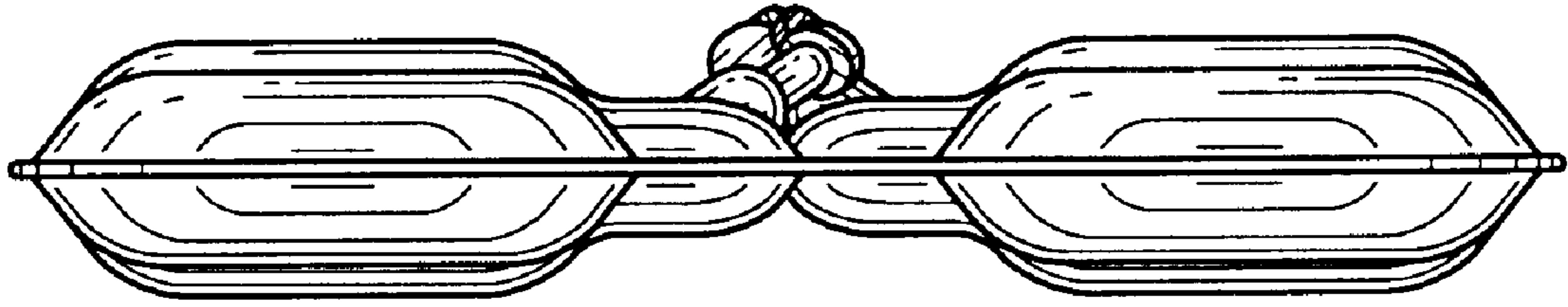

FIG. 4

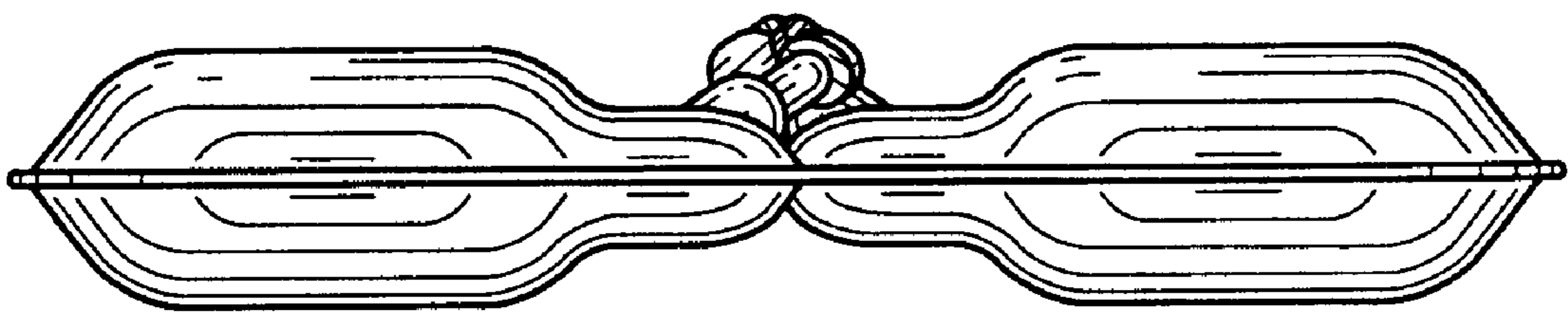

FIG. 5

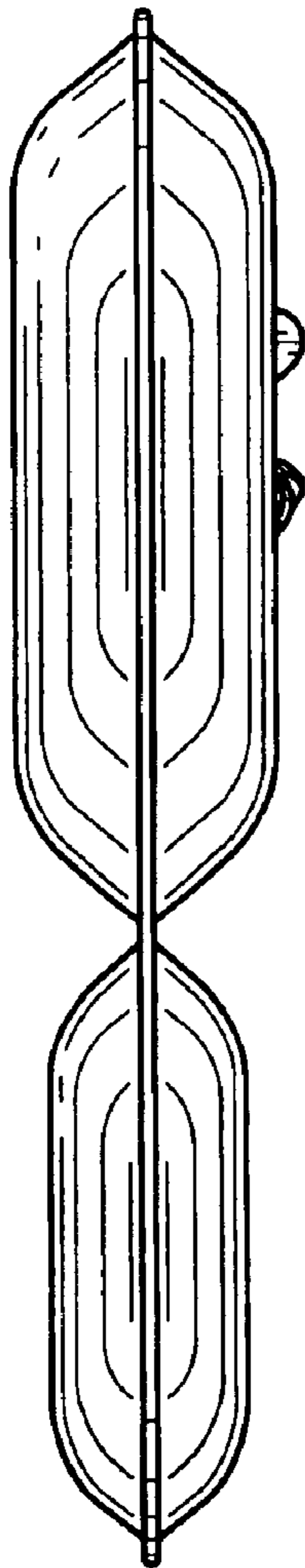

FIG. 6

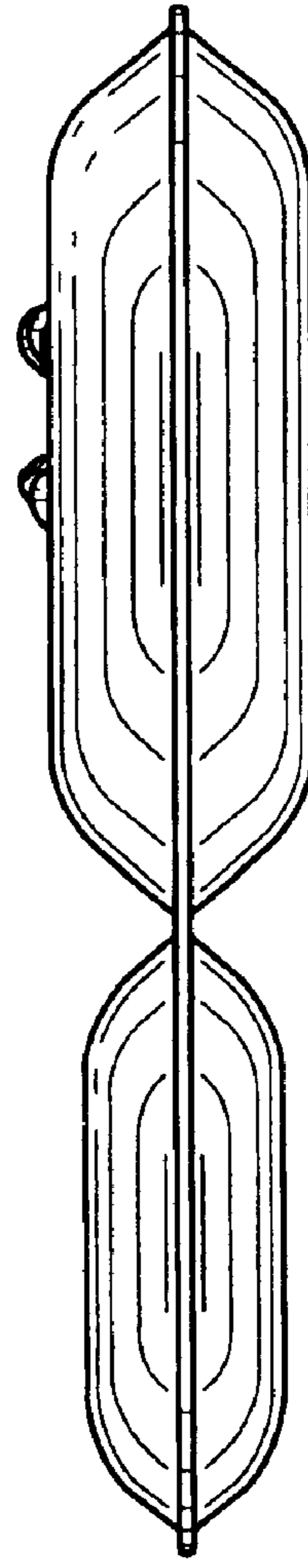

FIG. 7

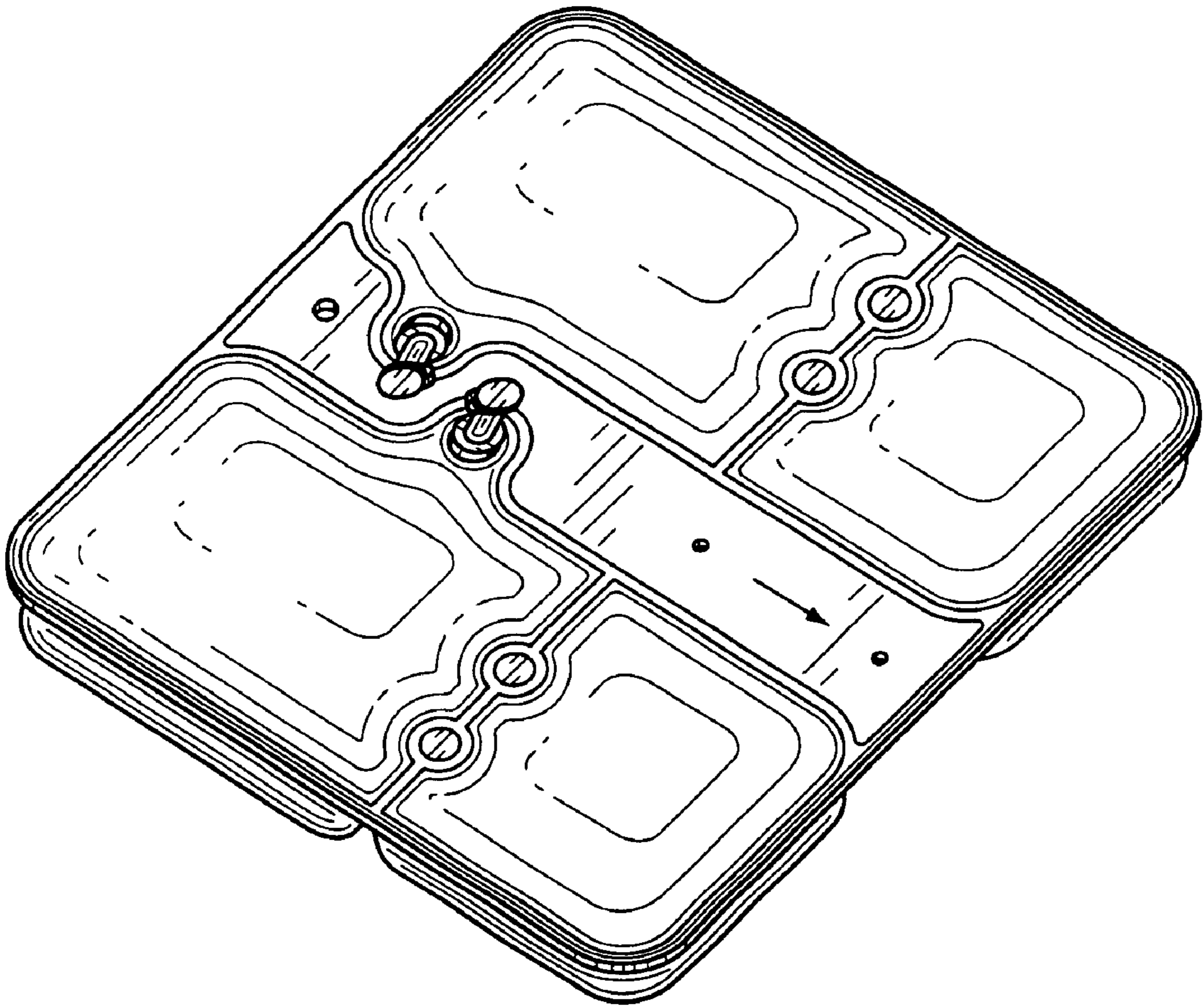

FIG. 8

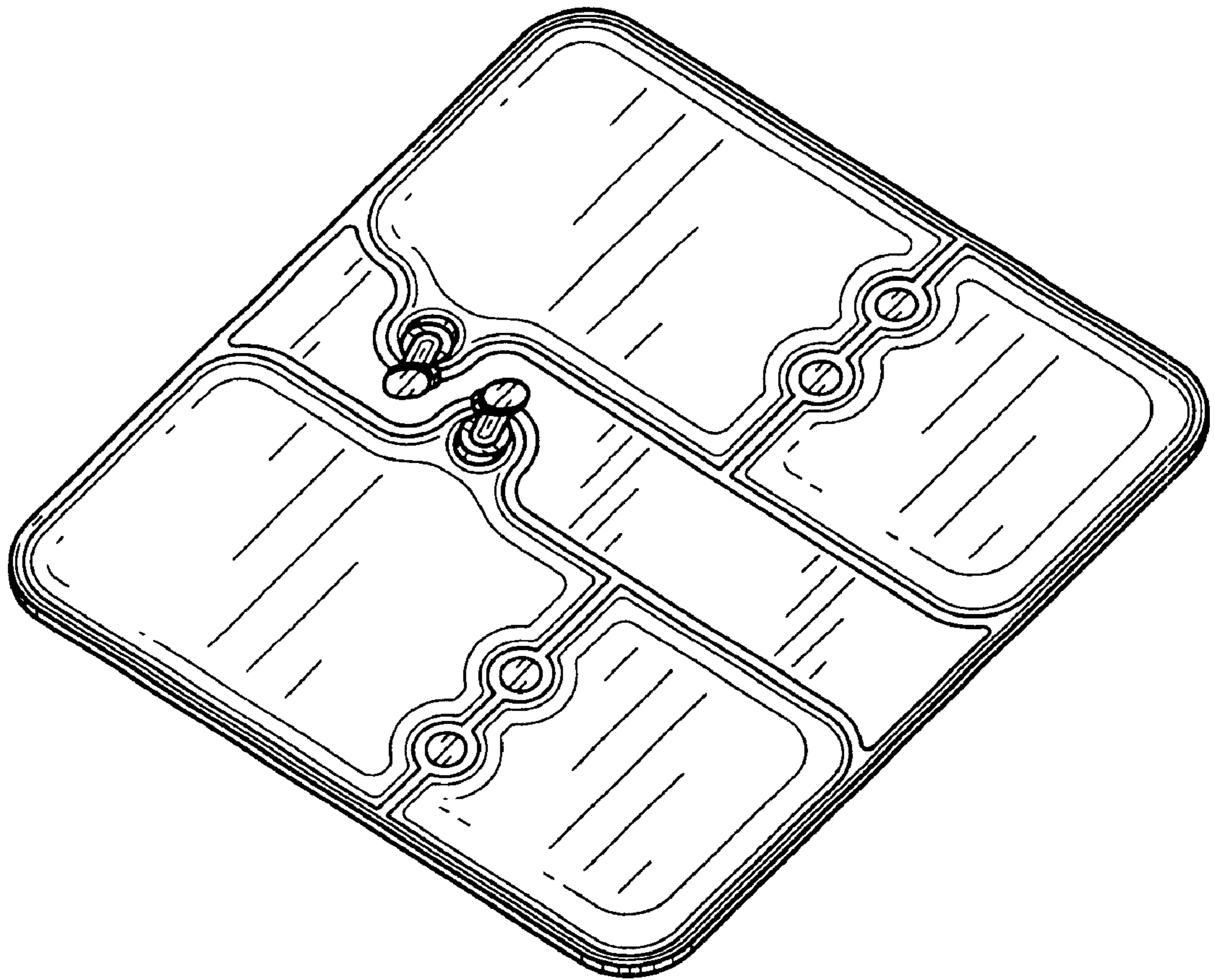

FIG. 9



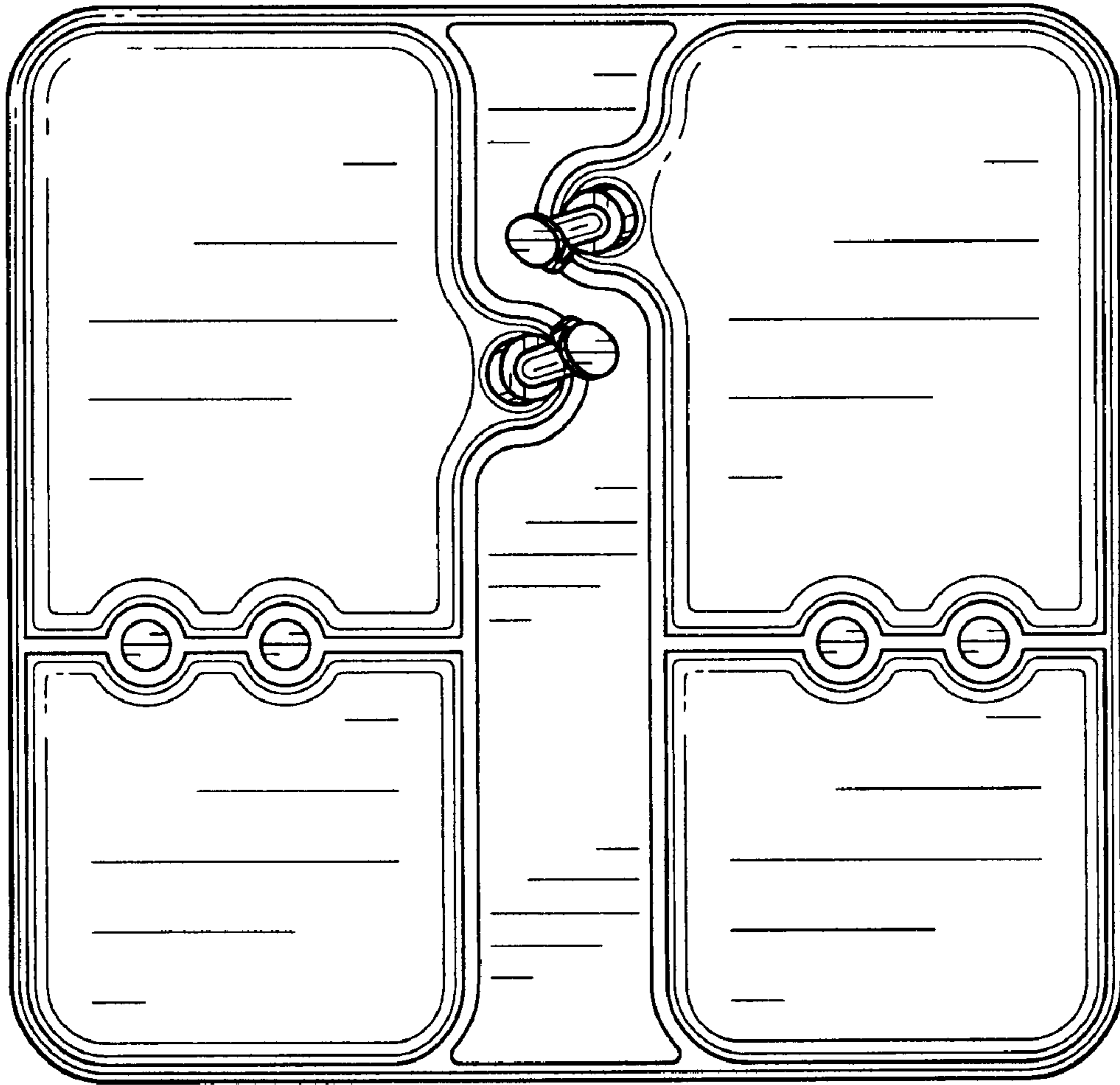

FIG. 10

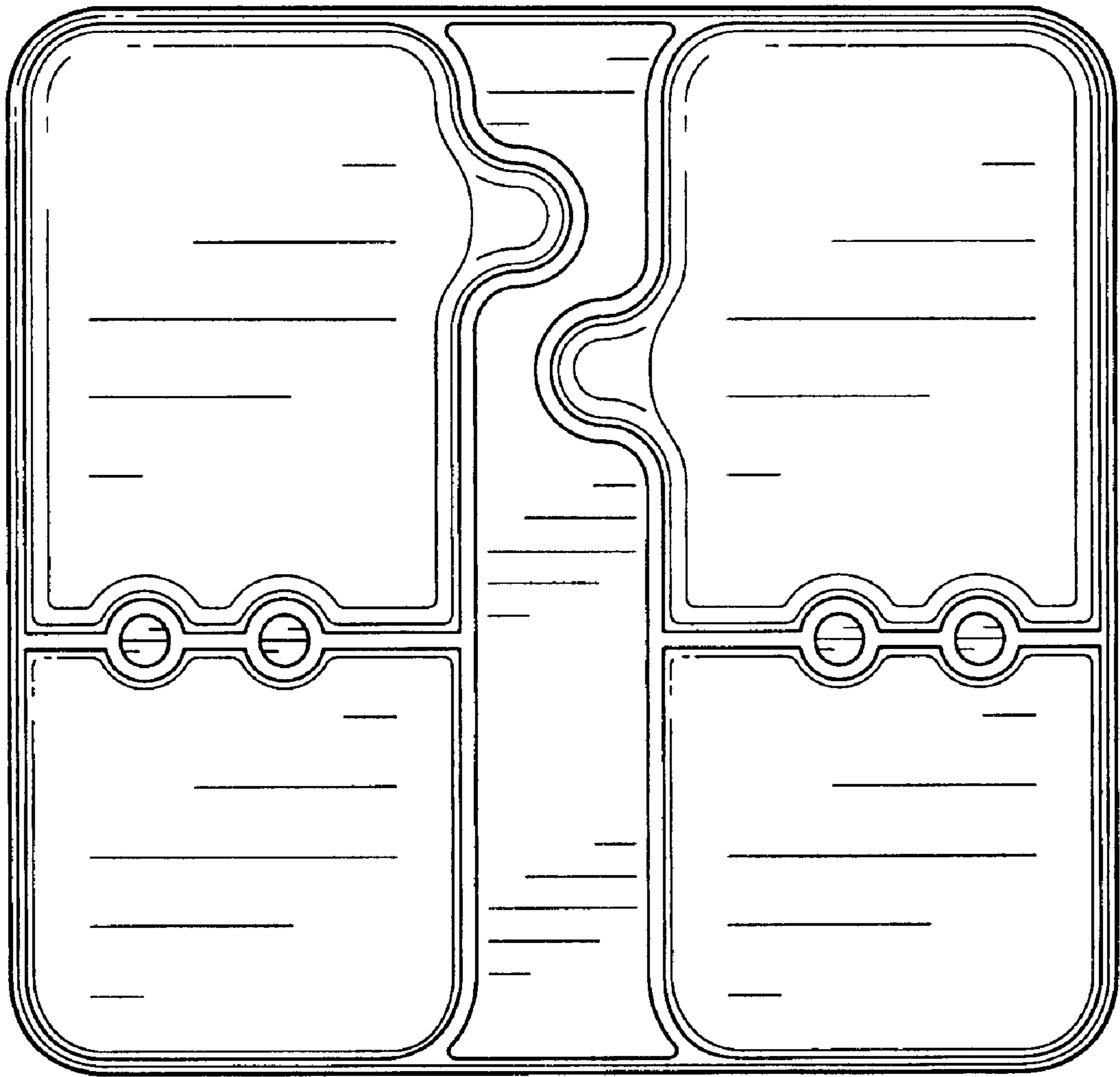

FIG. 11



FIG. 12



FIG. 13

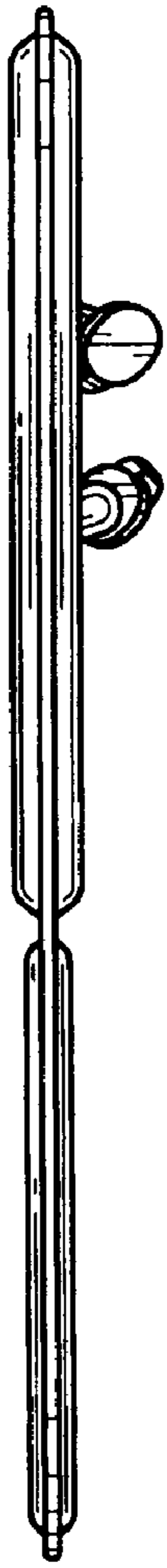

FIG. 14



FIG. 15

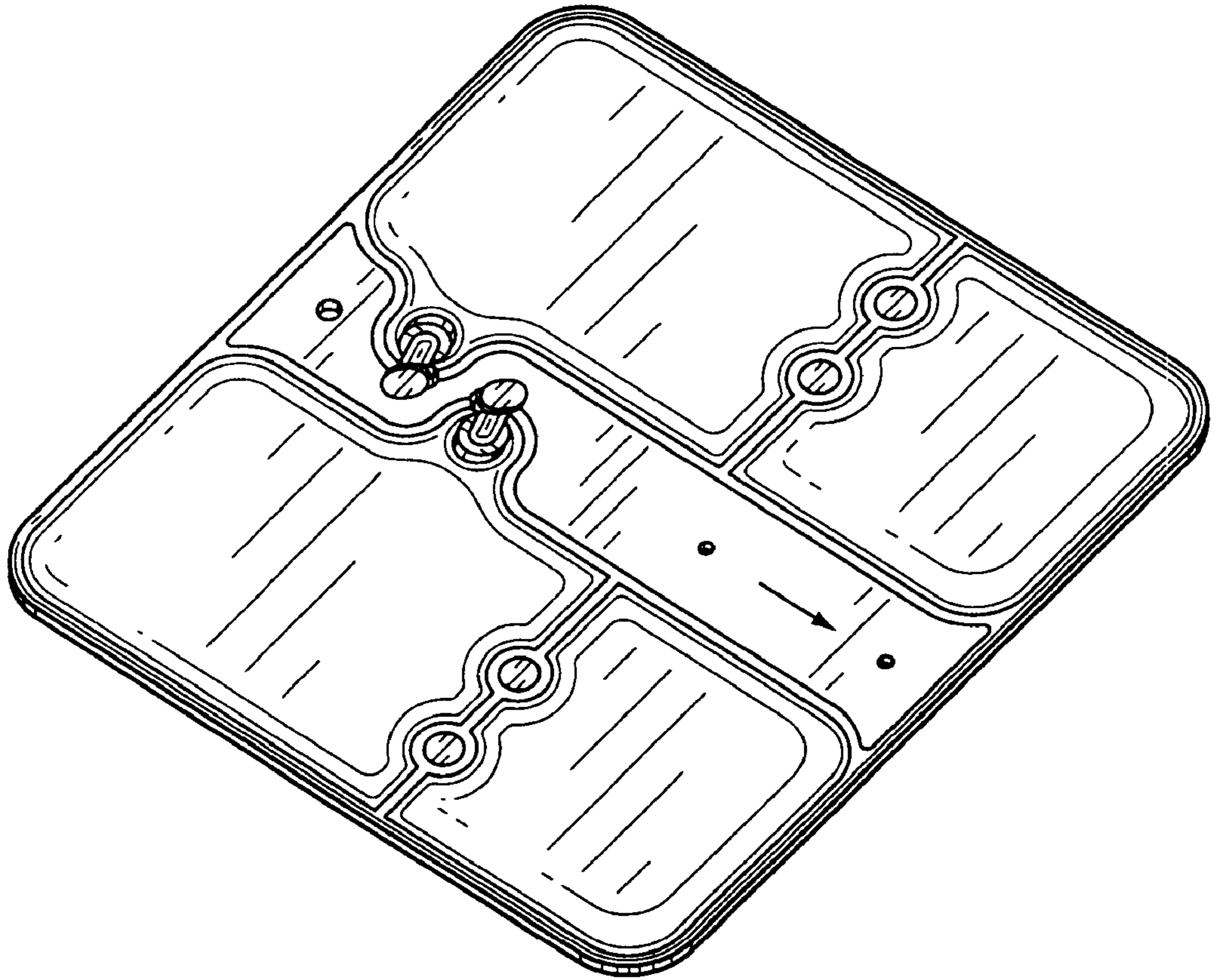

FIG. 16