



US00D471459S

(12) **United States Design Patent**  
**Denham et al.**

(10) **Patent No.:** **US D471,459 S**

(45) **Date of Patent:** **\*\* Mar. 11, 2003**

(54) **BOTTLE INCLUDING CAP**

(75) Inventors: **Jonathan George Denham**, Cincinnati, OH (US); **James Edward McCay**, Fairfield, CT (US); **Gregory Alan Zimmer**, Cincinnati, OH (US)

(73) Assignee: **The Procter & Gamble Company**, Cincinnati, OH (US)

(\*\*) Term: **14 Years**

(21) Appl. No.: **29/128,194**

(22) Filed: **Aug. 18, 2000**

(51) **LOC (7) Cl.** ..... **09-01**

(52) **U.S. Cl.** ..... **D9/515; D9/529; D9/530; D9/543; D9/559**

(58) **Field of Search** ..... D9/500, 504, 514, D9/509, 515, 516, 520, 527, 529, 530, 531, 561, 571, 494, 445, 447, 450, 453, 454; 215/381-384, 396, 398; 222/565

(56) **References Cited**

**U.S. PATENT DOCUMENTS**

D189,372 S	*	11/1960	Adell	.....	D9/561
D198,341 S	*	6/1964	Warden	.....	D9/529
D210,115 S	*	2/1968	Armour	.....	D9/521
D214,263 S	*	5/1969	McConnell	.....	D9/450
D217,227 S	*	4/1970	Christiansen	.....	D9/543
D223,142 S	*	3/1972	Koenigsberg	.....	D9/529
D229,723 S	*	12/1973	Grimes	.....	D9/512
D233,737 S	*	11/1974	Beaver	.....	D9/531
4,134,510 A	*	1/1979	Chang	.....	215/373
D256,430 S	*	8/1980	Pena	.....	D9/531
D387,278 S	*	12/1997	Olivares et al.	.....	D9/541
D432,021 S	*	10/2000	Caughey et al.	.....	D9/543
D434,327 S	*	11/2000	Di Bartolo et al.	.....	D9/523
D435,795 S	*	1/2001	Bretz et al.	.....	D9/520

\* cited by examiner

*Primary Examiner*—Ted Shooman  
*Assistant Examiner*—Carol Rademaker

(74) *Attorney, Agent, or Firm*—Ian S. Robinson; Thibault Fayette; Kim William Zerby

(57) **CLAIM**

The ornamental design for a bottle including cap, as shown and described.

**DESCRIPTION**

FIG. 1 is a perspective view of a bottle including cap embodying the design;  
 FIG. 2 is a top plan of a bottle including cap embodying the design shown in FIG. 1;  
 FIG. 3 is a side view of a bottle including cap embodying the design shown in FIG. 1, the reverse side of the bottle being a mirror image thereof;  
 FIG. 4 is a rear view of a bottle including cap embodying the design shown in FIG. 1;  
 FIG. 5 is a front view of a bottle including cap embodying the design shown in FIG. 1;  
 FIG. 6 is bottom view of a bottle embodying the design shown in FIG. 1;  
 FIG. 7 is a perspective view of a second embodiment of a transparent bottle including cap embodying the design;  
 FIG. 8 is a top plan of a transparent bottle including cap embodying the design shown in FIG. 7;  
 FIG. 9 is a side view of a transparent bottle including cap embodying the design shown in FIG. 7, the reverse side of the bottle being a mirror image thereof;  
 FIG. 10 is a rear view of a transparent bottle including cap embodying the design shown in FIG. 7;  
 FIG. 11 is a front view of a transparent bottle including cap embodying the design shown in FIG. 7; and,  
 FIG. 12 is bottom view of a transparent bottle embodying the design shown in FIG. 7.

The broken lines shown in FIGS. 6, 7, 8 and 12 are for illustrative purposes only and form no part of the claimed design.

**1 Claim, 2 Drawing Sheets**

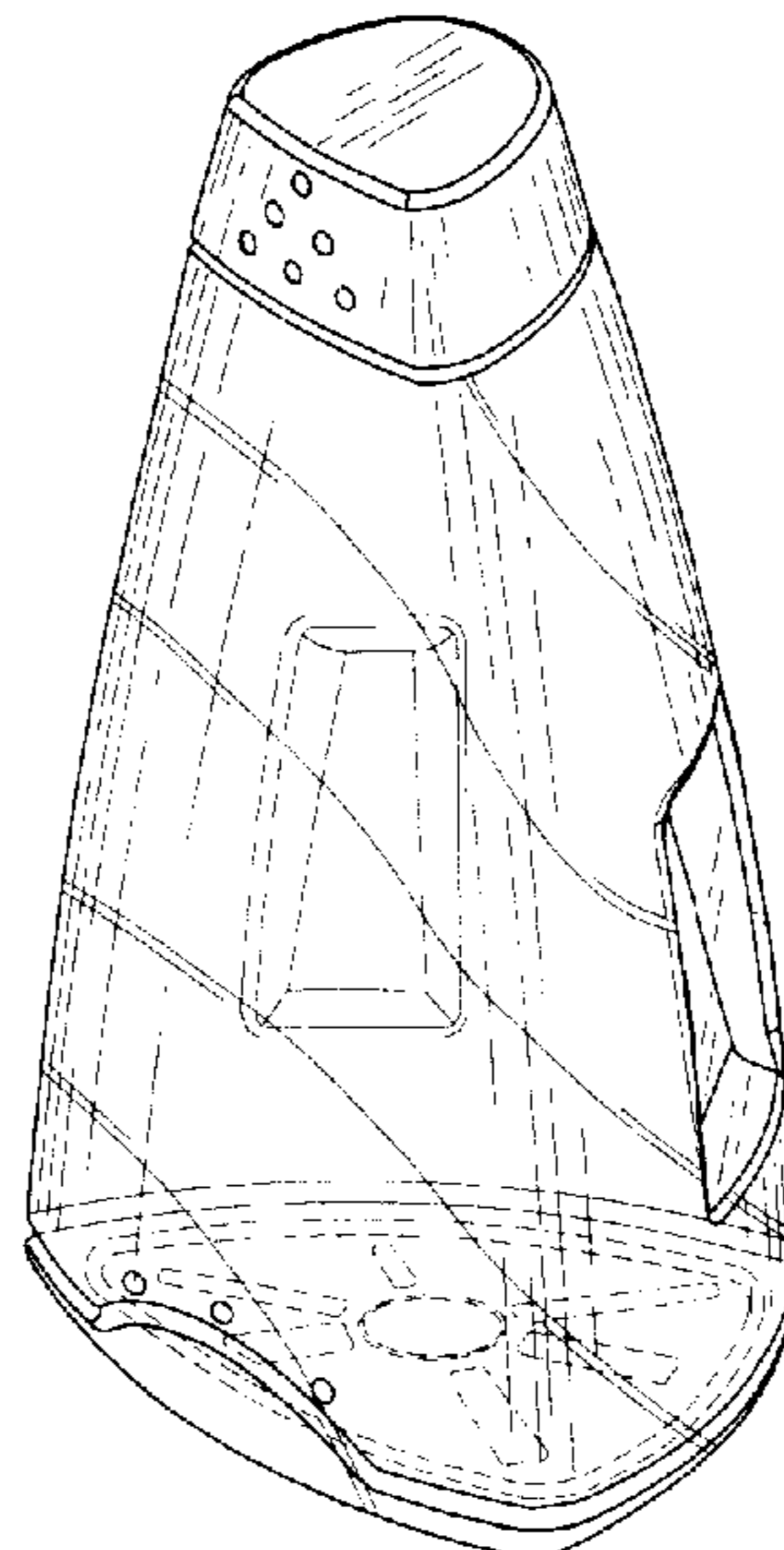
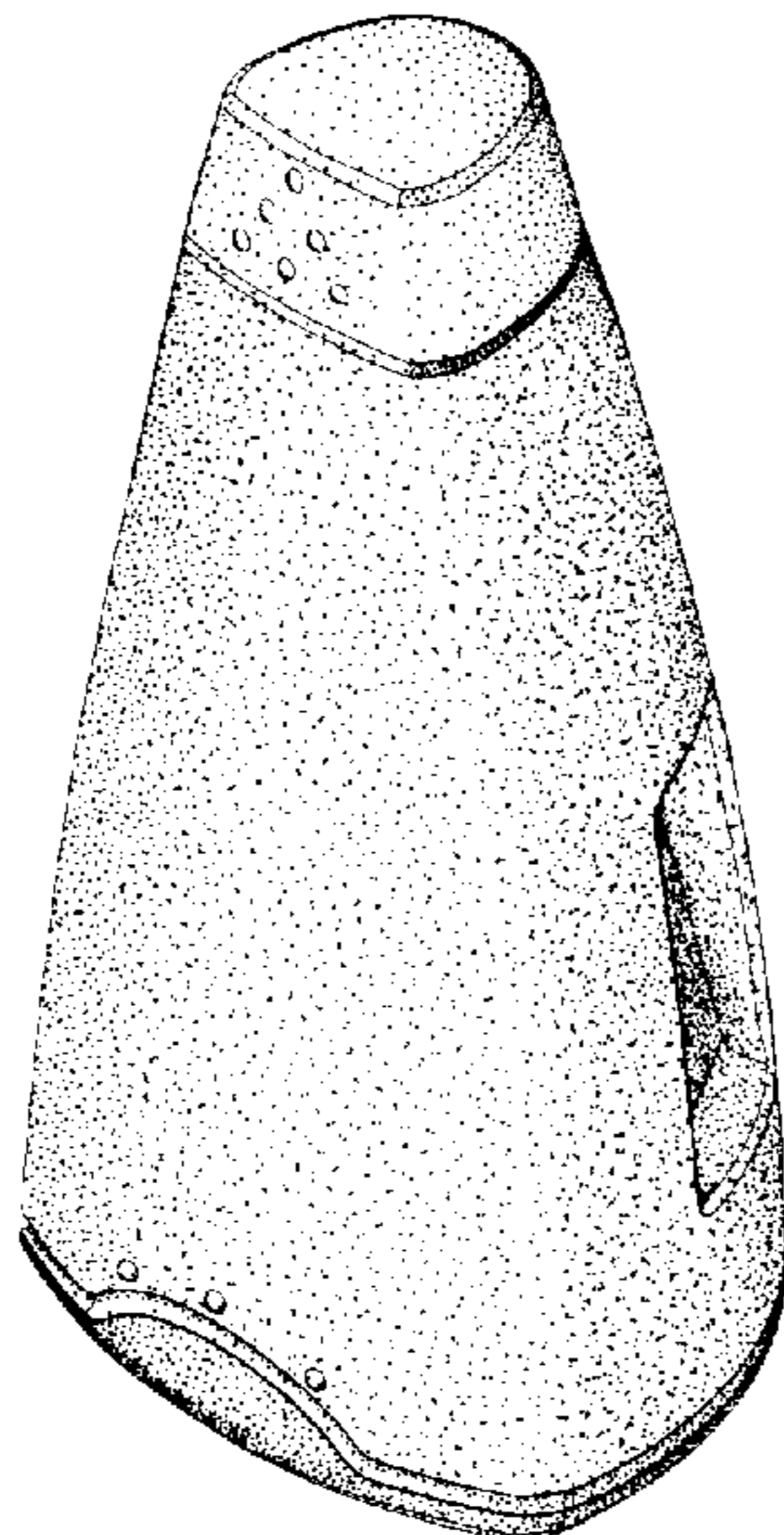

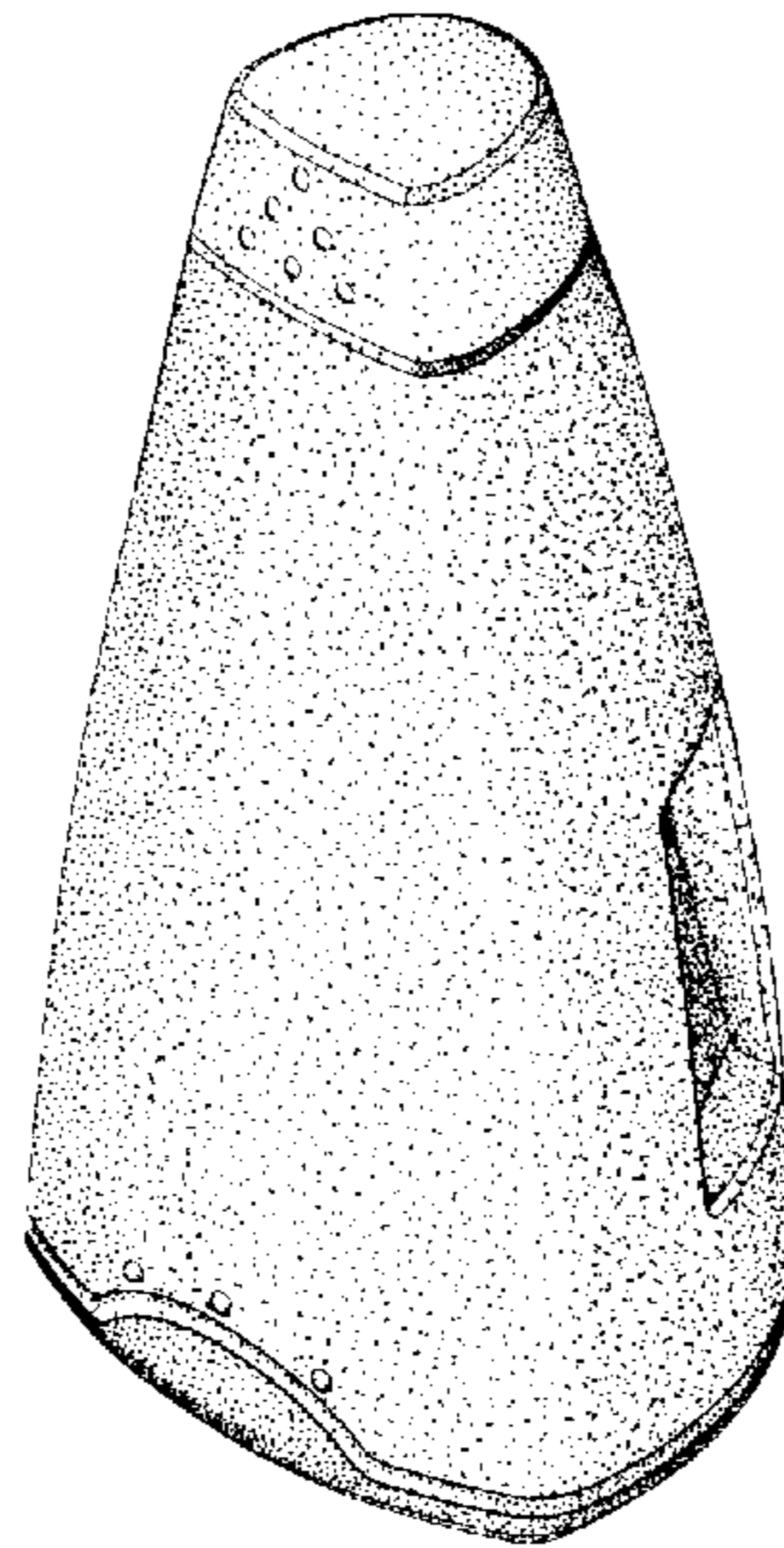

Fig. 1

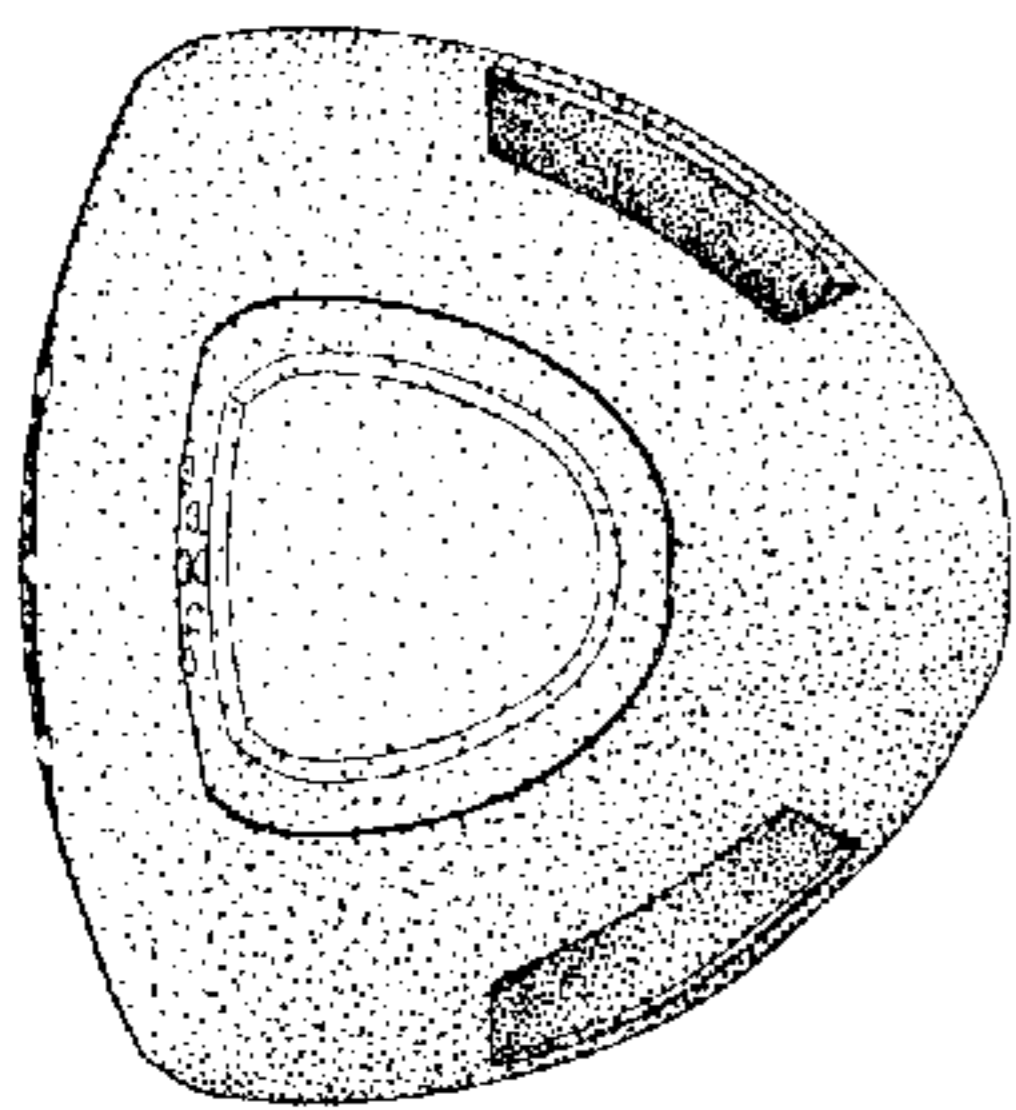

Fig. 2

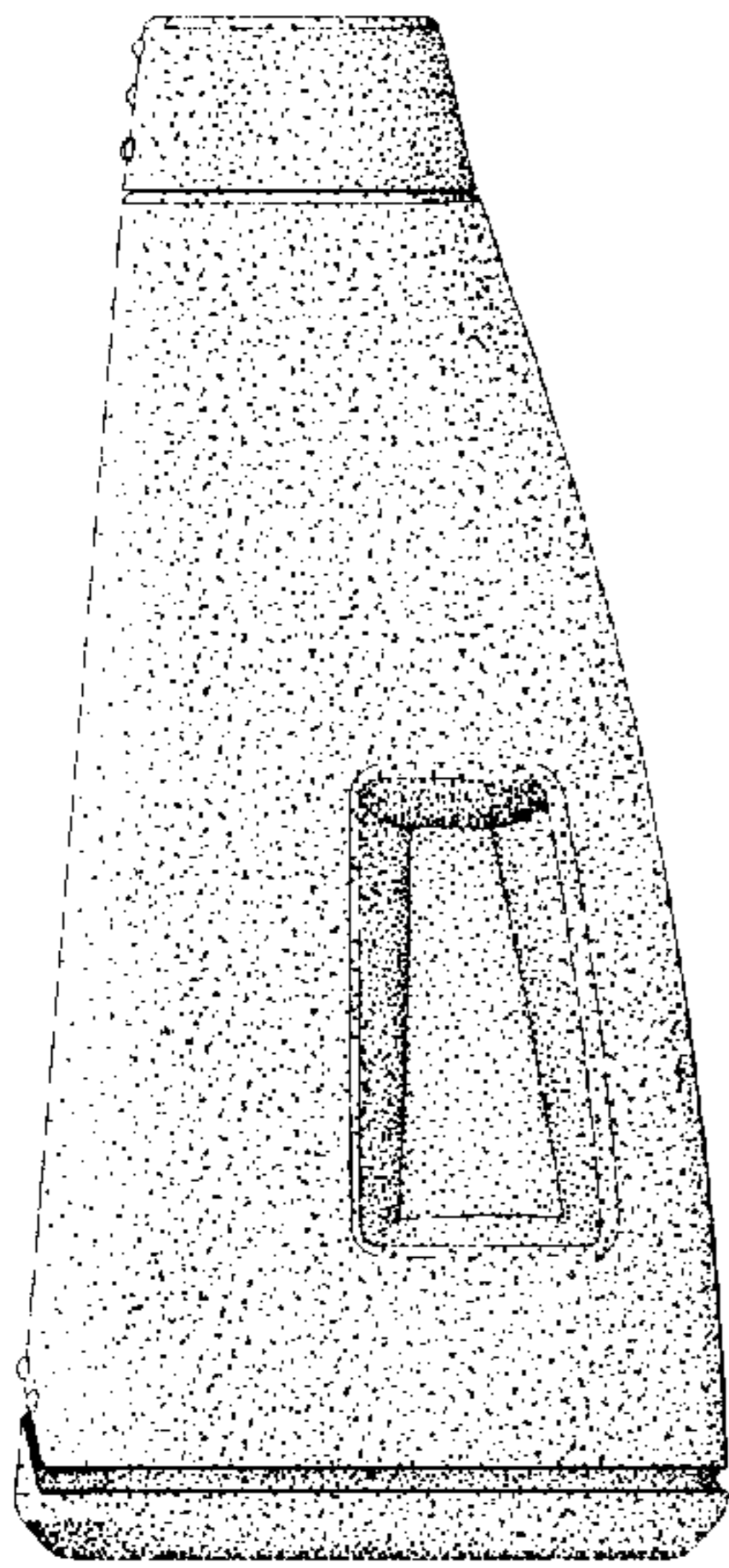

Fig. 3

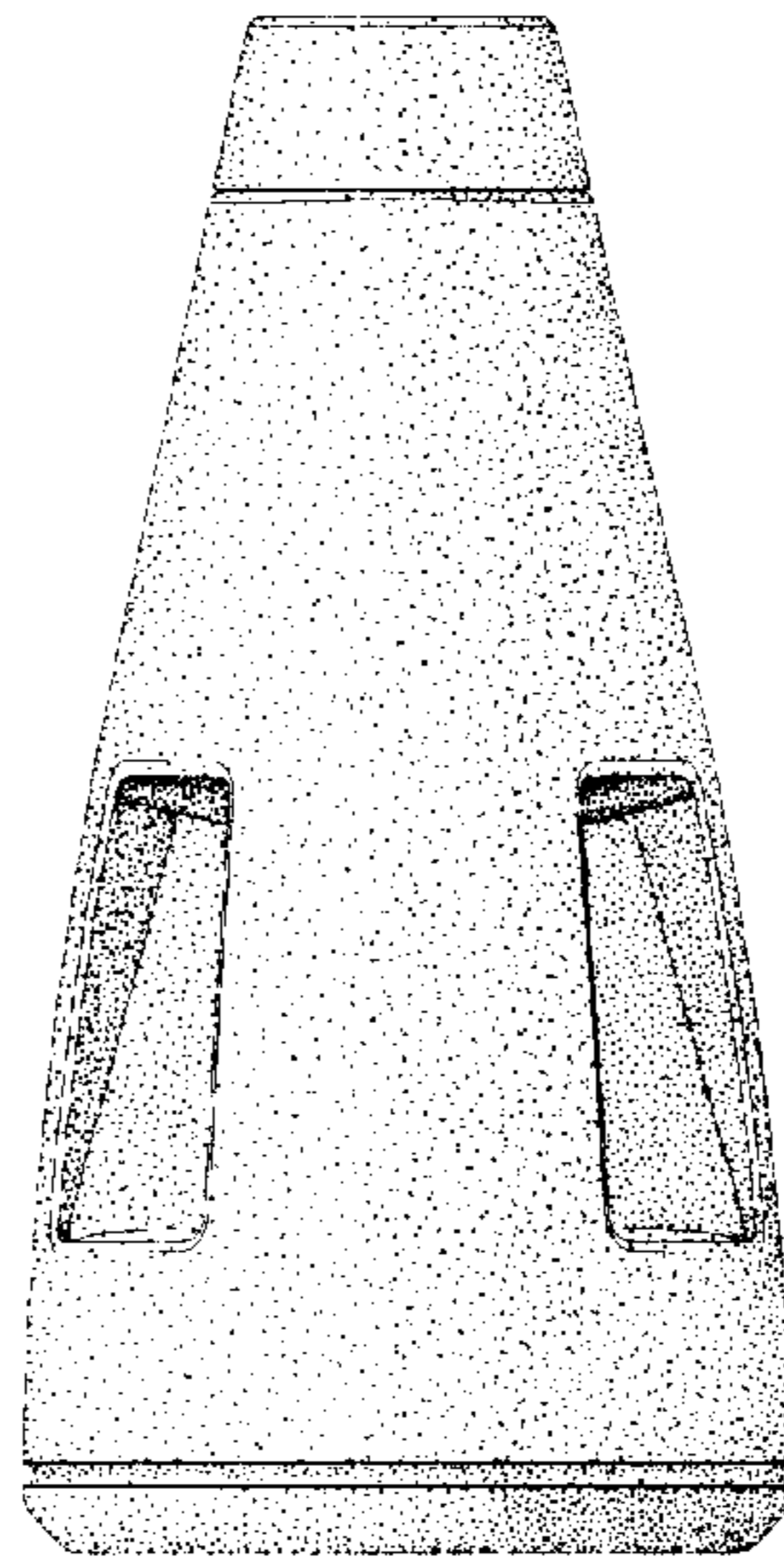

Fig. 4

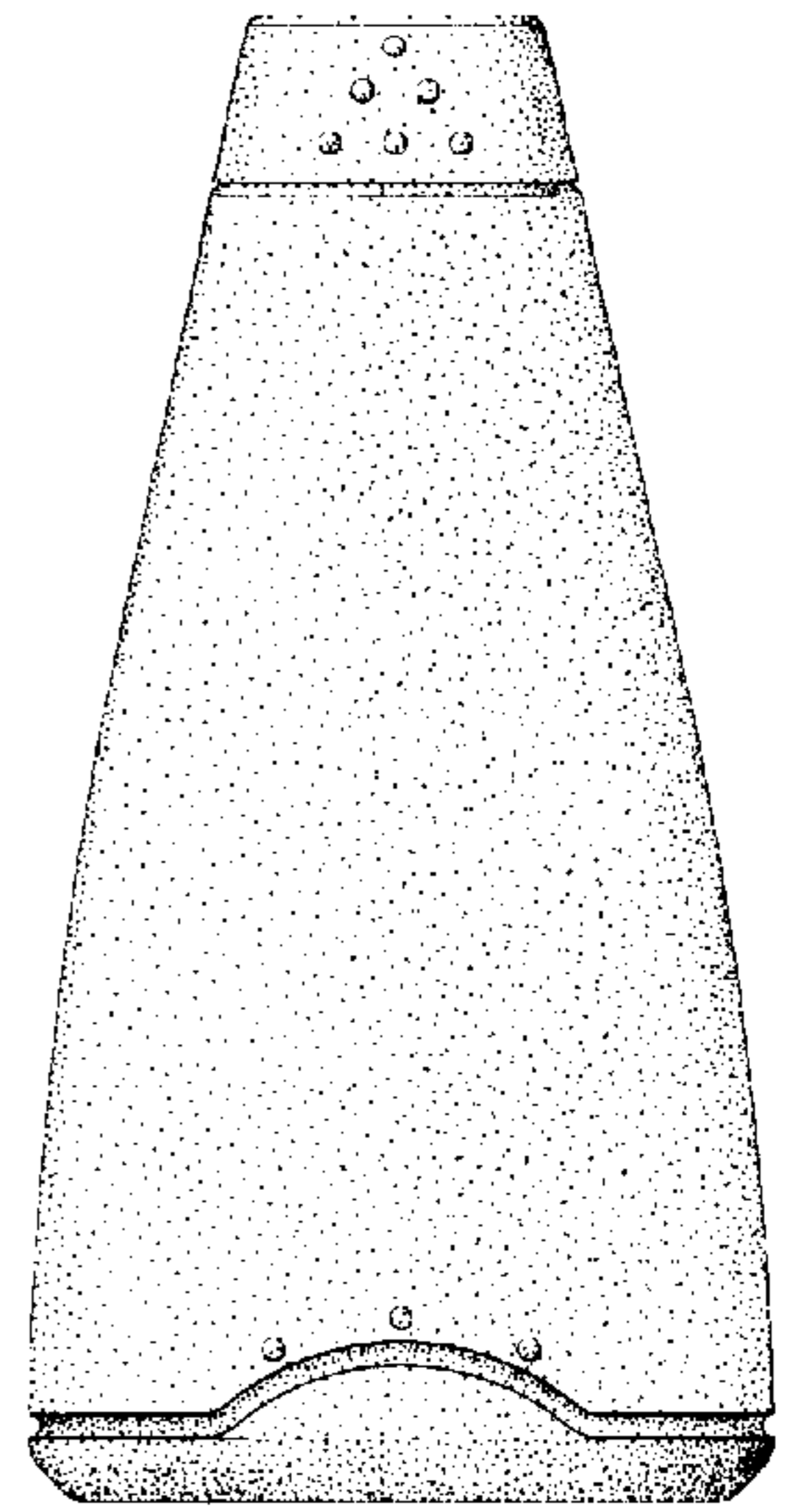

Fig. 5

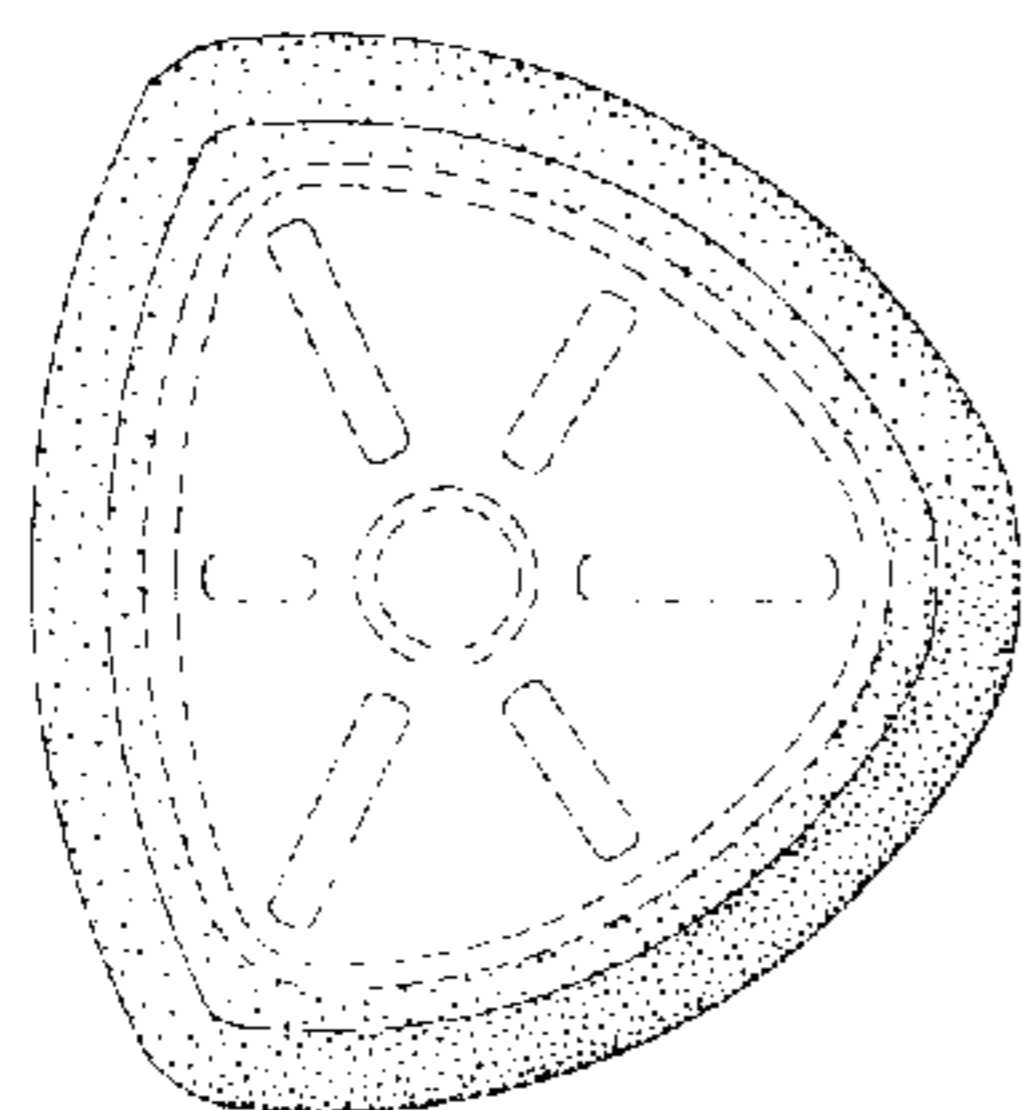

Fig. 6

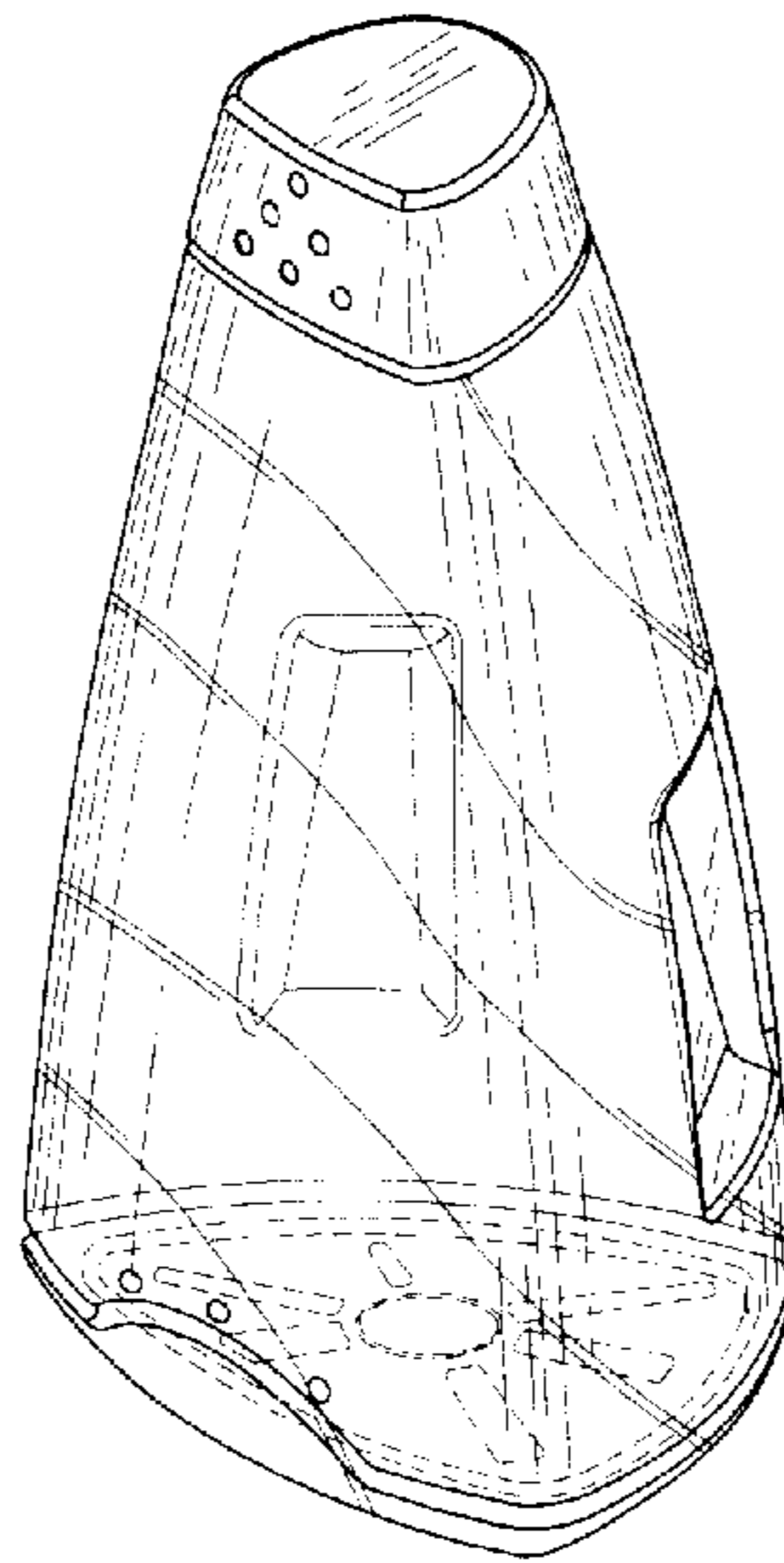

Fig. 7

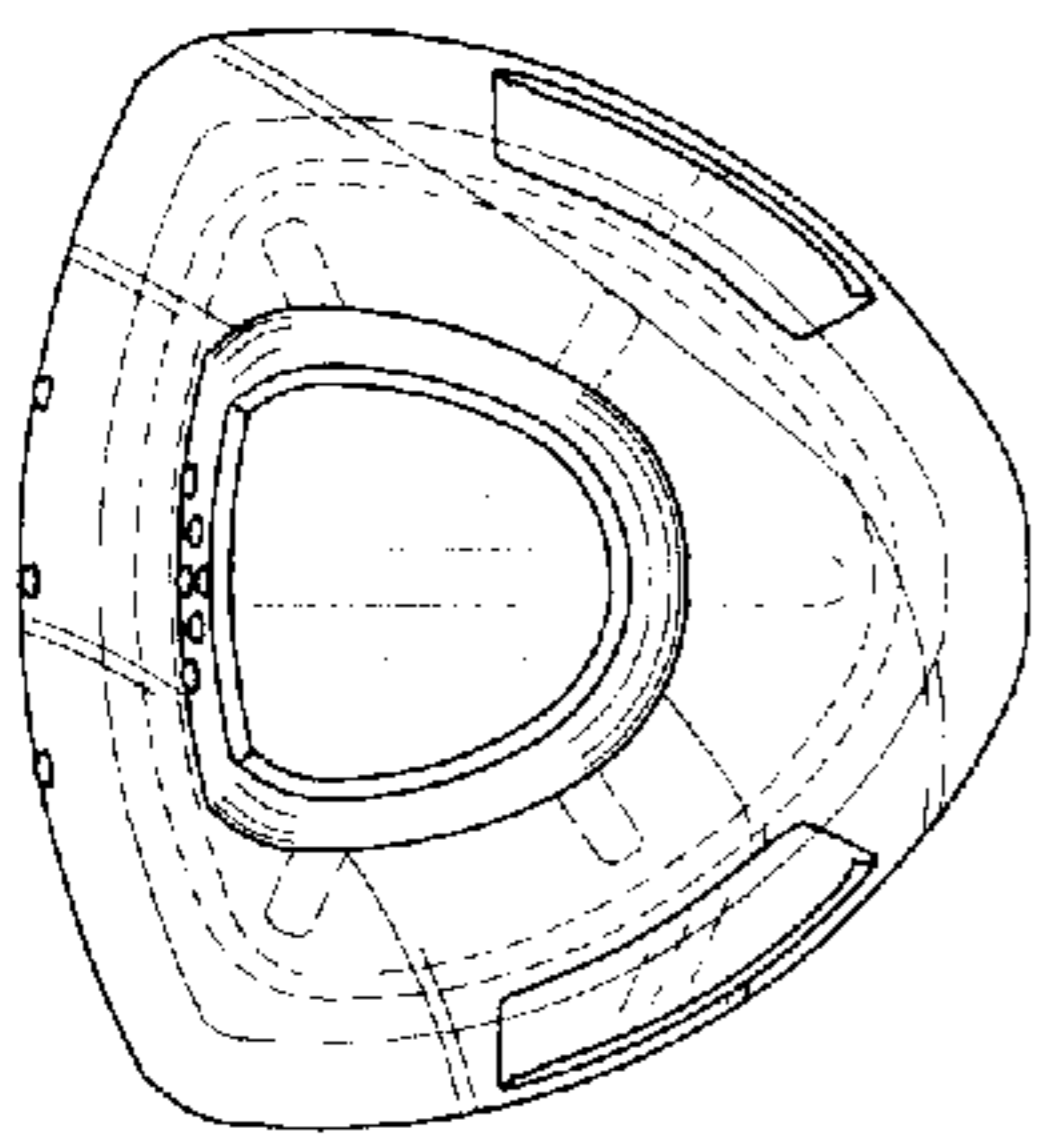

Fig. 8

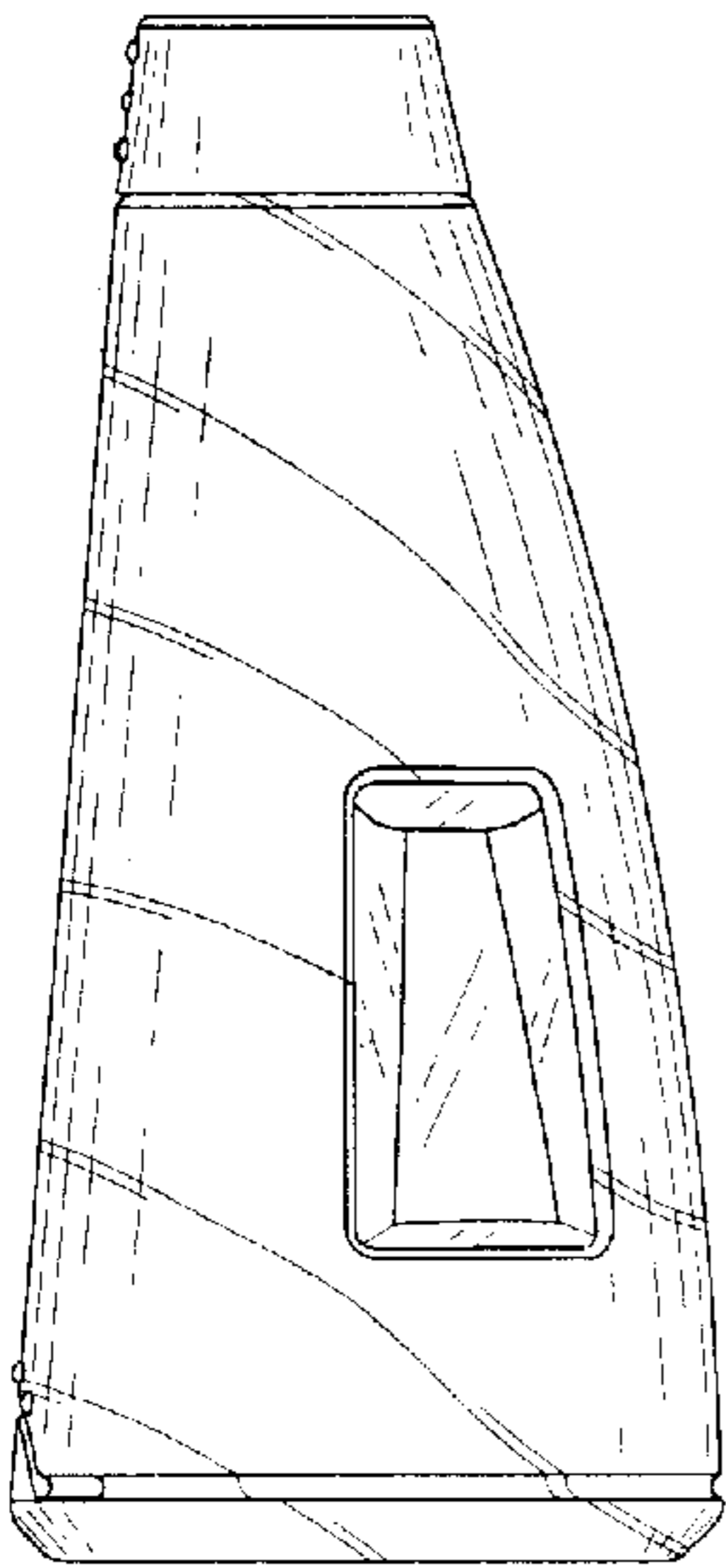

Fig. 9

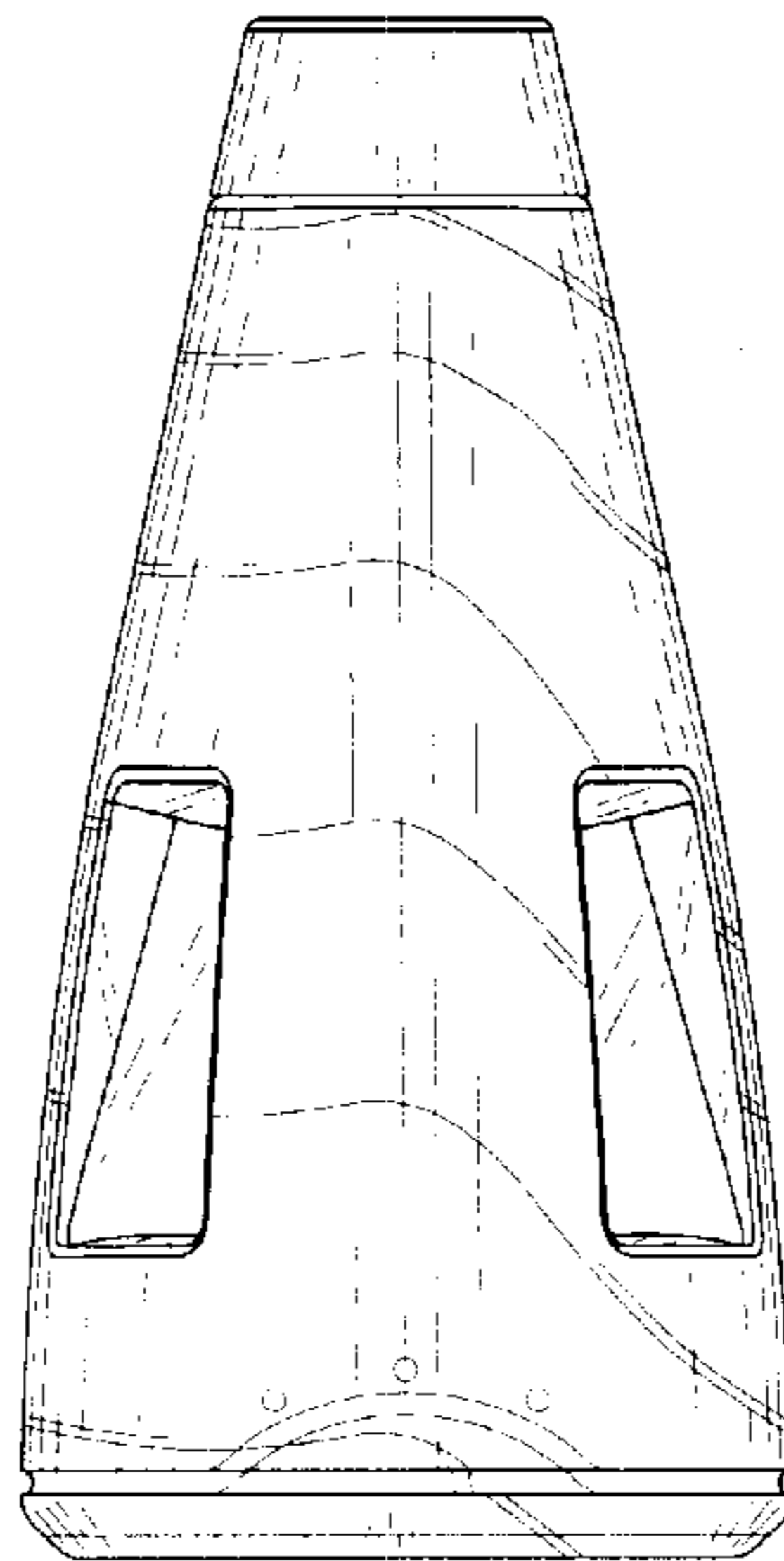

Fig. 10

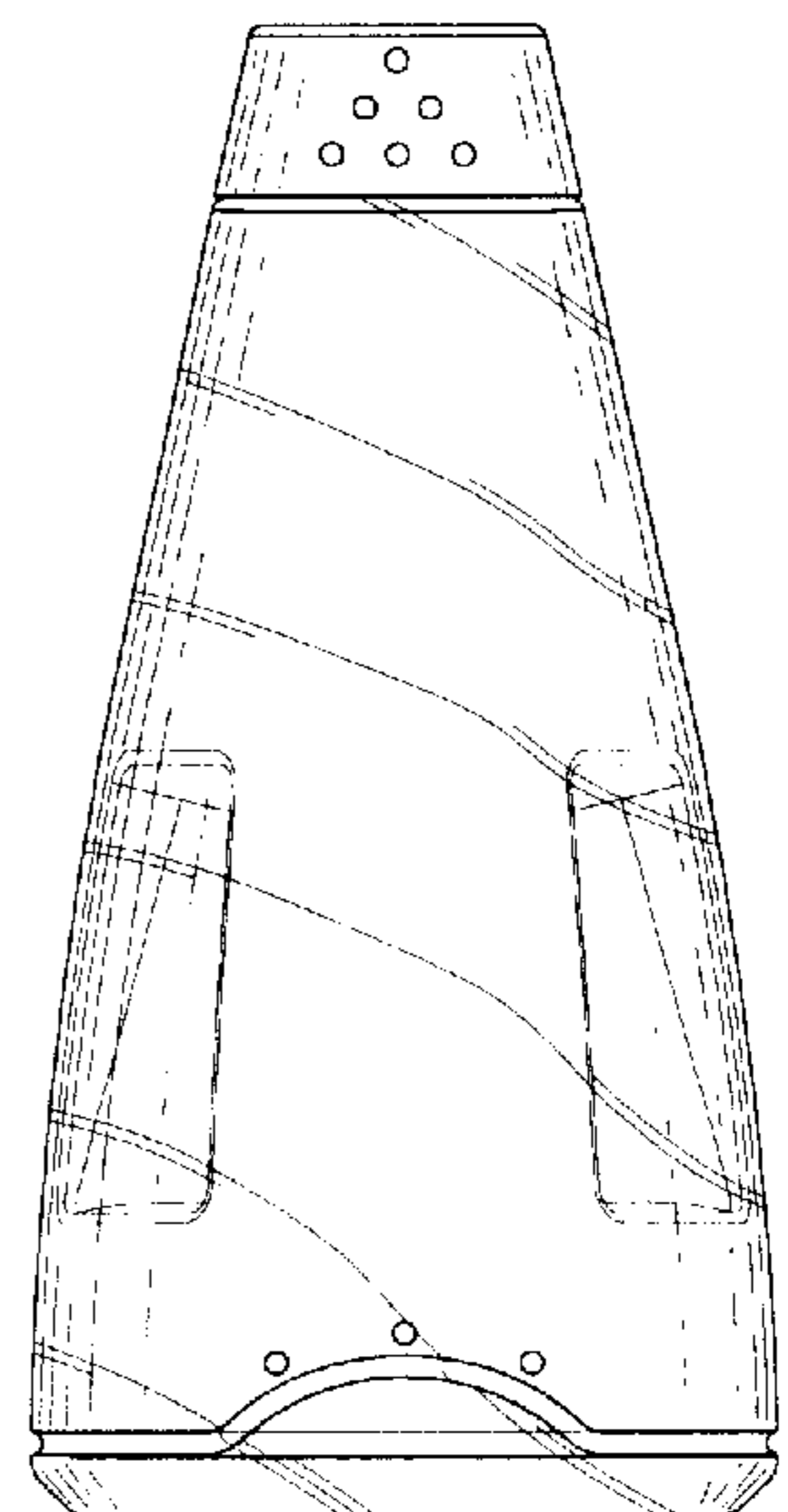

Fig. 11

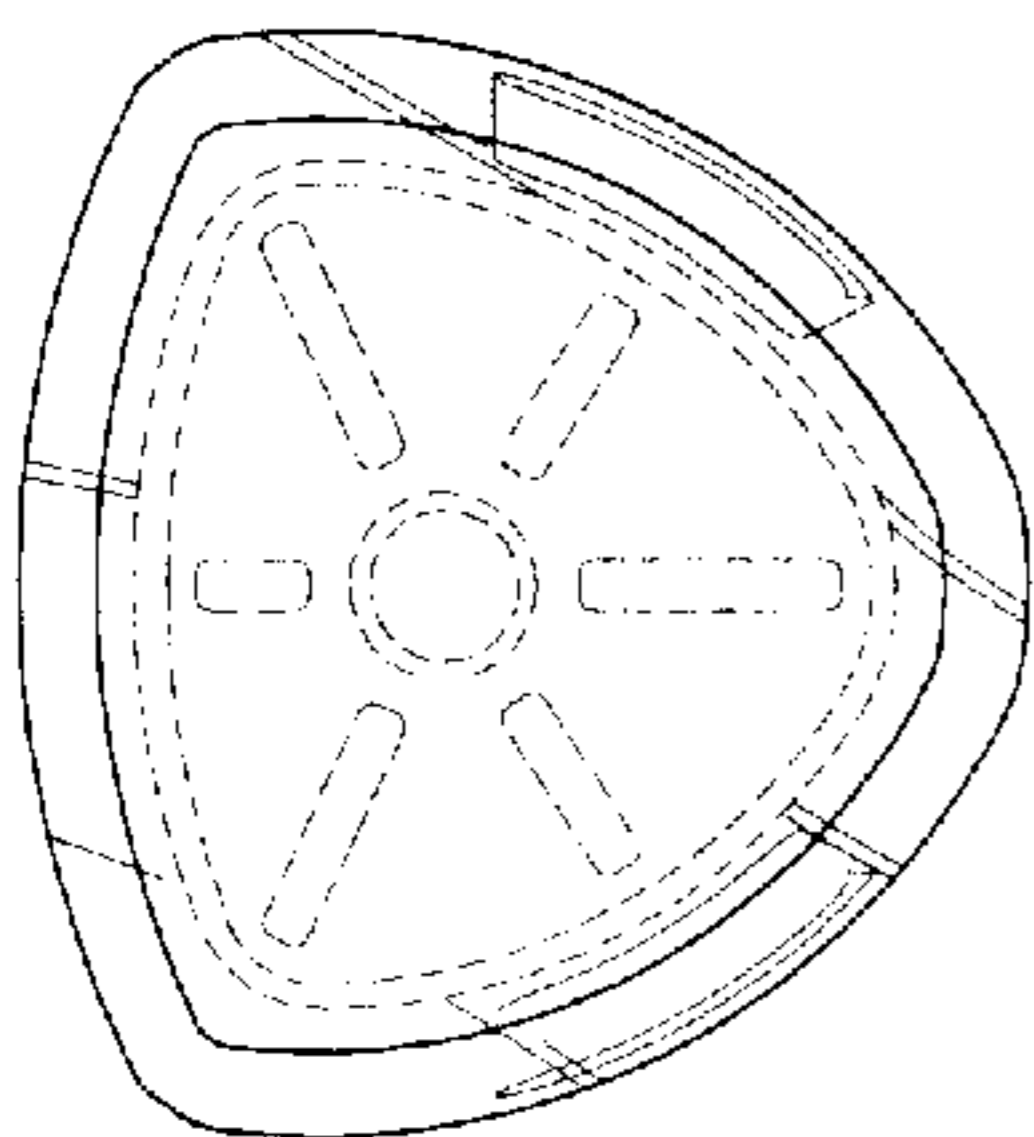

Fig. 12