



US00D471324S

(12) **United States Design Patent**
Kalin

(10) **Patent No.:** **US D471,324 S**

(45) **Date of Patent:** **** Mar. 4, 2003**

(54) **LIPSTICK HOLDER WITH REFLECTIVE SURFACE**

(76) **Inventor:** **Michelle Kalin**, 1676 E. Hermosa Dr., Highlands Ranch, CO (US) 80126

(**) **Term:** **14 Years**

(21) **Appl. No.:** **29/162,219**

(22) **Filed:** **Jun. 11, 2002**

(51) **LOC (7) Cl.** **28-02**

(52) **U.S. Cl.** **D28/85; D28/77**

(58) **Field of Search** D28/7, 76, 77, D28/85-90; D9/337, 338, 529, 559-561, 567; 132/317, 318, 320; 206/385, 581, 823; 401/52, 55-98

(56) **References Cited**

U.S. PATENT DOCUMENTS

D72,687 S	*	5/1927	Vionnet	D9/560
1,947,738 A	*	2/1934	Reutter	401/75
2,333,889 A	*	11/1943	Ruekberg	401/78
2,456,948 A	*	12/1948	Kaye	132/316
D156,259 S	*	11/1949	Livermore	D28/77

(List continued on next page.)

OTHER PUBLICATIONS

Harper's Bazaar, Oct. 1985, p. 135: Yves Saint Laurent lipstick case and cap.*

(List continued on next page.)

Primary Examiner—Ted Shooman

Assistant Examiner—C Tuttle

(74) *Attorney, Agent, or Firm*—Holland & Hart

(57) **CLAIM**

The ornamental design for a lipstick holder with reflective surface, as shown and described.

DESCRIPTION

FIG. 1 is a front perspective view of a lipstick holder showing our new design;

FIG. 2 is a right side elevation view thereof;
 FIG. 3 is a left side elevation view thereof;
 FIG. 4 is a rear side elevation view thereof;
 FIG. 5 is a front side elevation view thereof;
 FIG. 6 is a top plan view thereof;
 FIG. 7 is a bottom plan view thereof;
 FIG. 8 is a right side elevation view of a second embodiment;
 FIG. 9 is a left side elevation view thereof;
 FIG. 10 is a rear side elevation view thereof;
 FIG. 11 is a front side elevation view thereof;
 FIG. 12 is a right side elevation view of a third embodiment;
 FIG. 13 is a left side elevation view thereof;
 FIG. 14 is a rear side elevation view thereof;
 FIG. 15 is a front side elevation view thereof;
 FIG. 16 is a right side elevation view of a fourth embodiment;
 FIG. 17 is a left side elevation view thereof;
 FIG. 18 is a rear side elevation view thereof;
 FIG. 19 is a front side elevation view thereof;
 FIG. 20 is a front perspective view of a fifth embodiment;
 FIG. 21 is a right side elevation view thereof;
 FIG. 22 is a left side elevation view thereof;
 FIG. 23 is a rear side elevation view thereof;
 FIG. 24 is a front side elevation view thereof;
 FIG. 25 is a top plan view thereof;
 FIG. 26 is a bottom plan view thereof;
 FIG. 27 is a right side elevation view of a sixth embodiment;
 FIG. 28 is a left side elevation view thereof;
 FIG. 29 is a rear side elevation view thereof;
 FIG. 30 is a front side elevation view thereof;
 FIG. 31 is a right side elevation view of a seventh embodiment;
 FIG. 32 is a left side elevation view thereof;
 FIG. 33 is a rear side elevation view thereof;
 FIG. 34 is a front side elevation view thereof;
 FIG. 35 is a right side elevation view of an eighth embodiment;
 FIG. 36 is a left side elevation view thereof;
 FIG. 37 is a rear side elevation view thereof; and,
 FIG. 38 is a front side elevation view thereof.
 The broken line showing of the lipstick is for illustrative purposes only and forms no part of the claimed design.

1 Claim, 20 Drawing Sheets

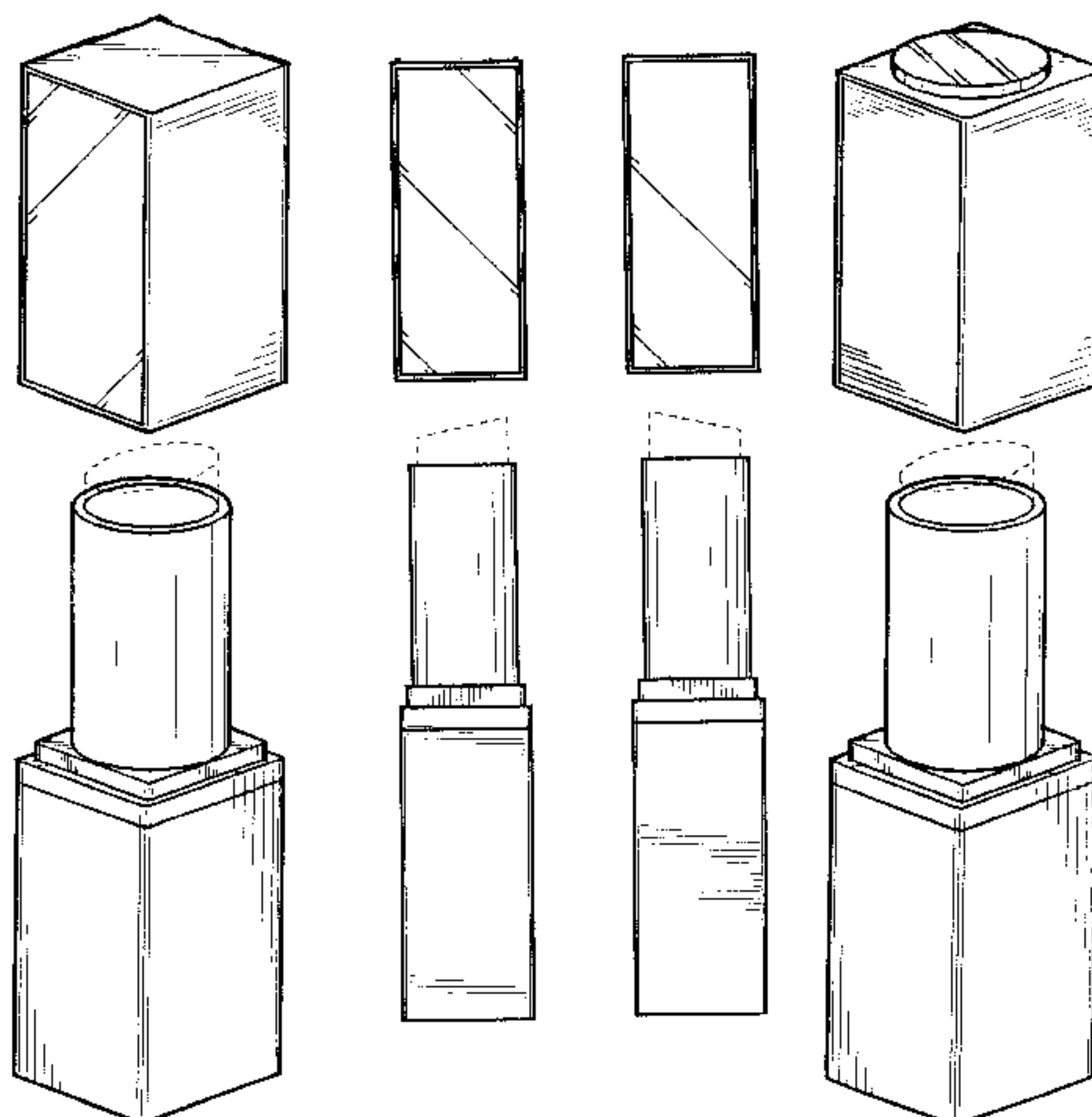

US D471,324 S

Page 2

U.S. PATENT DOCUMENTS

D180,107 S * 4/1957 Slater D28/85
5,257,696 A * 11/1993 Greene 206/385
5,599,124 A * 2/1997 Ackermann et al. 401/78
D382,369 S * 8/1997 Yang D28/85

OTHER PUBLICATIONS

Glamour, Sep. 1994, p. 47: Mabelline™ lipstick cases.*

Glamour Mar. 1994, p. 45: Mabelline™ lipstick cases.*

Harper's Bazaar, Jul. 1995, p. 139: square lipstick case at center of page.*

Adhesive Lipstick Mirrors Peel and Stick Twin Pack, Distributed by Hills Industries, 1996.

* cited by examiner

FIG. 1

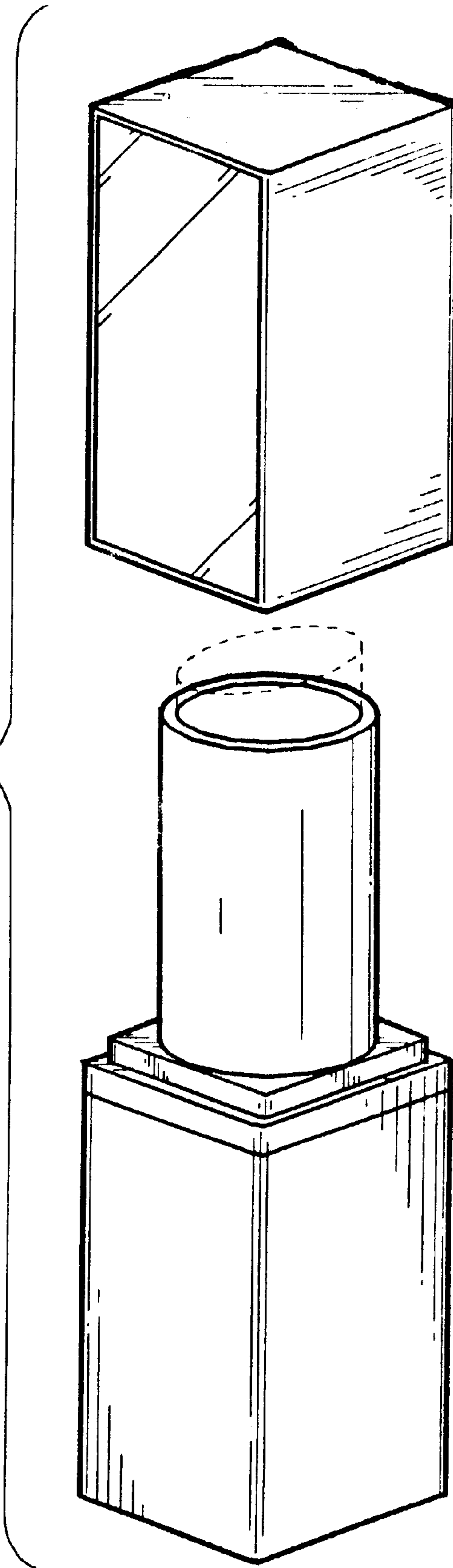

FIG.2

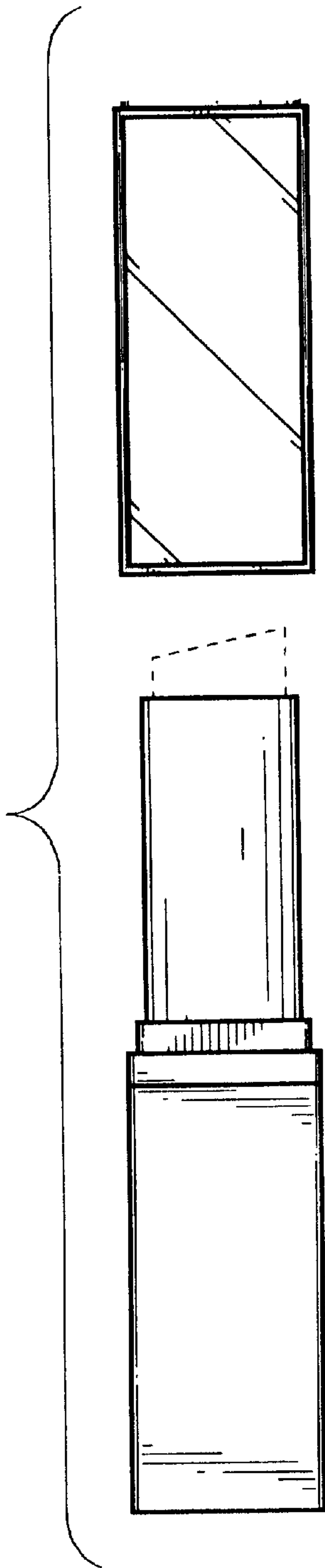

FIG.3

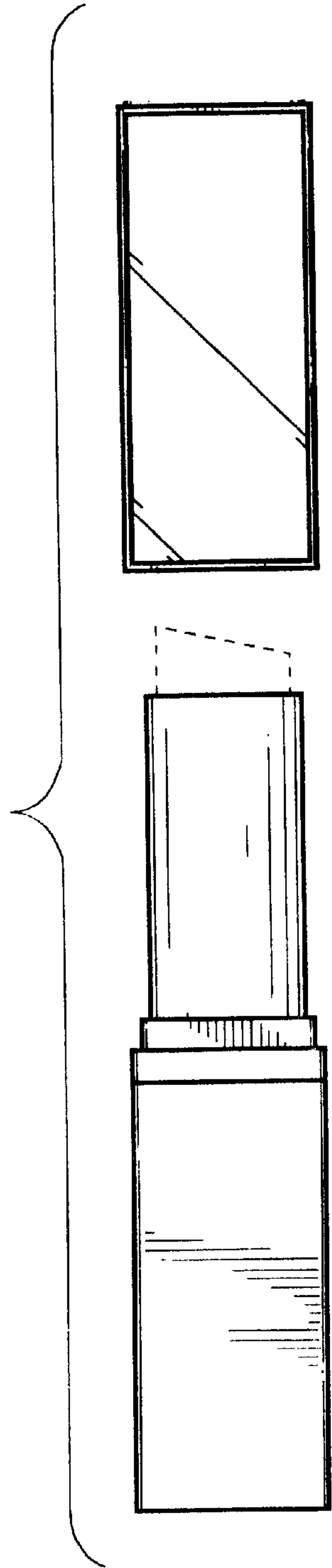

FIG.4

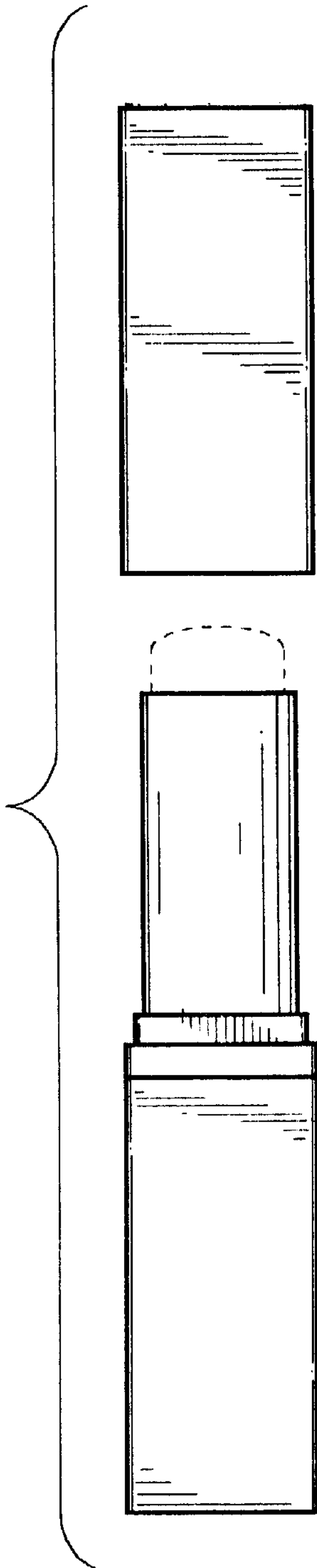
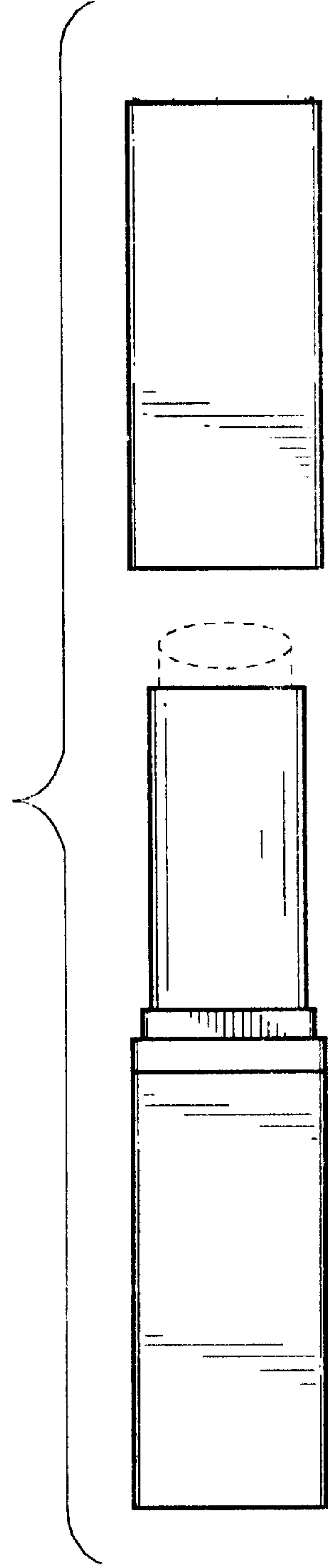

FIG.5



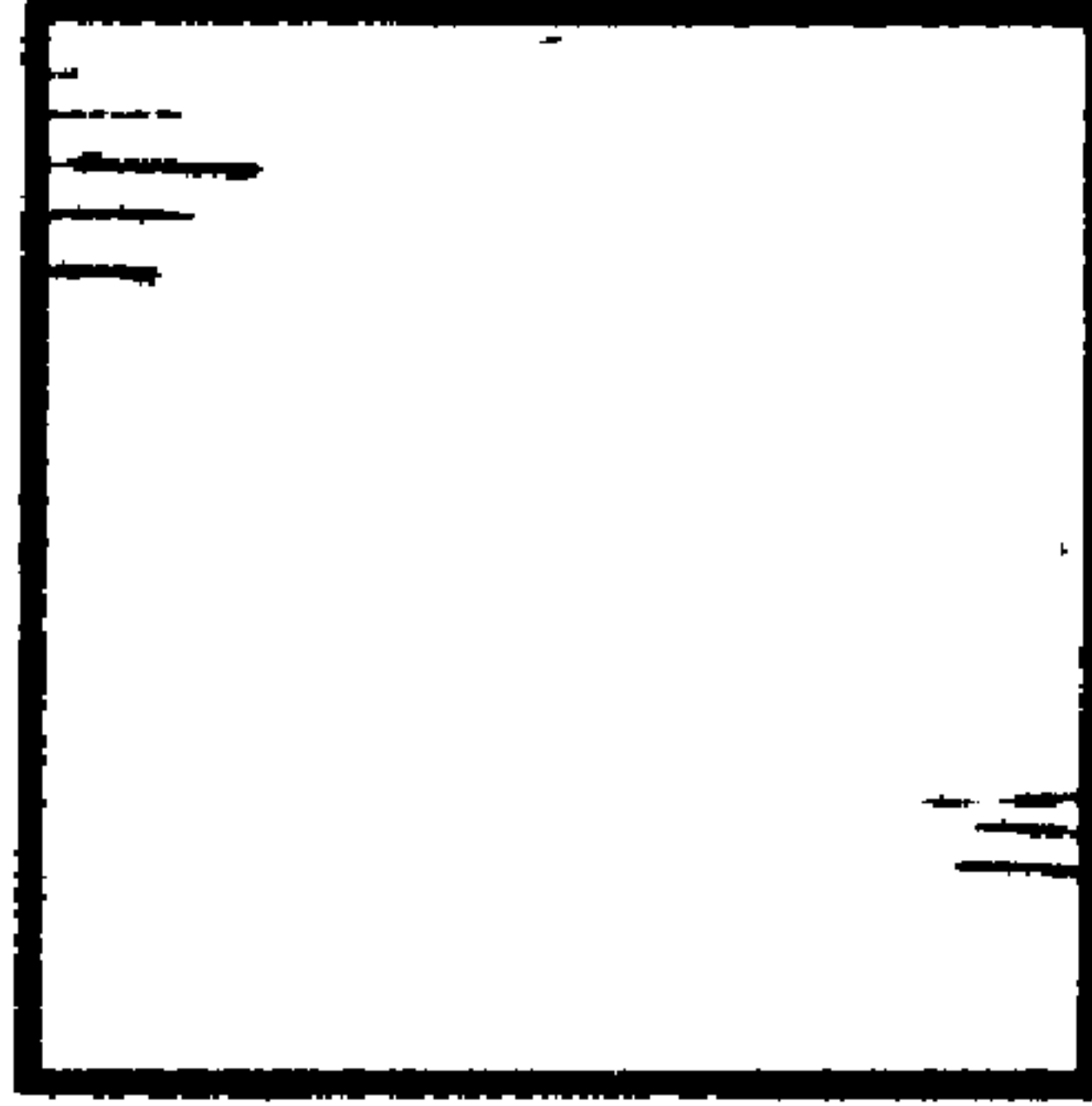

FIG. 6

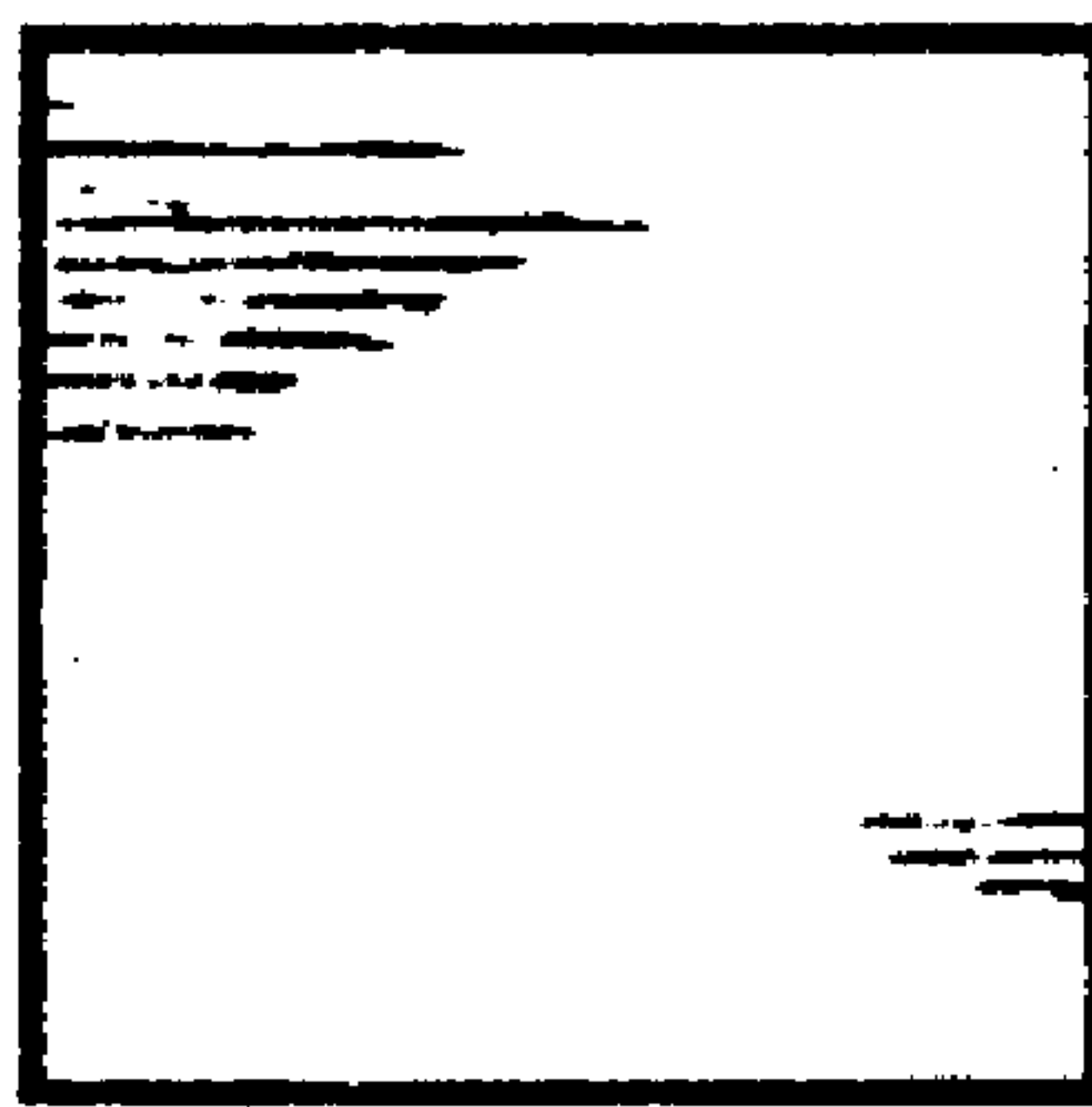

FIG. 7

FIG.8

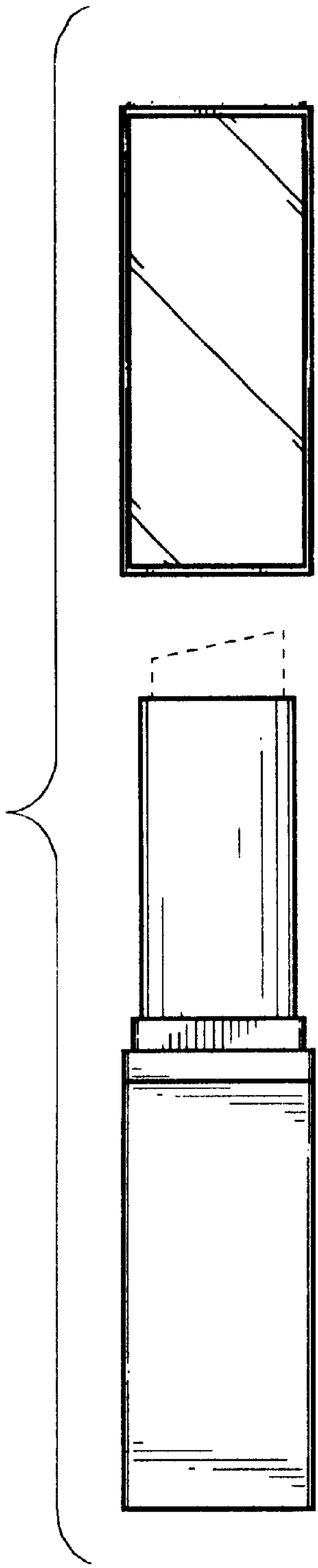

FIG.9

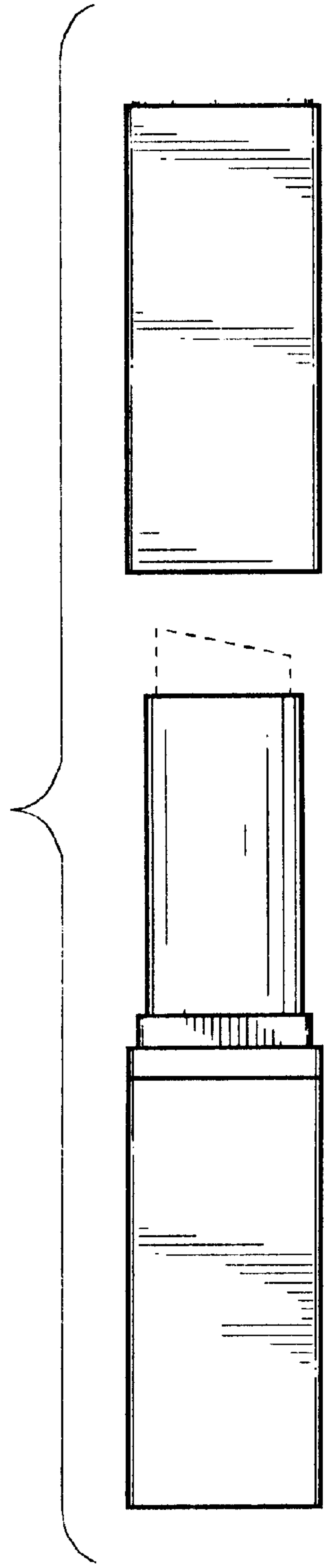

FIG.10

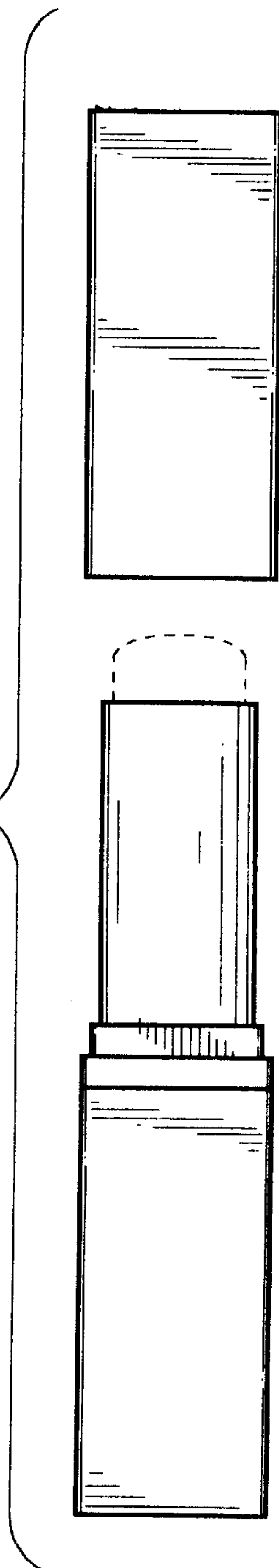

FIG.11

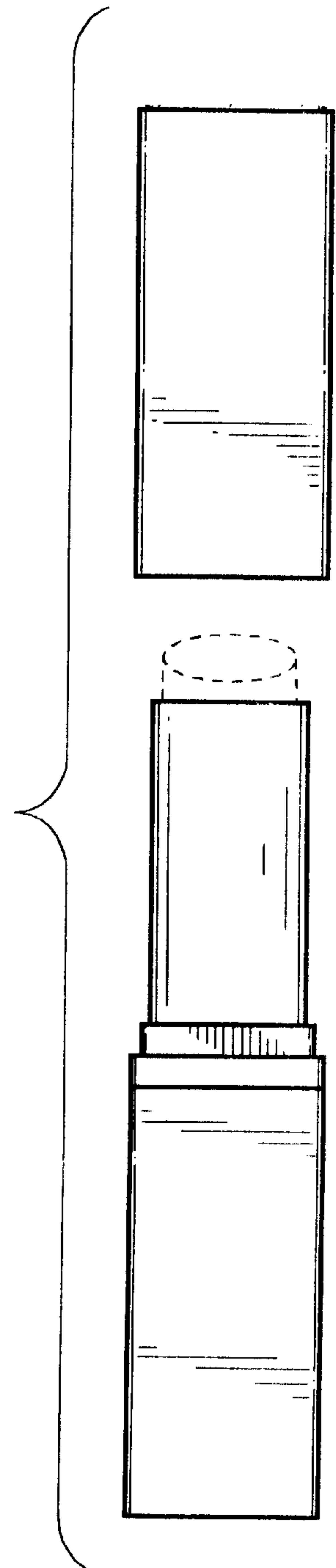

FIG.12

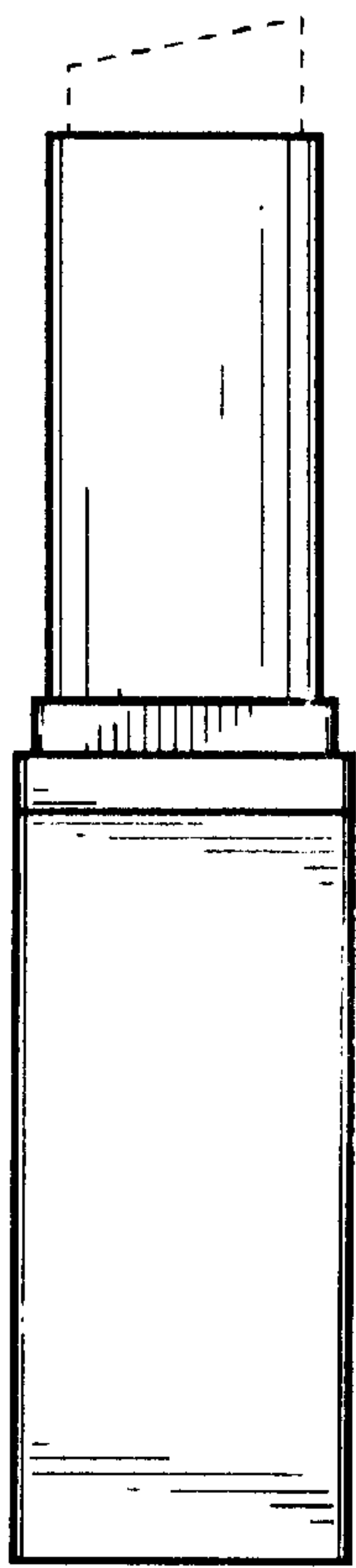
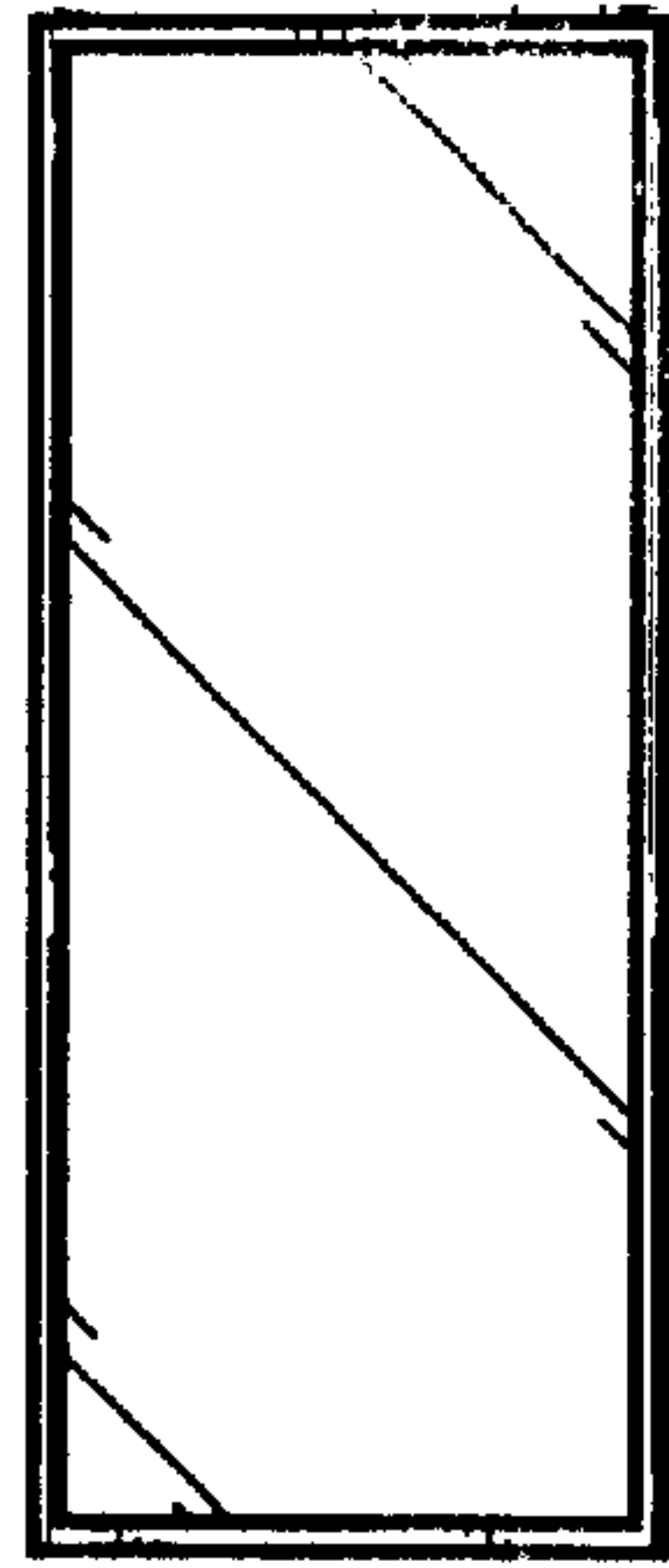

FIG.13

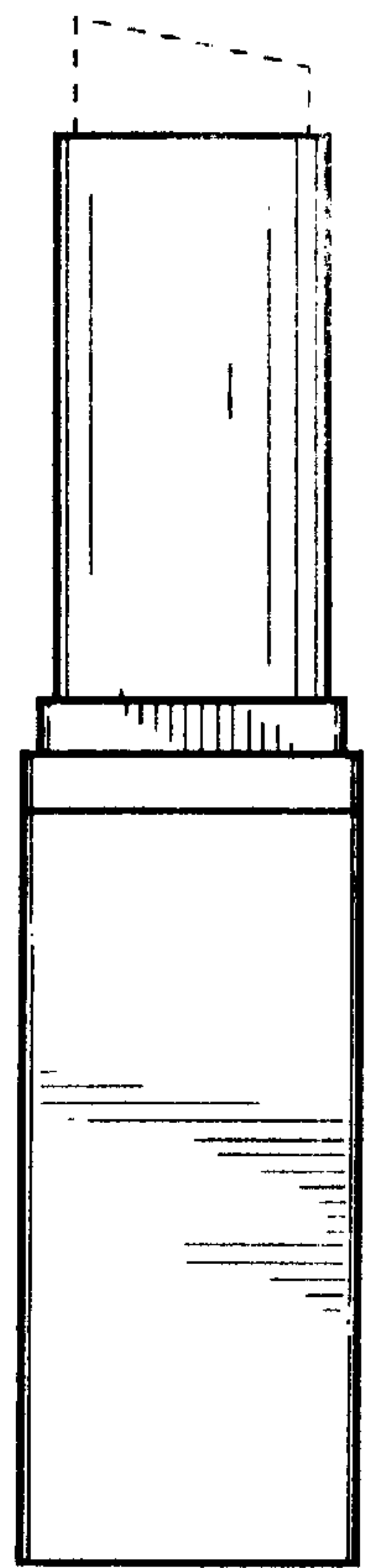
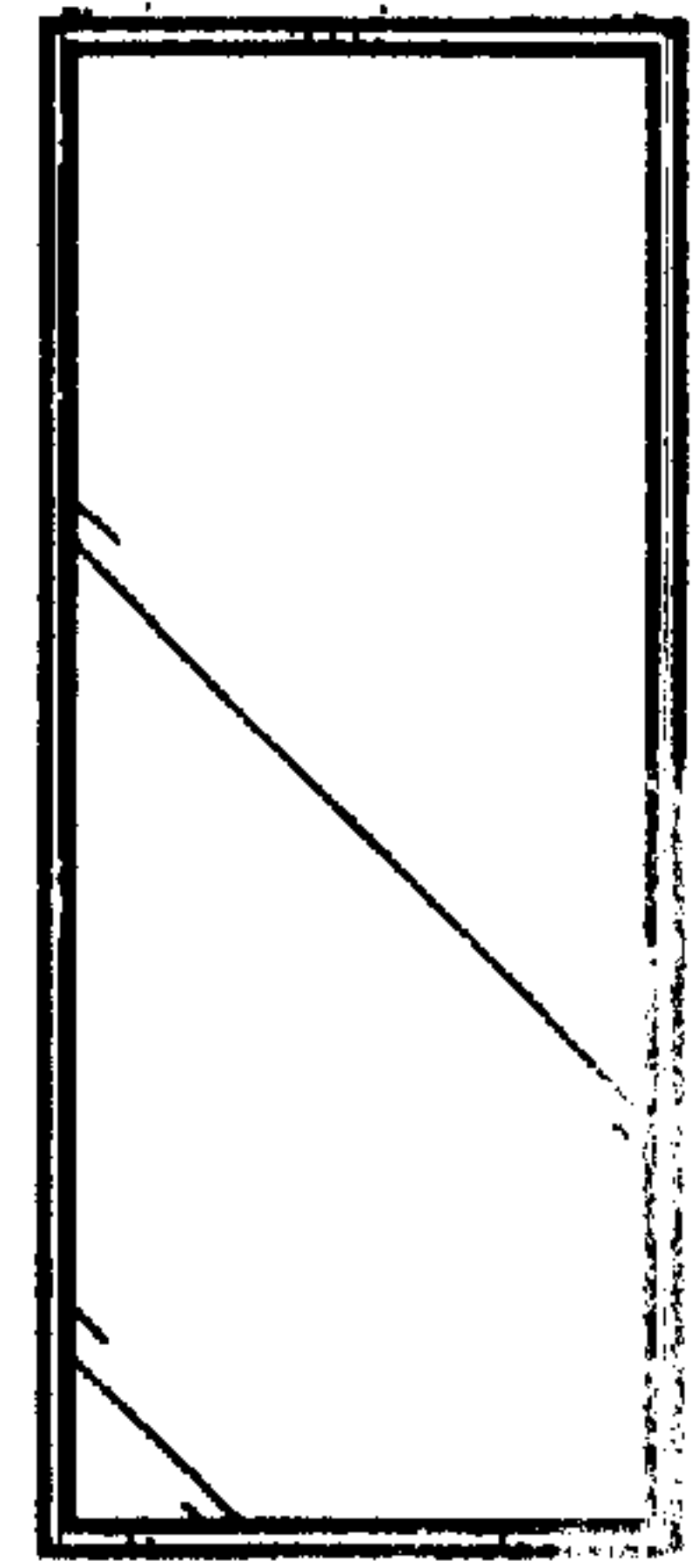

FIG.14

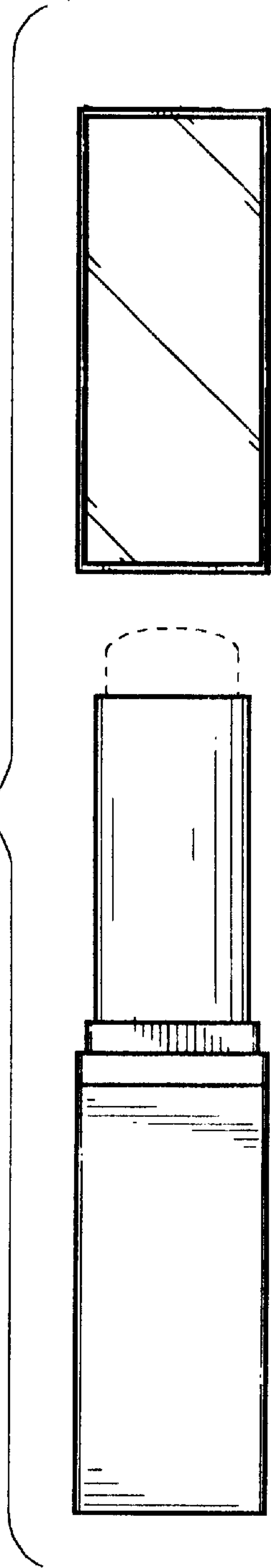

FIG.15

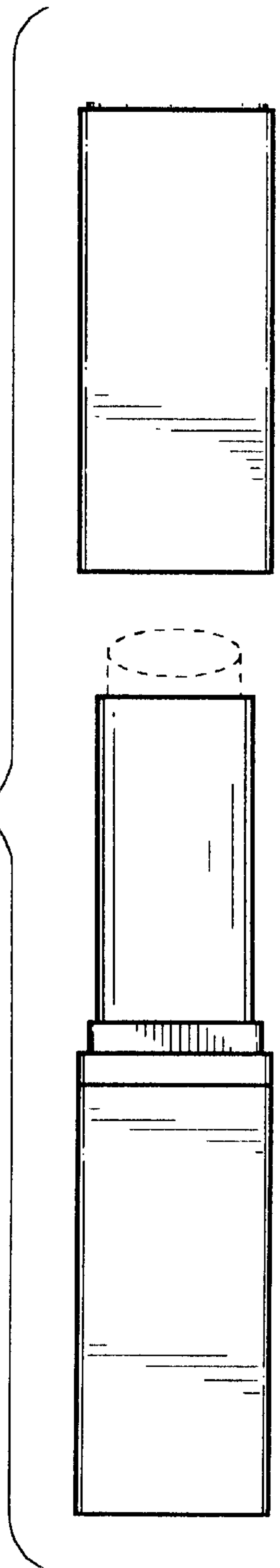

FIG.16

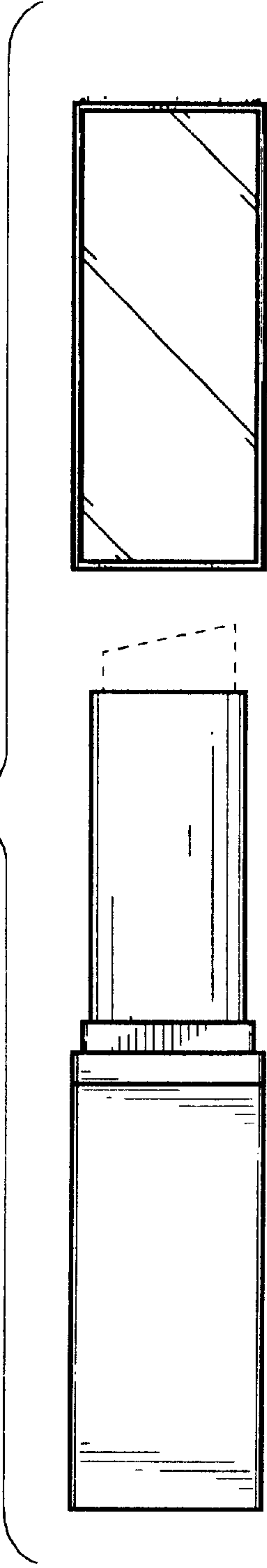

FIG.17

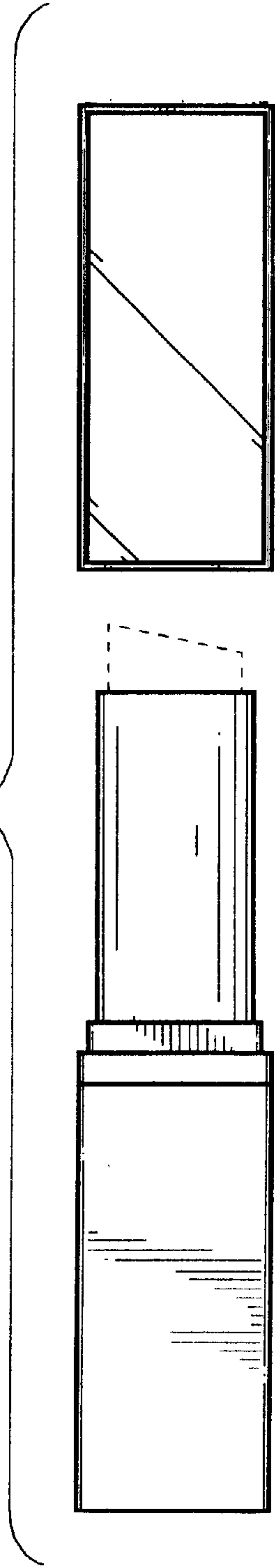

FIG.18

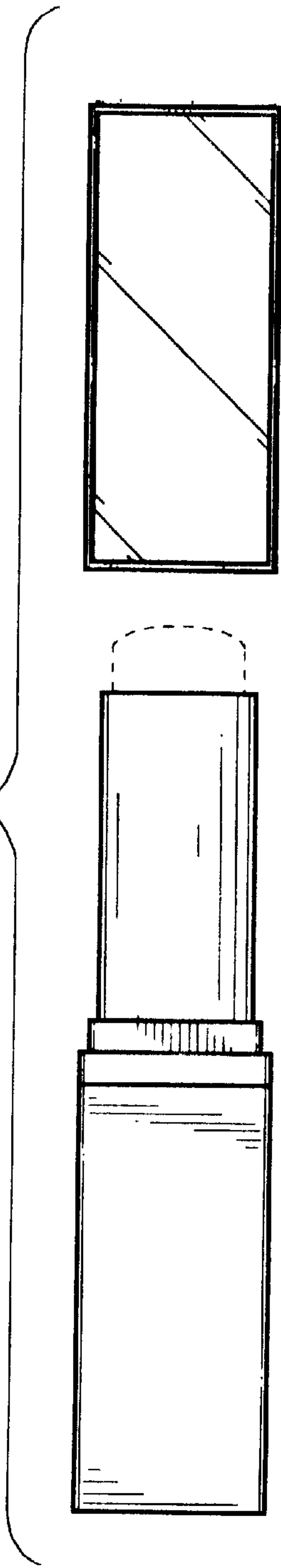

FIG.19

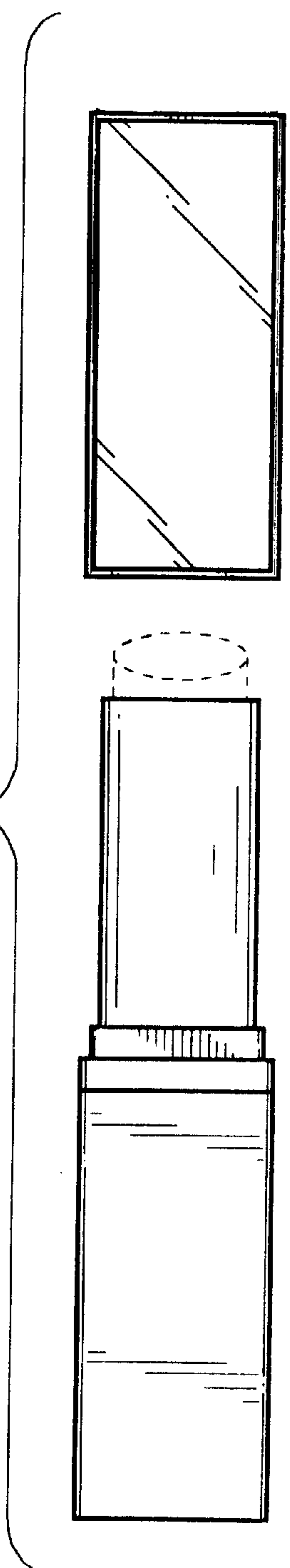

FIG.20

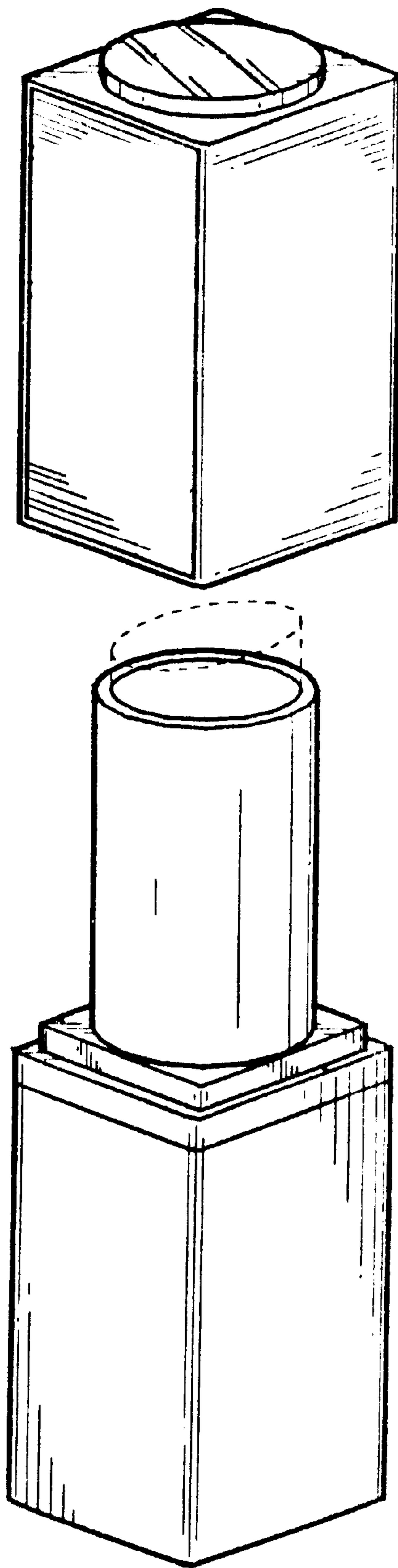

FIG.21

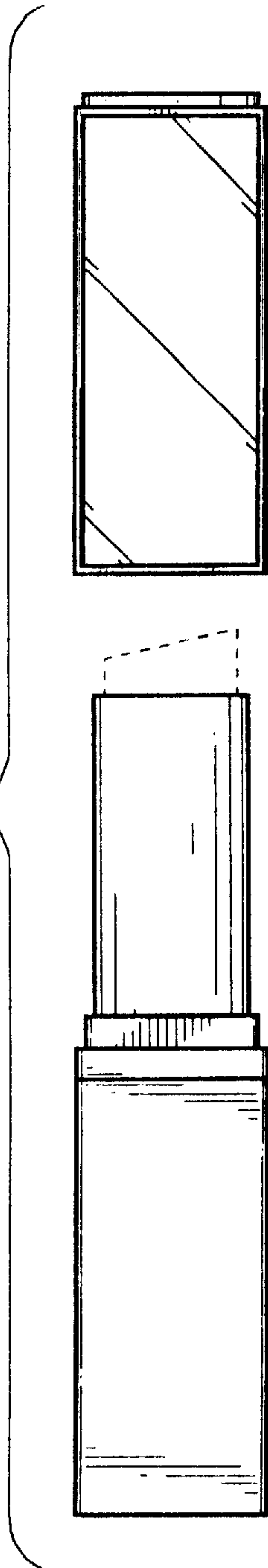

FIG.22

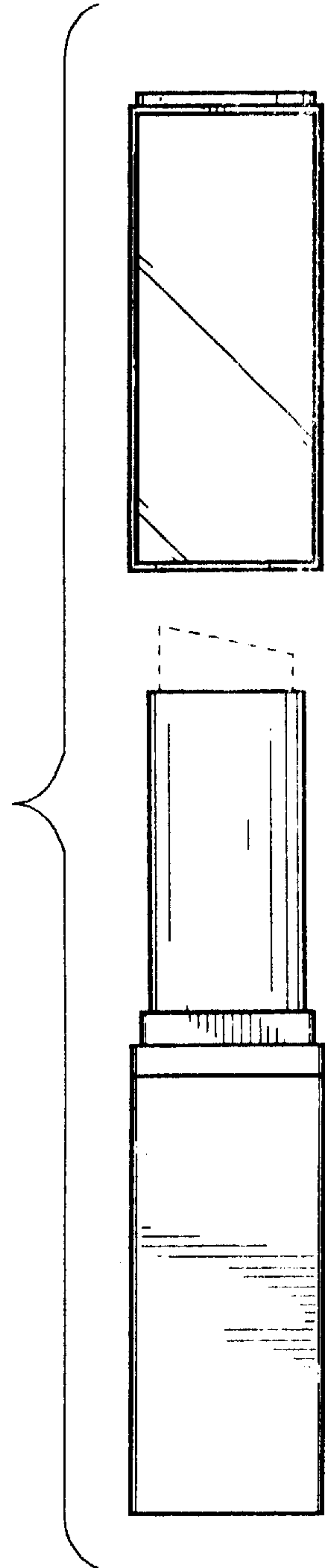

FIG.23

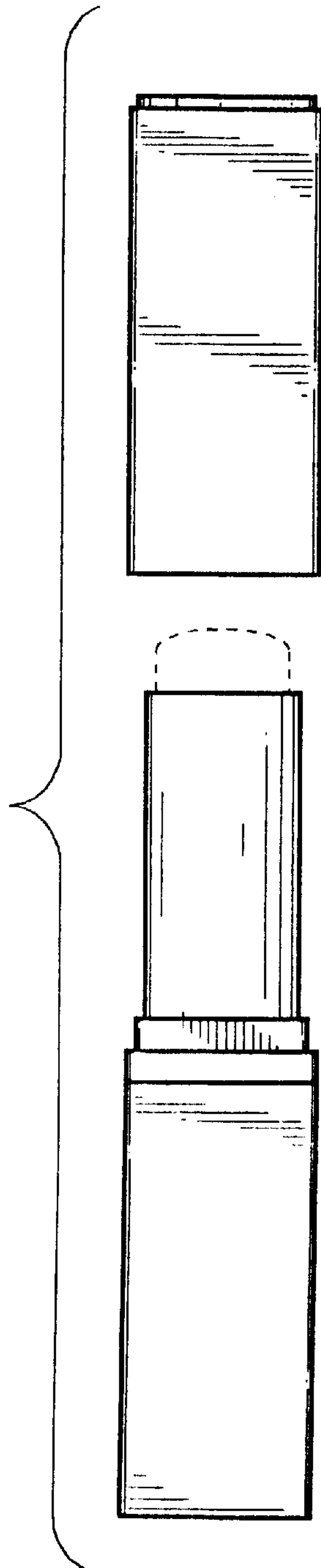
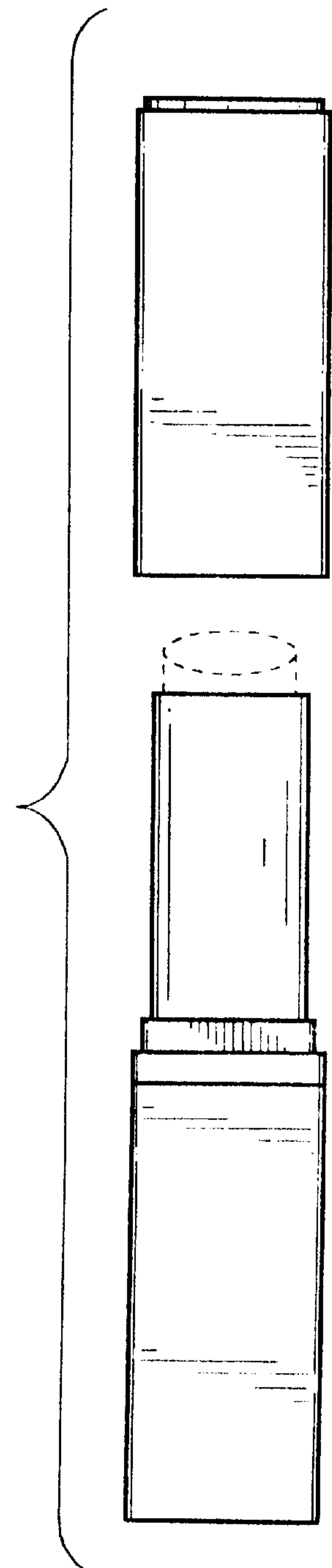

FIG.24



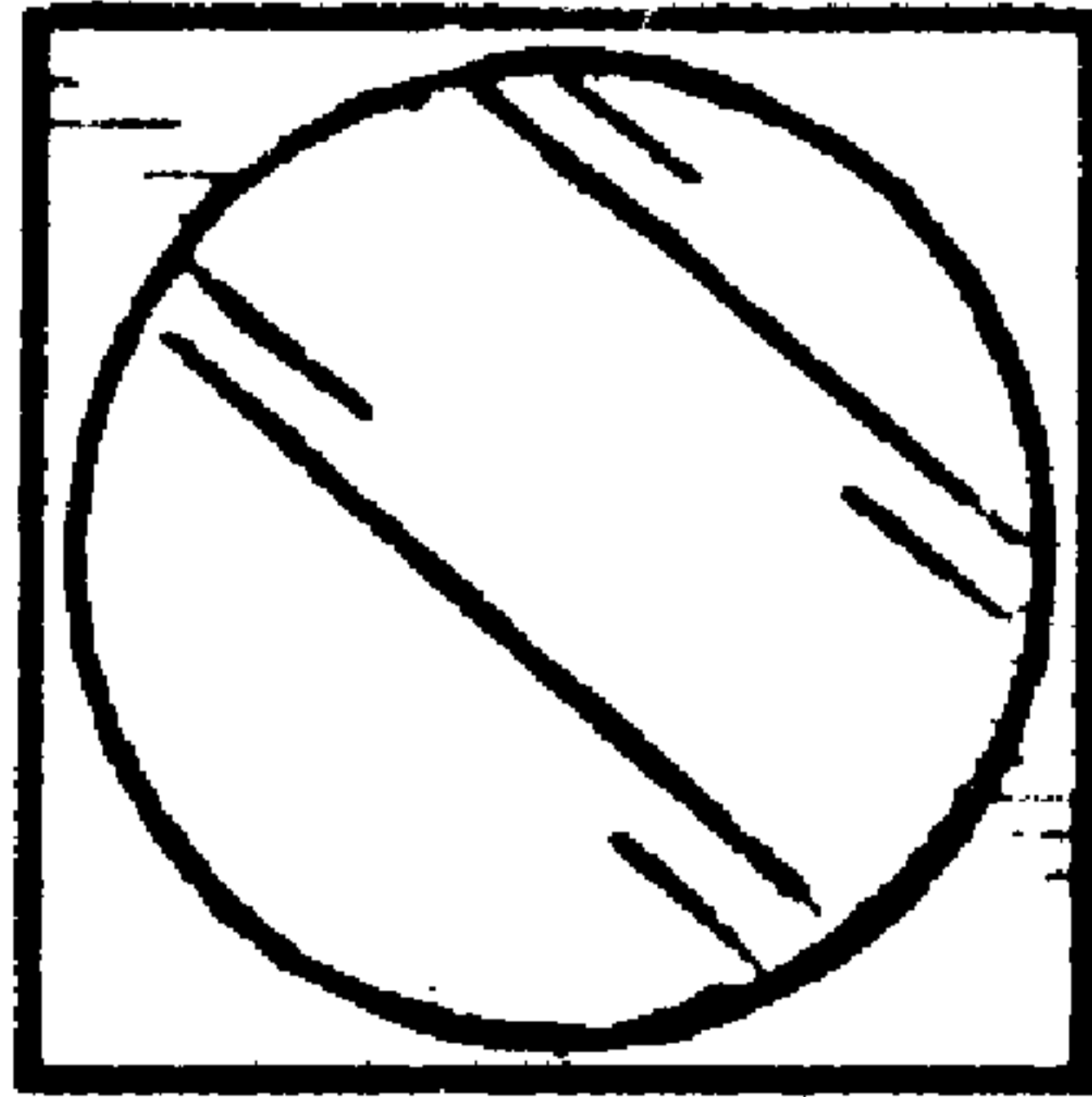

FIG. 25

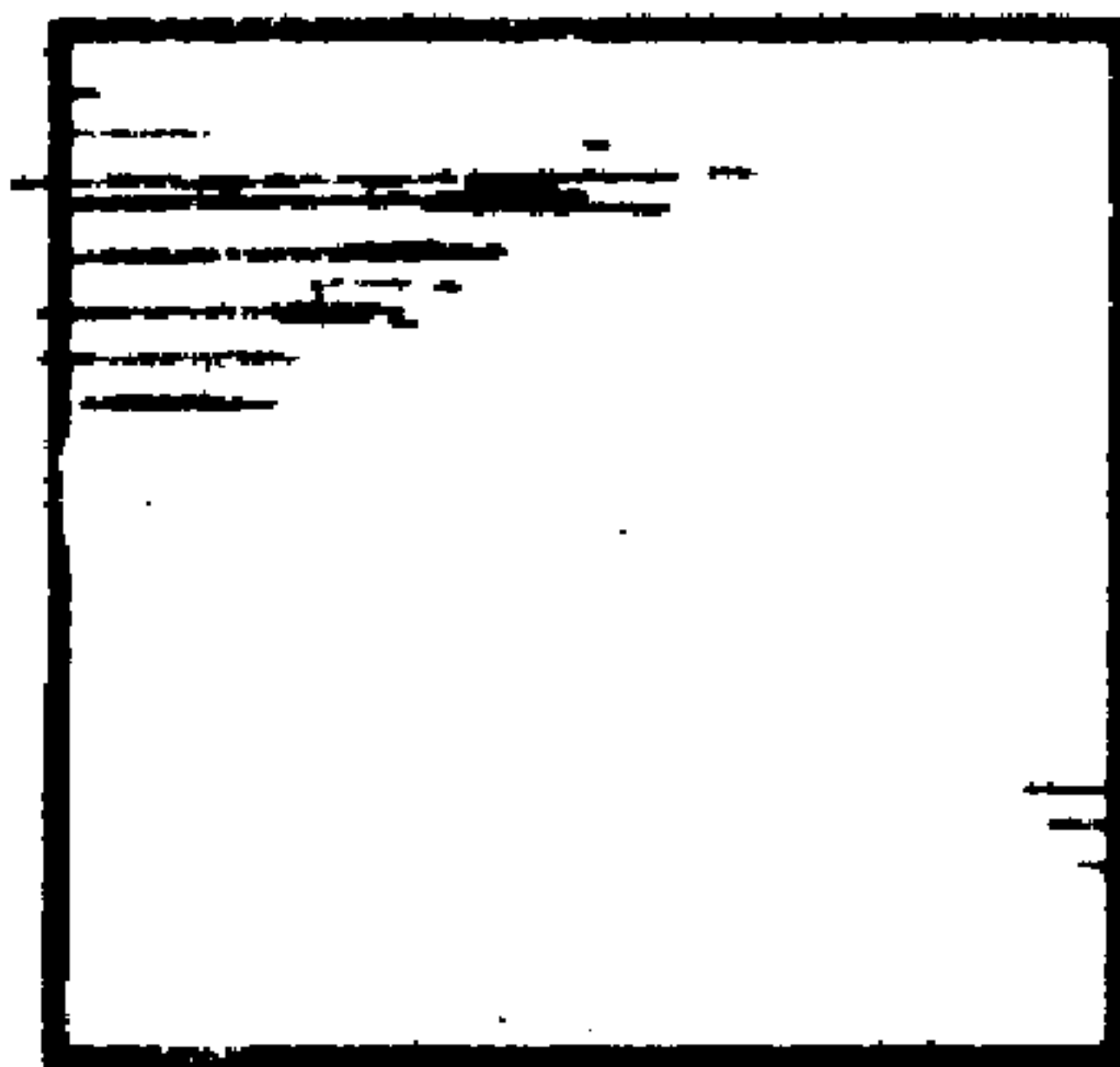

FIG. 26

FIG.27

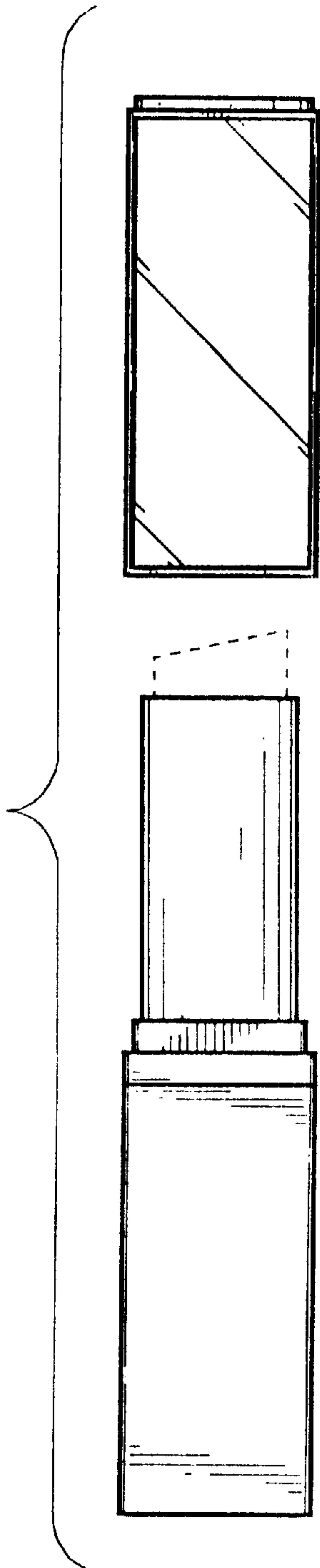

FIG.28

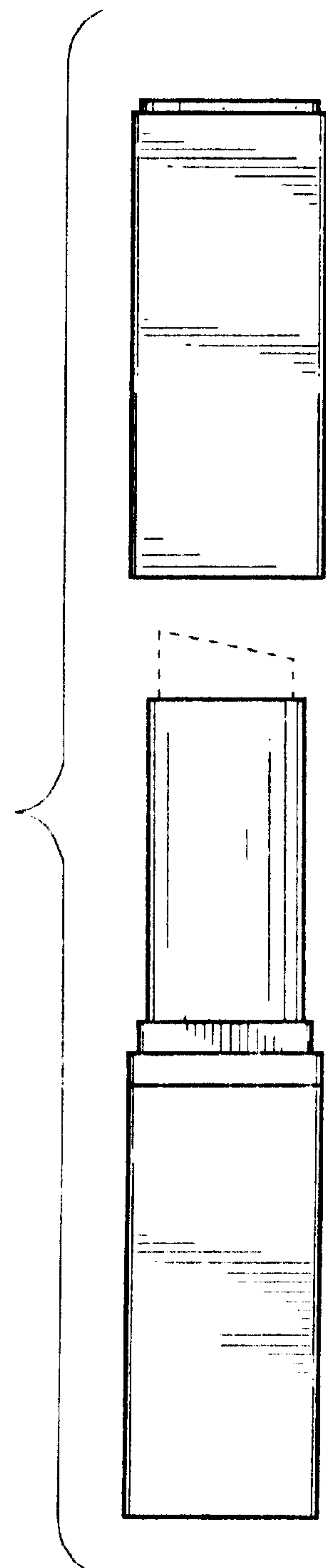

FIG.29

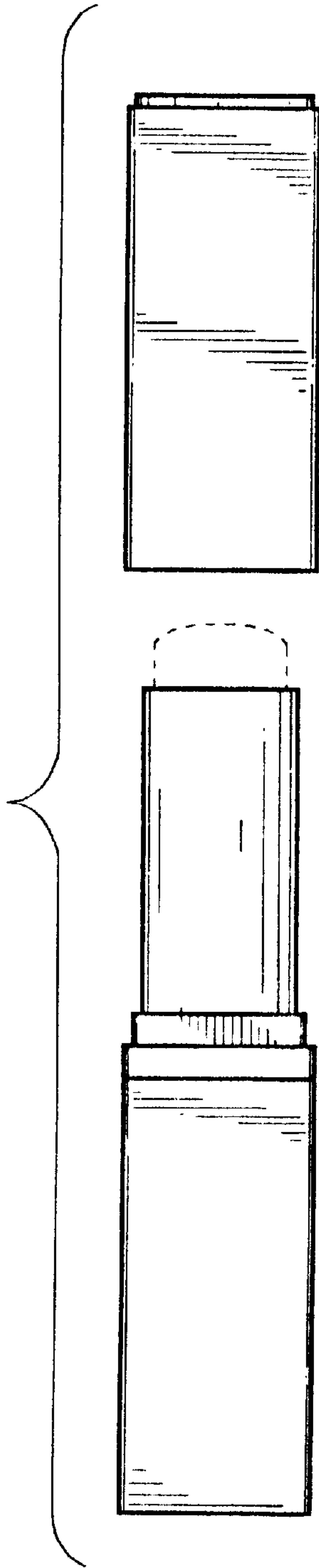

FIG.30

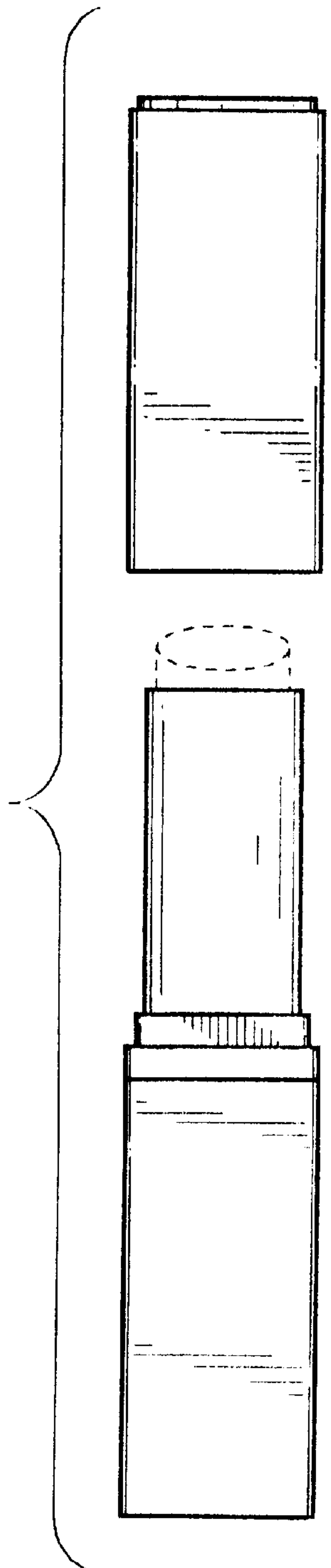

FIG.31

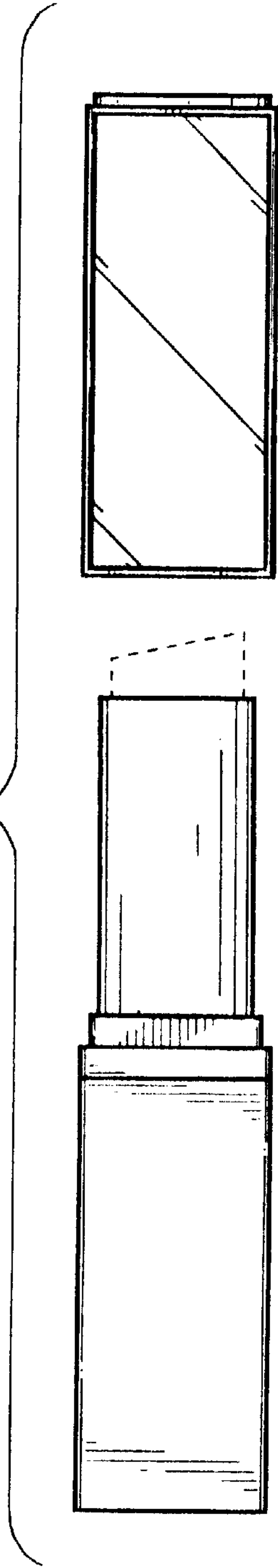

FIG.32

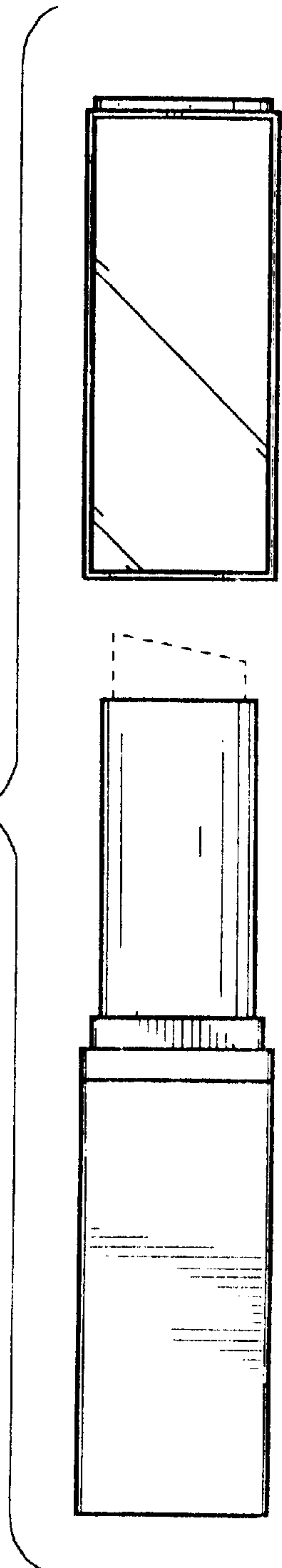

FIG.33

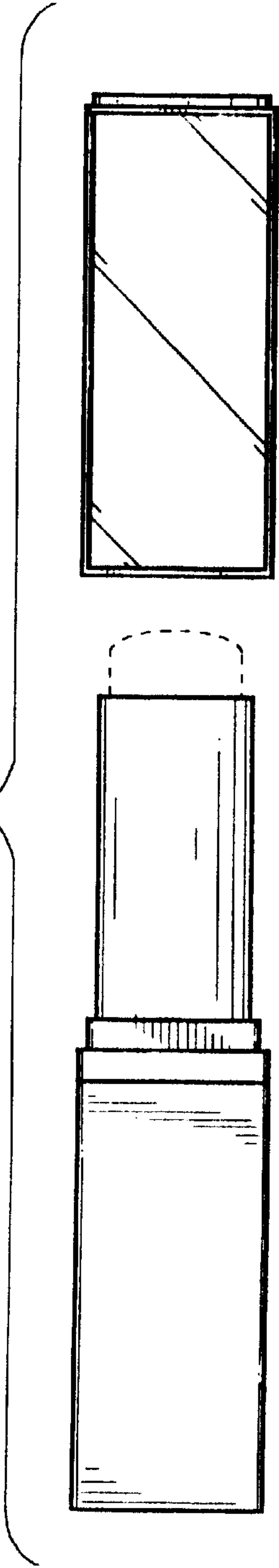

FIG.34

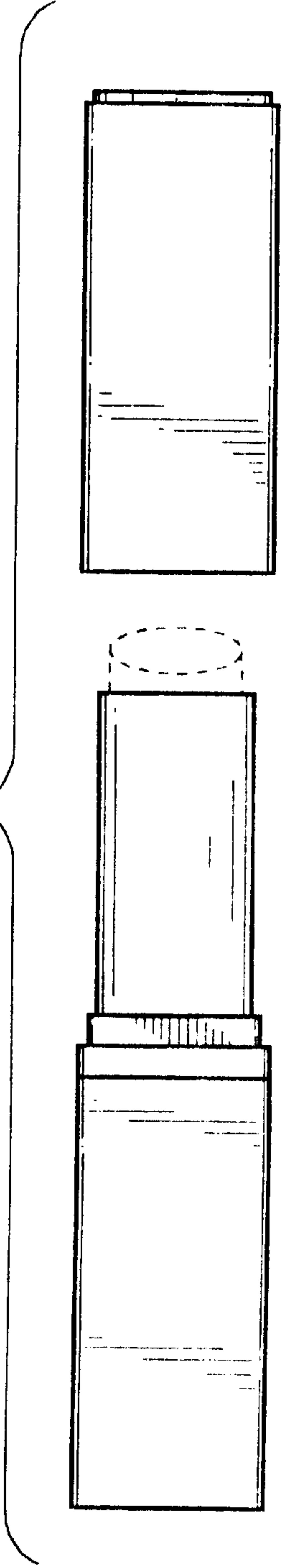

FIG. 35

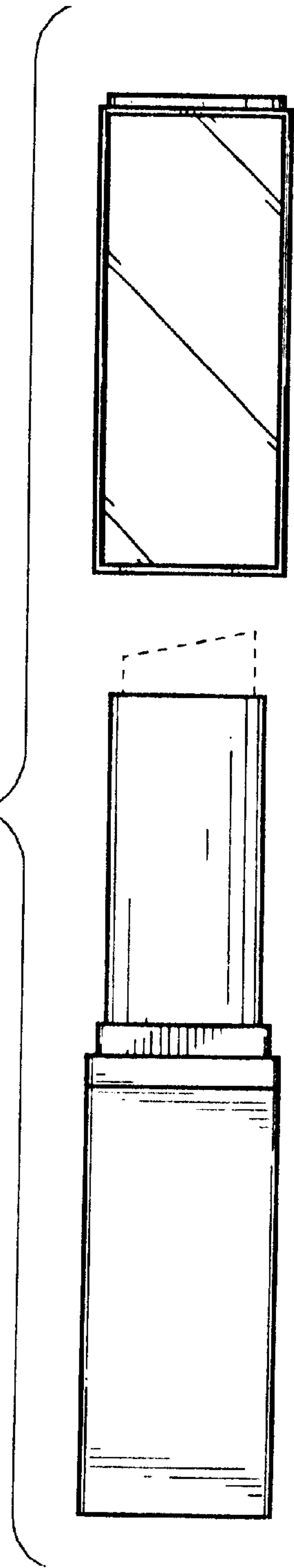

FIG. 36

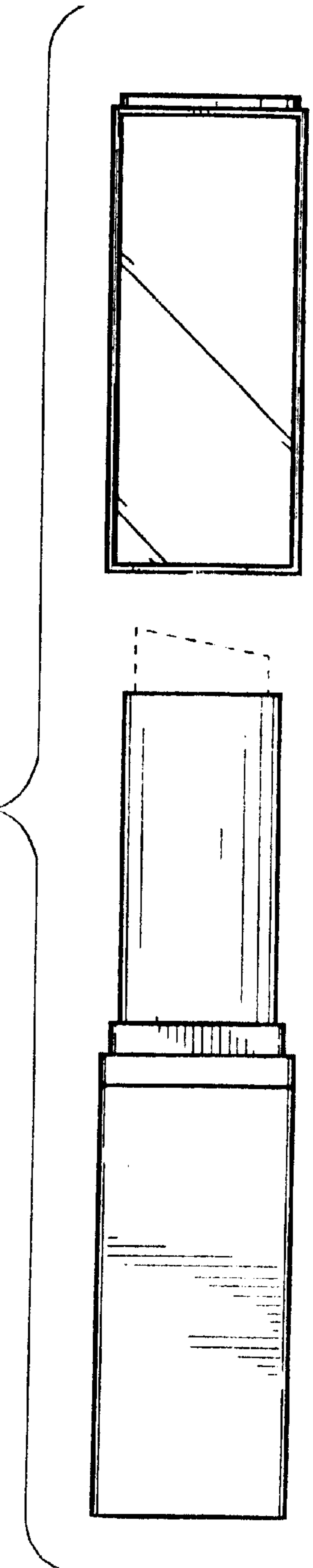

FIG.37

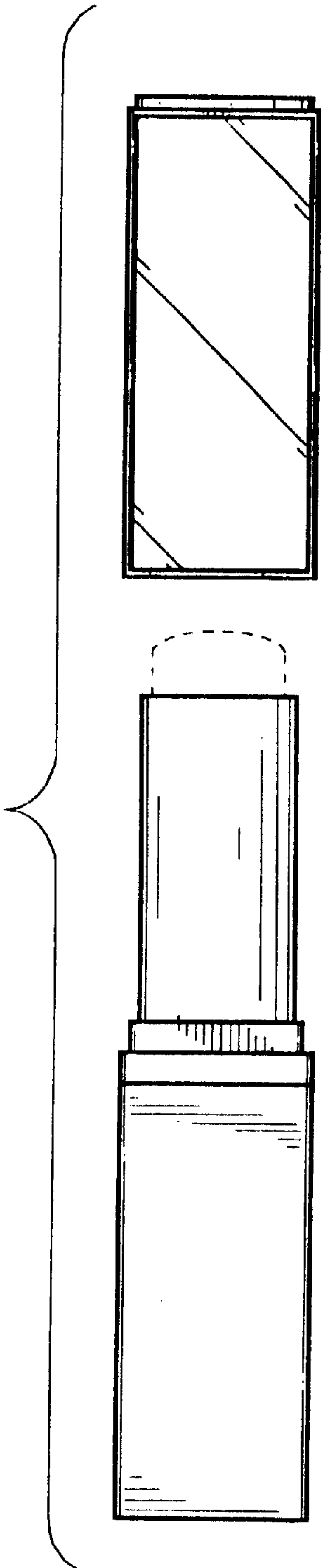

FIG.38

