



US00D471323S

(12) **United States Design Patent**
Lai

(10) **Patent No.:** **US D471,323 S**

(45) **Date of Patent:** **** Mar. 4, 2003**

(54) **COSMETIC CASING**

D452,938 S * 1/2002 Lai D28/77
D452,939 S * 1/2002 Lai D28/77

(75) Inventor: **Chin Chun Lai**, Chung Ho (TW)

OTHER PUBLICATIONS

(73) Assignee: **Chao Ling Chemical Industry Co., Ltd.**, Taipei Hsien (TW)

Hong Kong Enterprise Jun. 1994, p. 659: item No. 9324B.*

(**) Term: **14 Years**

* cited by examiner

(21) Appl. No.: **29/164,289**

Primary Examiner—Ted Shooman

Assistant Examiner—C. Tuttle

(22) Filed: **Jul. 19, 2002**

(57) **CLAIM**

(51) **LOC (7) Cl.** **28-02**

The ornamental design for a cosmetic casing, as shown and described.

(52) **U.S. Cl.** **D28/83**

(58) **Field of Search** D28/76-84; D9/341, D9/423, 420, 418; D3/273-275, 294-295, 901; 132/286-318; 206/235, 581, 823, 1.7, 1.8, 1.9, 81; 220/DIG. 26

DESCRIPTION

(56) **References Cited**

U.S. PATENT DOCUMENTS

- D153,509 S * 4/1949 Flato D28/81
- 5,078,159 A * 1/1992 Yuhara 132/295
- 5,161,556 A * 11/1992 Audebourg et al. 132/296
- D407,856 S * 4/1999 Orsomando D28/83
- D443,393 S * 6/2001 Goswell D28/83

FIG. 1 is a perspective view of a cosmetic casing showing my new design;
 FIG. 2 is a front elevational view thereof;
 FIG. 3 is a rear elevational view thereof;
 FIG. 4 is a top plan view thereof;
 FIG. 5 is a bottom plan view thereof;
 FIG. 6 is a left side elevational view thereof; and,
 FIG. 7 is a right side elevational view thereof.

1 Claim, 3 Drawing Sheets

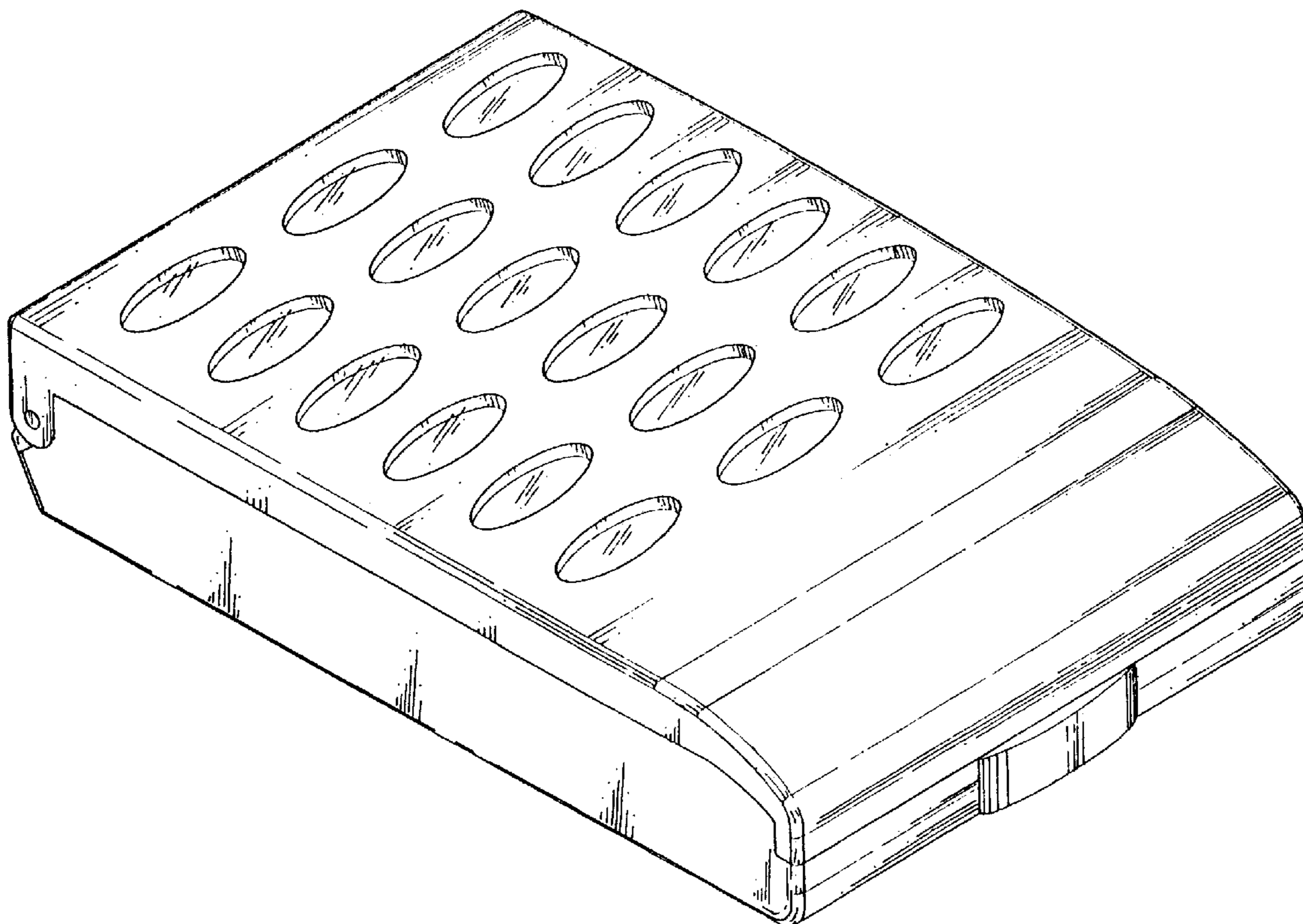

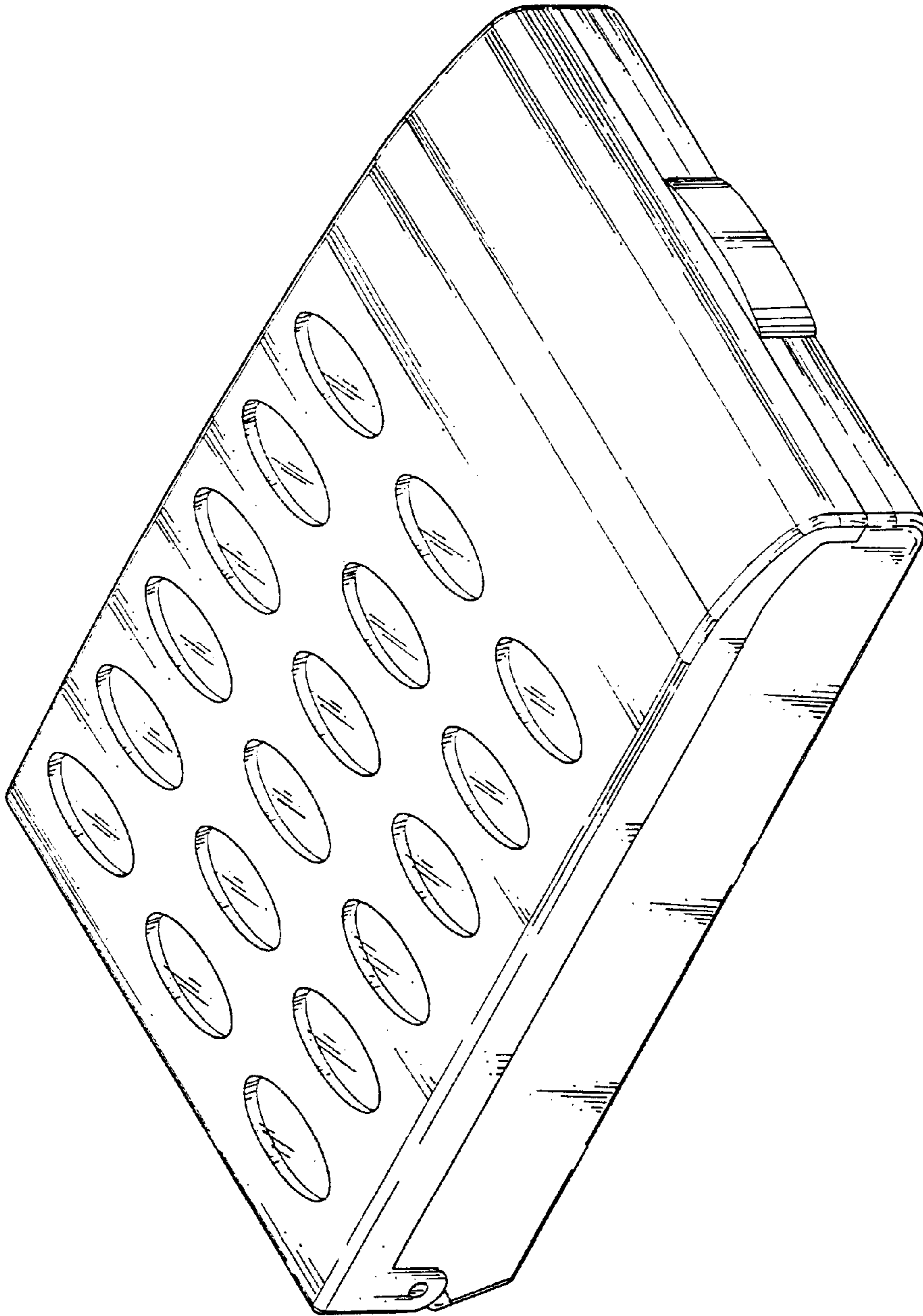

FIG. 1

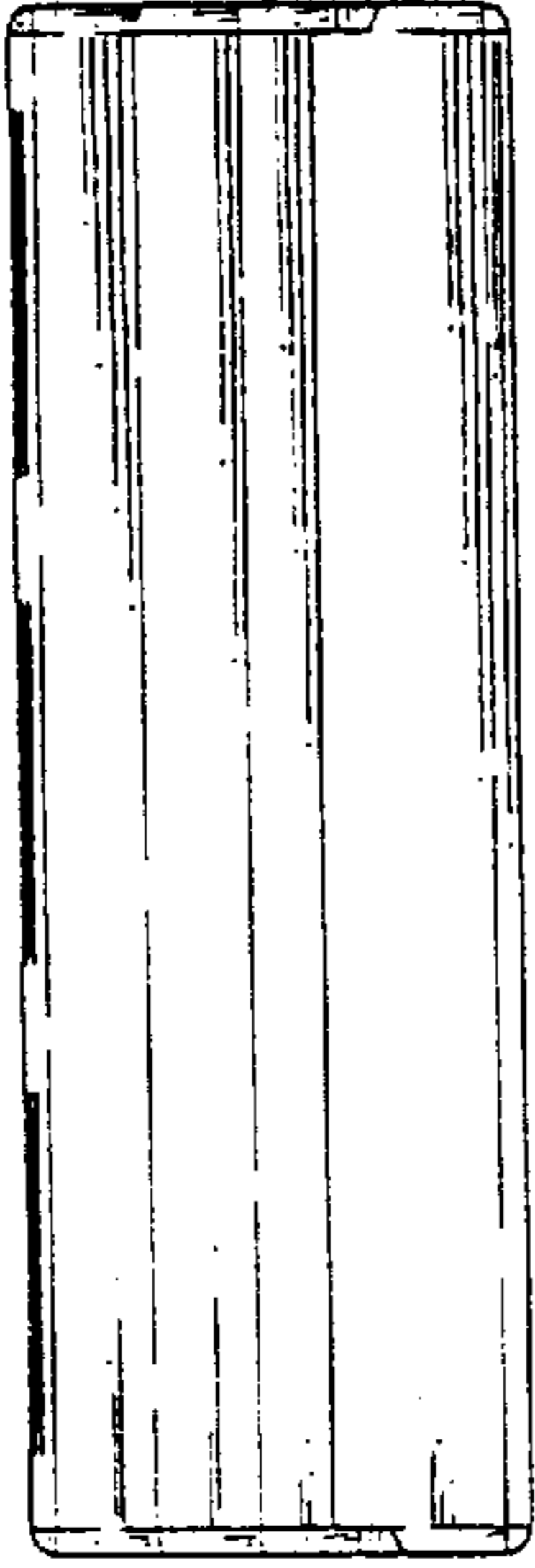

FIG. 3

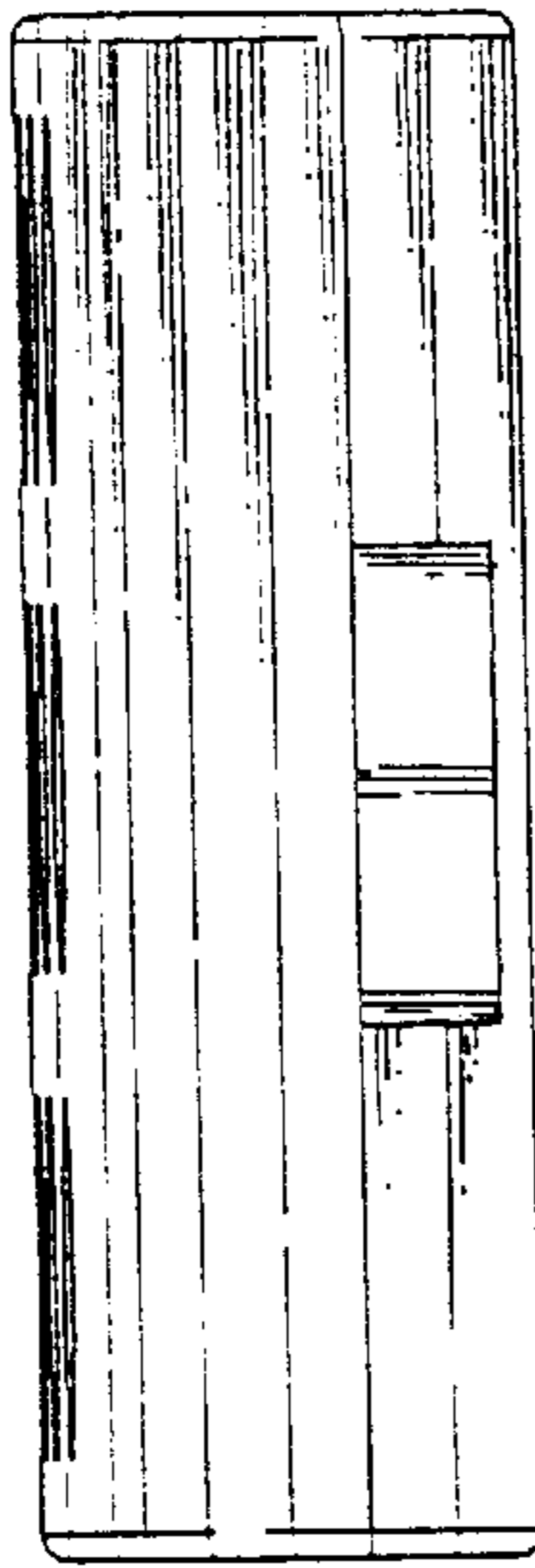

FIG. 2

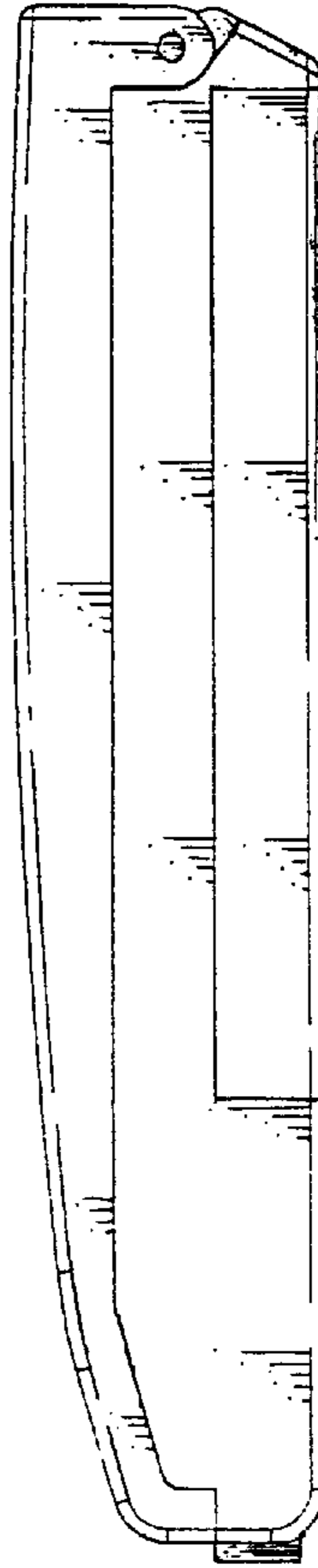

FIG. 7

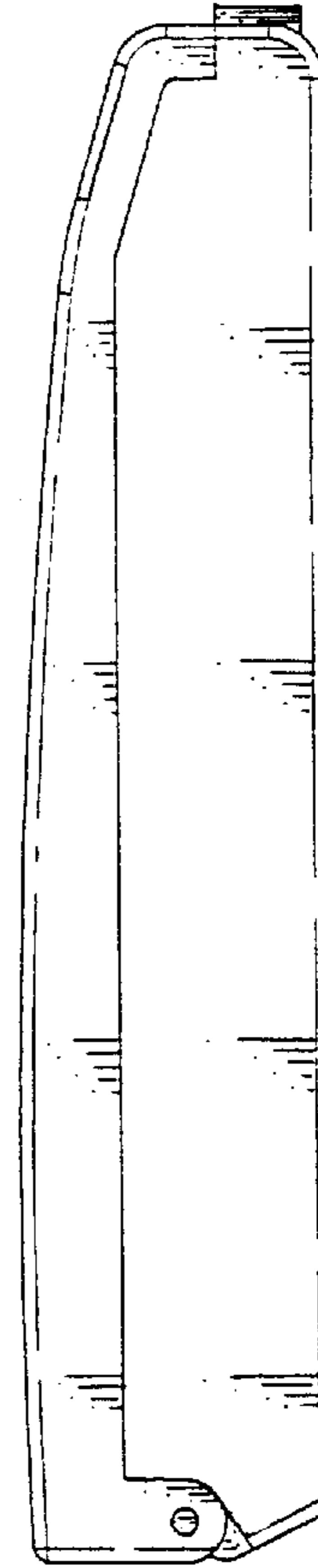

FIG. 6

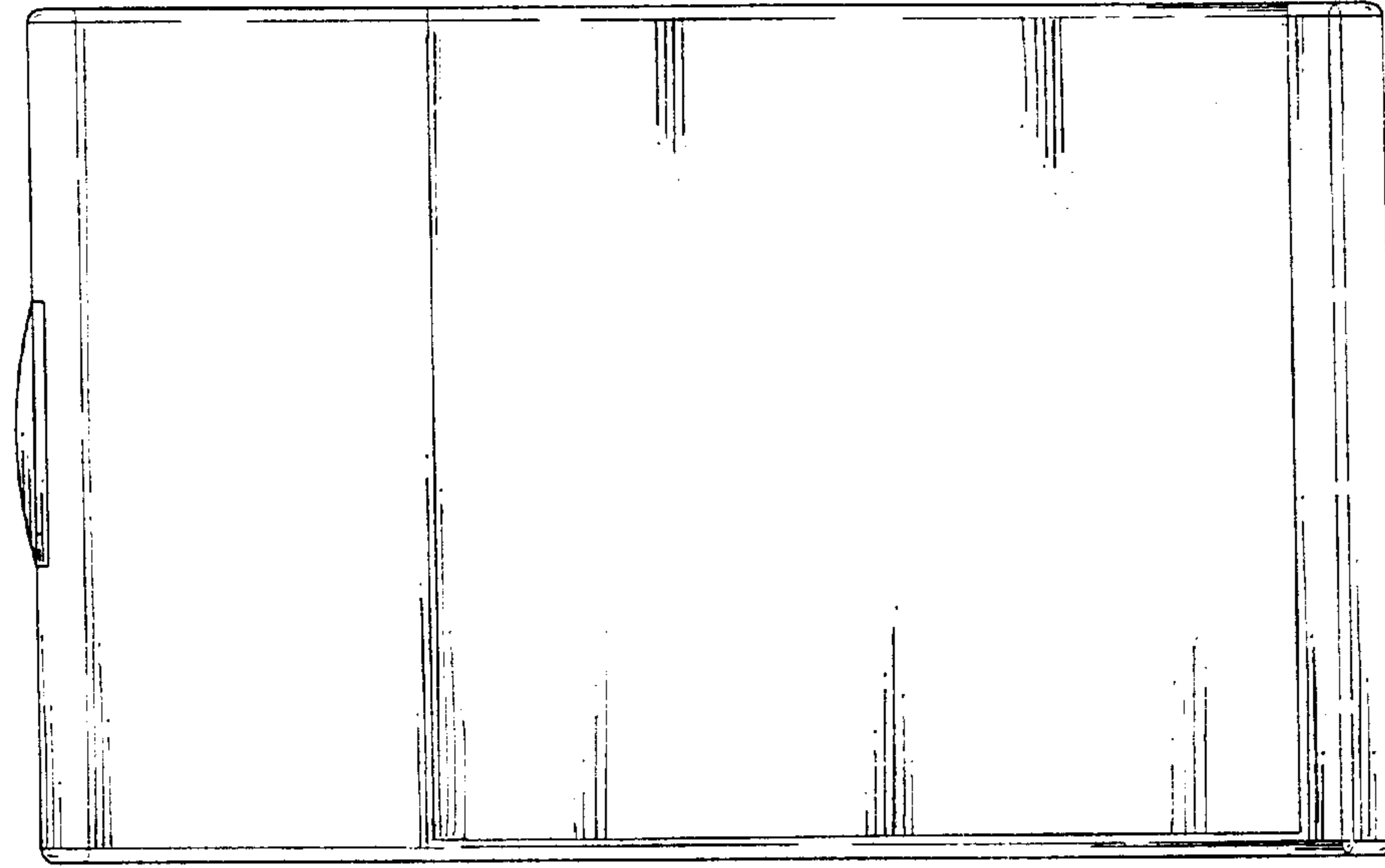

FIG. 5

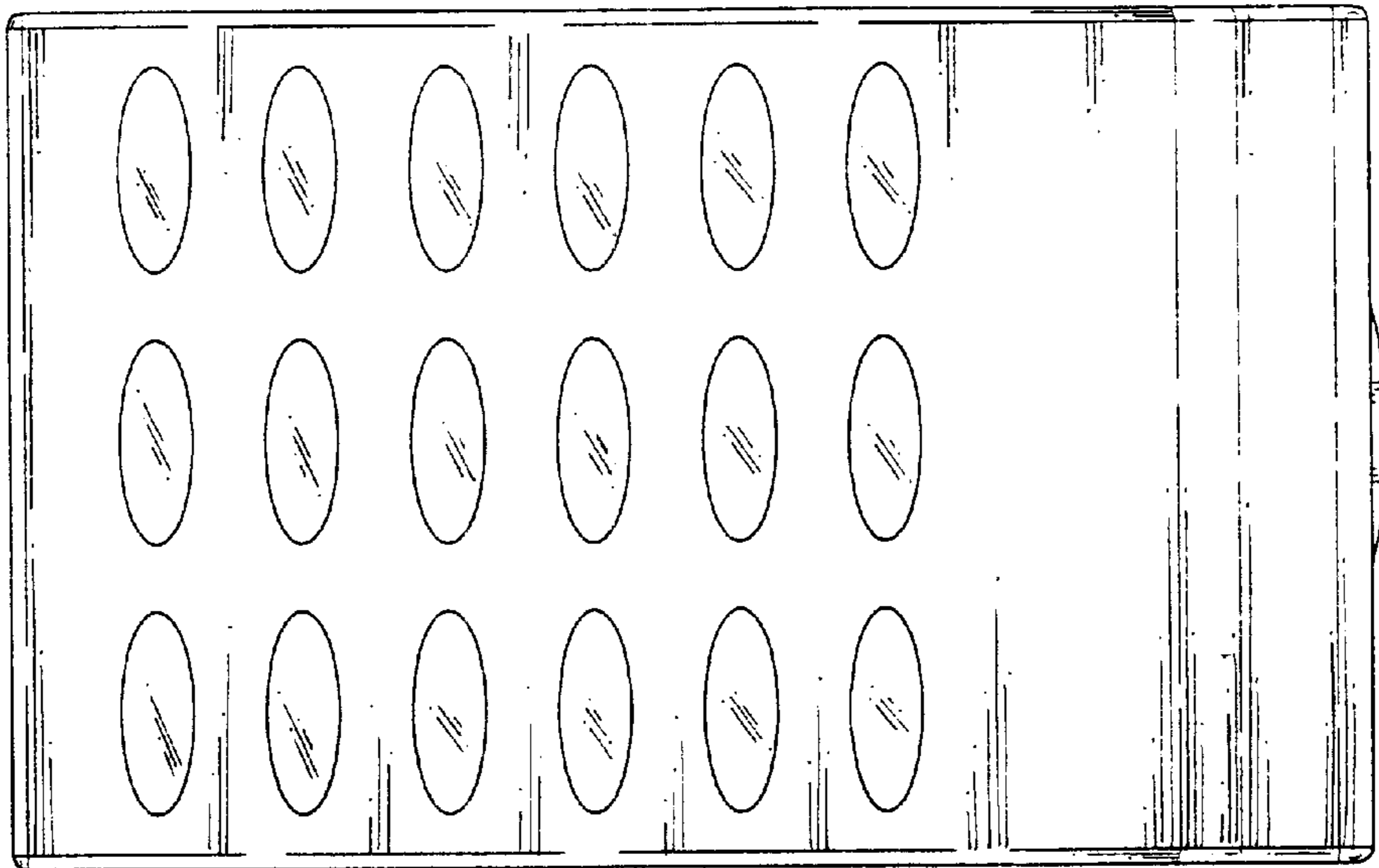

FIG. 4