



US00D471210S

(12) **United States Design Patent**
Tsunoda

(10) **Patent No.:** **US D471,210 S**

(45) **Date of Patent:** **** Mar. 4, 2003**

(54) **PISTON FOR REFRIGERANT COMPRESSORS**

D447,150 S 8/2001 Miyazawa et al.

* cited by examiner

(75) Inventor: **Masataka Tsunoda**, Isesaki (JP)

Primary Examiner—Ralf Seifert

(73) Assignee: **Sanden Corporation**, Gunma (JP)

(74) *Attorney, Agent, or Firm*—Baker Botts L.L.P.

(**) Term: **14 Years**

(57) **CLAIM**

(21) Appl. No.: **29/152,372**

The ornamental design for pistons for refrigerant compressors, as shown.

(22) Filed: **Dec. 20, 2001**

DESCRIPTION

Related U.S. Application Data

(62) Division of application No. 29/129,342, filed on Sep. 14, 2000, now Pat. No. Des. 454888.

FIG. 1 is a front elevational view of a piston for refrigerant compressors showing my new design;

(51) **LOC (7) Cl.** **15-02**

FIG. 2 is a rear elevational view;

(52) **U.S. Cl.** **D15/9**

FIG. 3 is a left side elevational view;

(58) **Field of Search** D15/5-9; 417/545, 417/222.1, 266, 273, 269; 91/505; 92/71, 12.2, 165 R; 74/60

FIG. 4 is a top plan view;

FIG. 5 is a bottom plan view;

FIG. 6 is a cross-sectional view taken along the line 6—6 of FIG. 1; and

FIG. 7 is a perspective view;

(56) **References Cited**

FIG. 8 is a front elevational view of a piston for refrigerant compressors showing a second embodiment of my new design;

U.S. PATENT DOCUMENTS

5,461,967 A	10/1995	Burkett et al.	
5,490,767 A	2/1996	Kanou et al.	
D371,562 S	* 7/1996	Rushfeldt D15/7
D402,295 S	12/1998	Kayukawa et al.	
D417,225 S	11/1999	Kimura et al.	
5,988,041 A	11/1999	Hiramatsu et al.	
D417,876 S	12/1999	Kayukawa et al.	
D436,113 S	1/2001	Kayukawa et al.	

FIG. 9 is a rear elevational view of FIG. 8;

FIG. 10 is a left side elevational view of FIG. 8;

FIG. 11 is a top plan view of FIG. 8;

FIG. 12 is a bottom plan view of FIG. 8;

FIG. 13 is a cross-sectional view taken along the line 13—13 of FIG. 8; and,

FIG. 14 is a perspective view of FIG. 8.

1 Claim, 8 Drawing Sheets

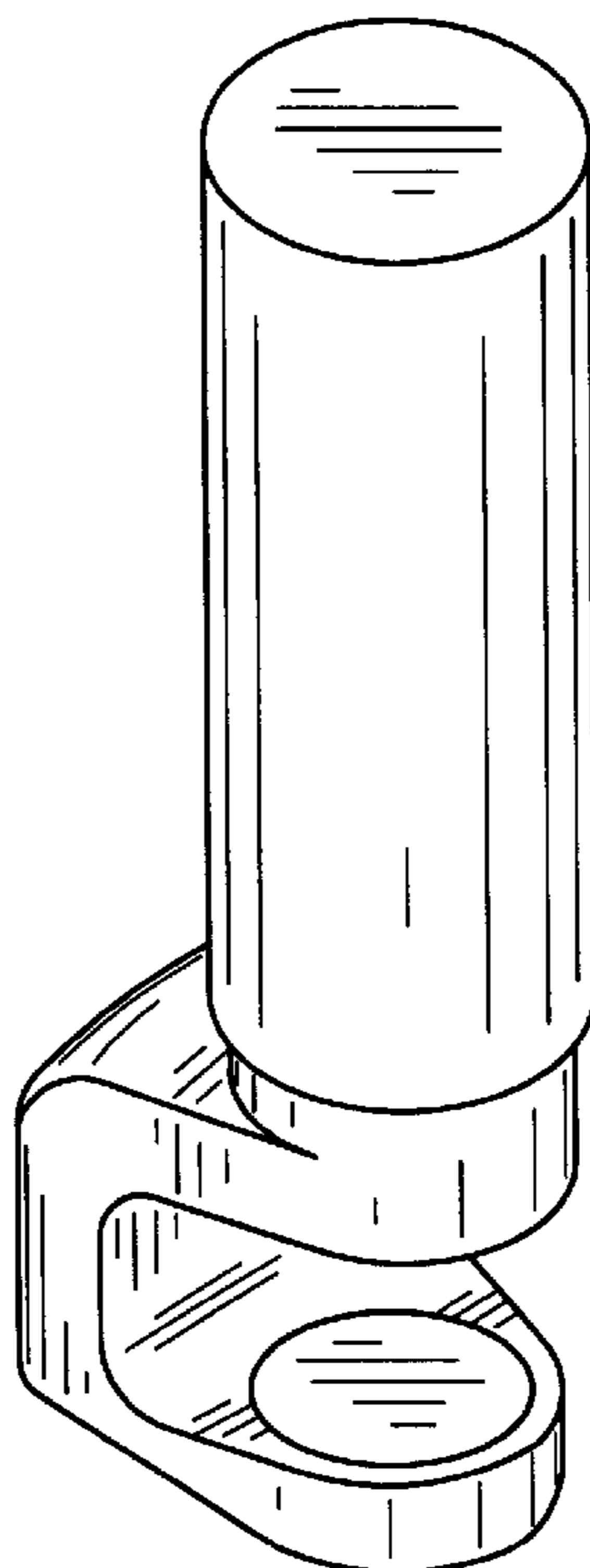

FIG. 1

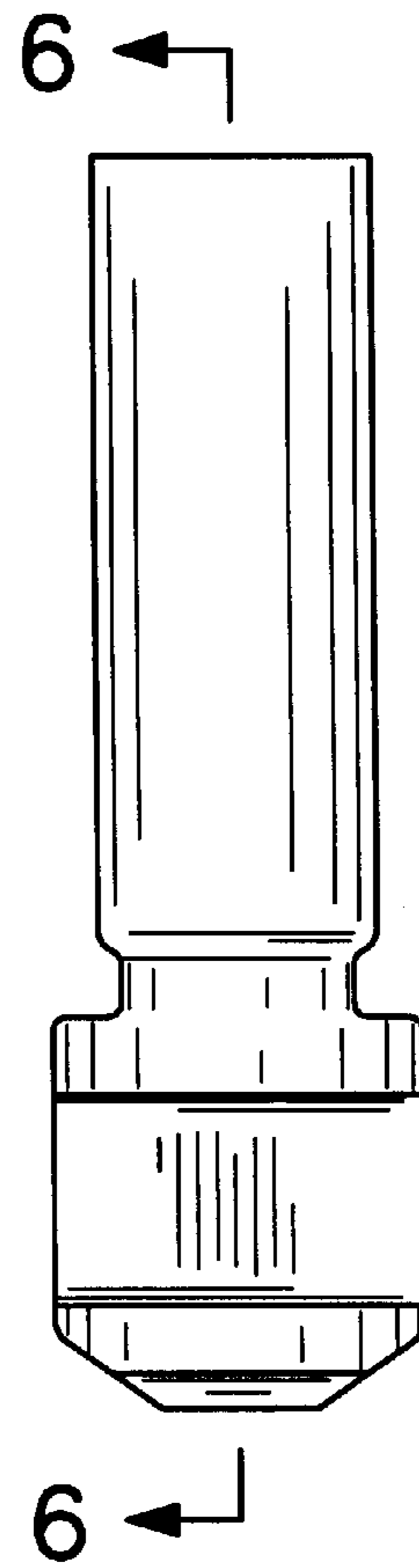

FIG. 2

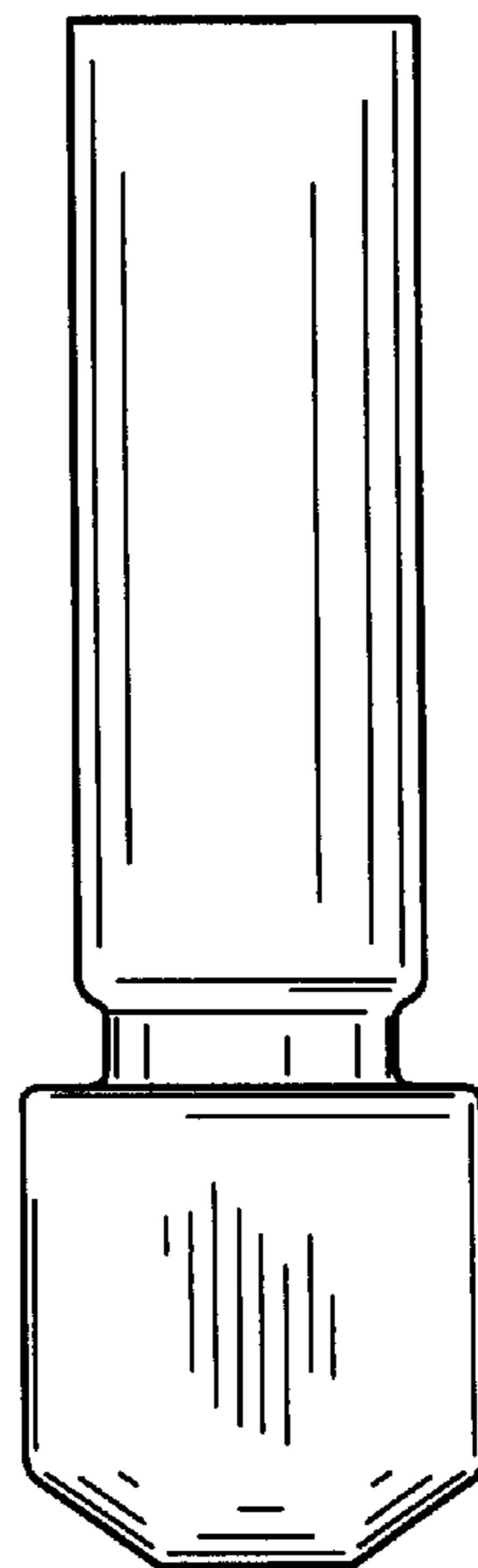

FIG. 3

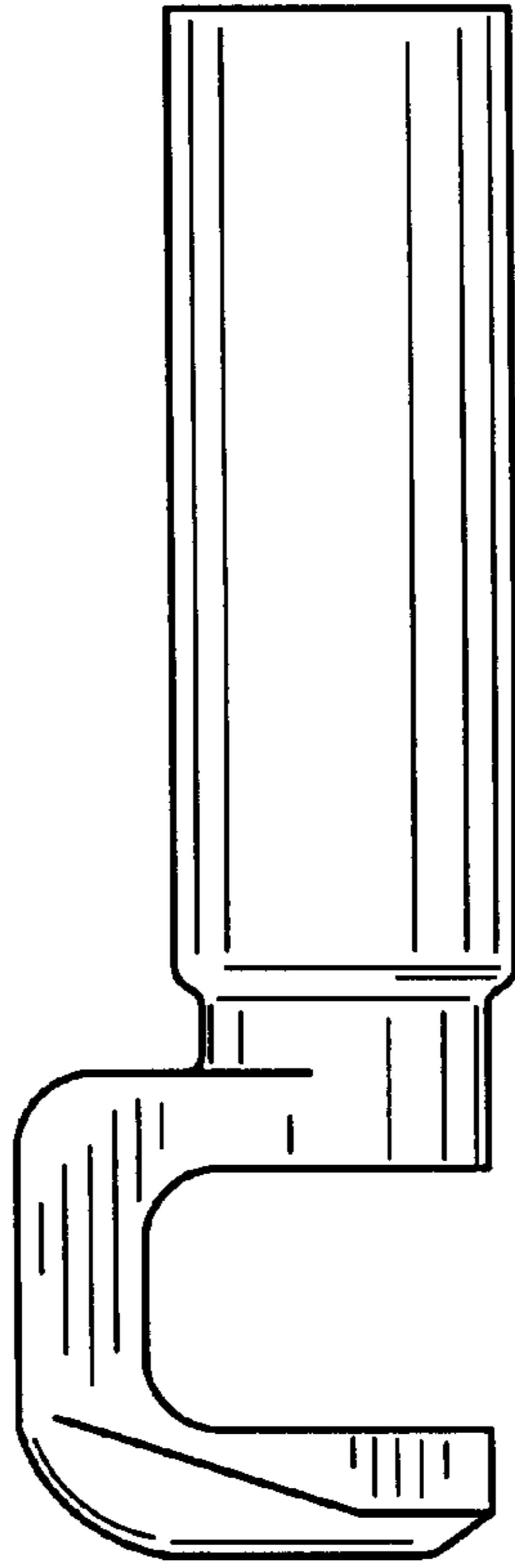

FIG. 4

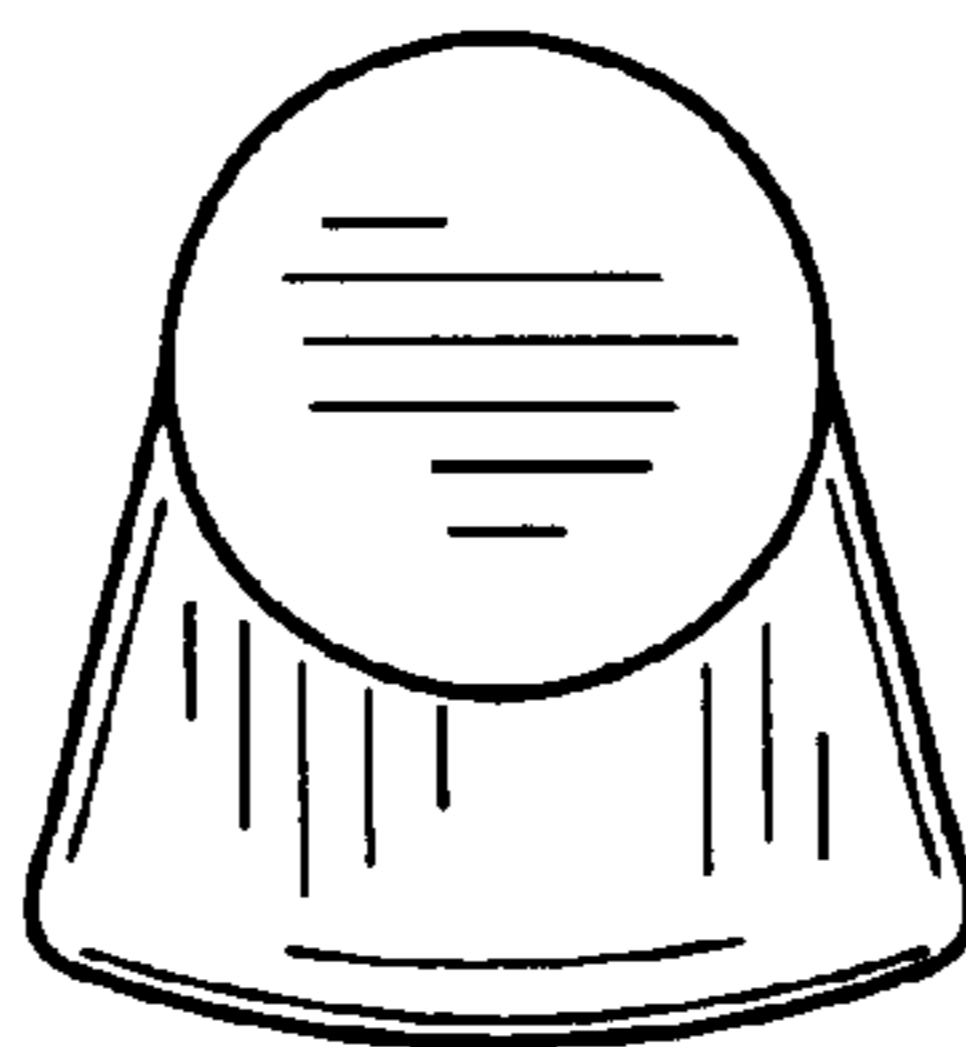

FIG. 5

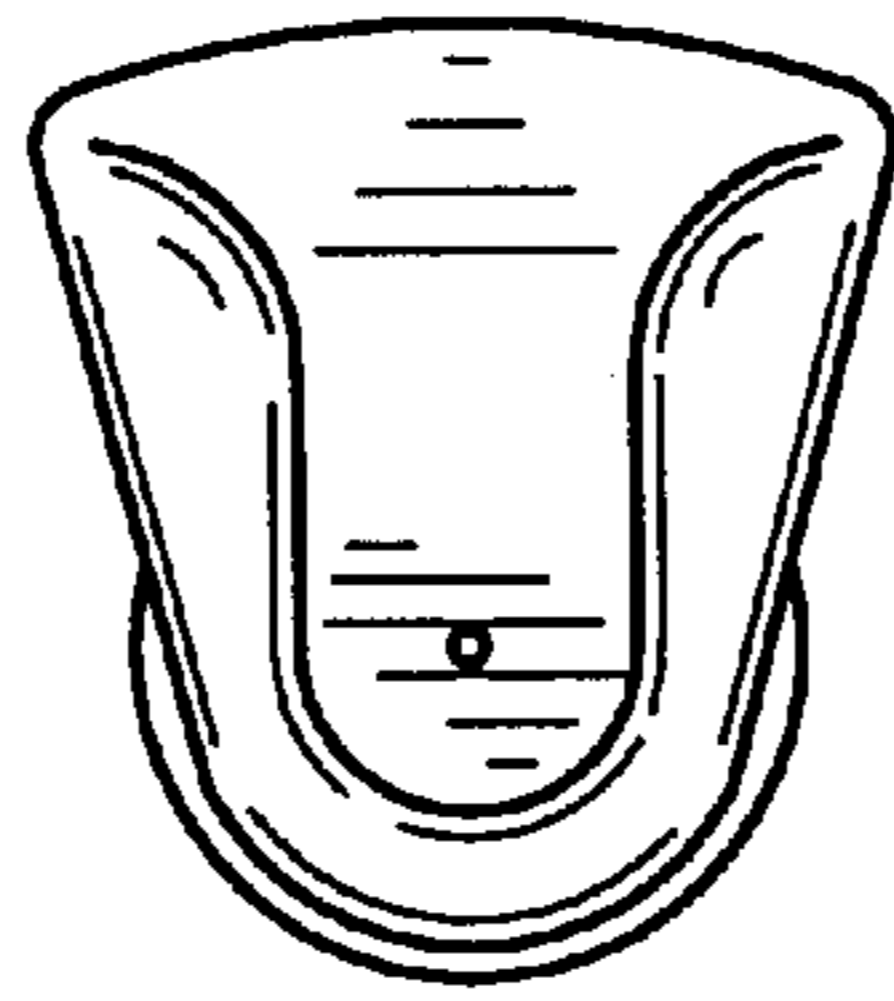

FIG. 6

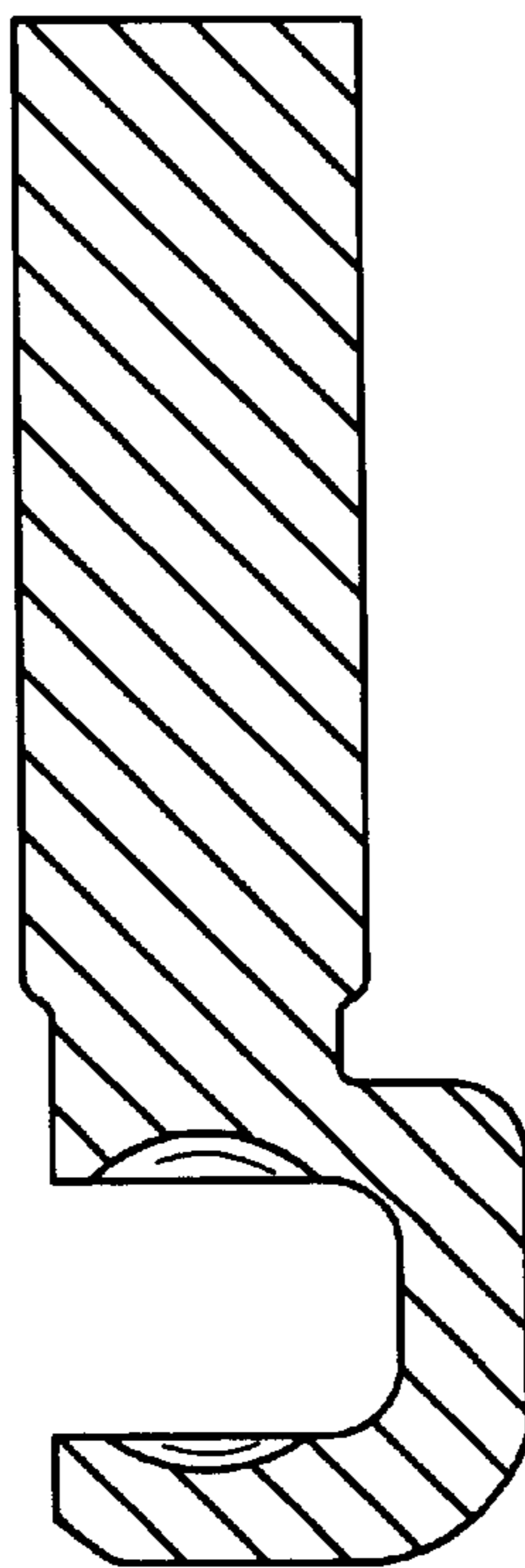

FIG. 7

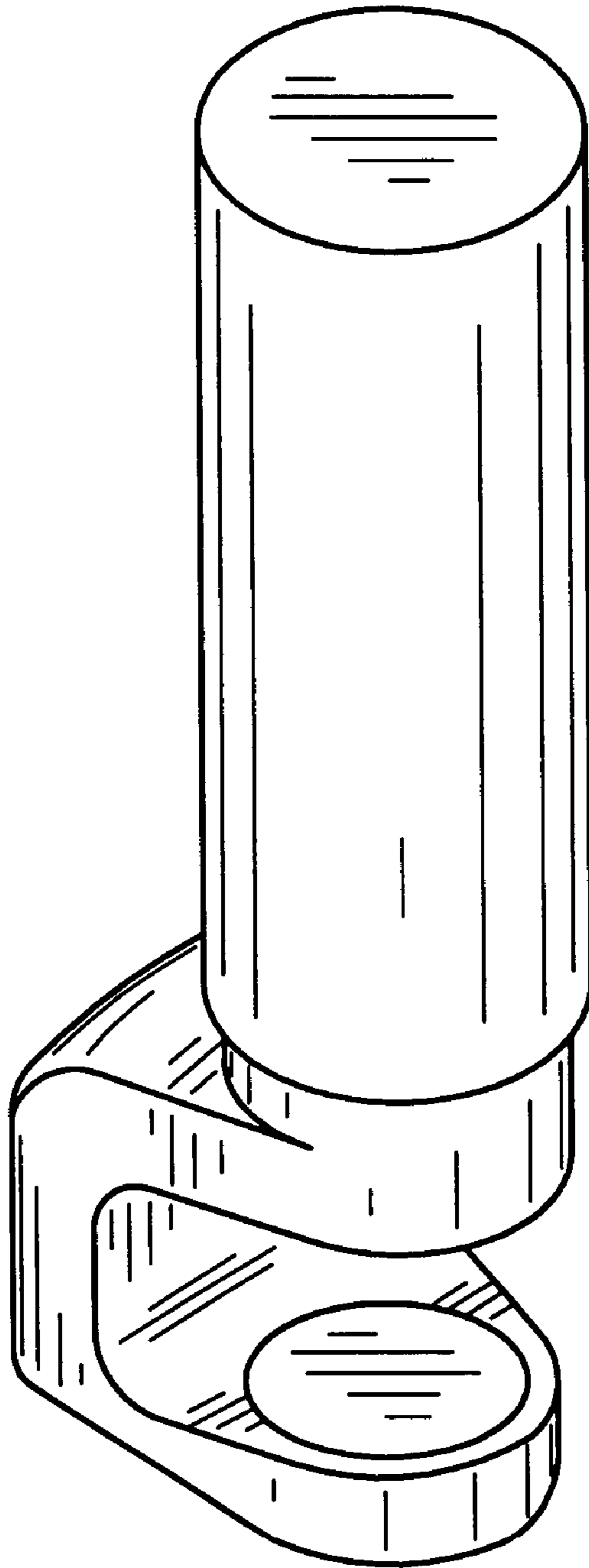

FIG. 8

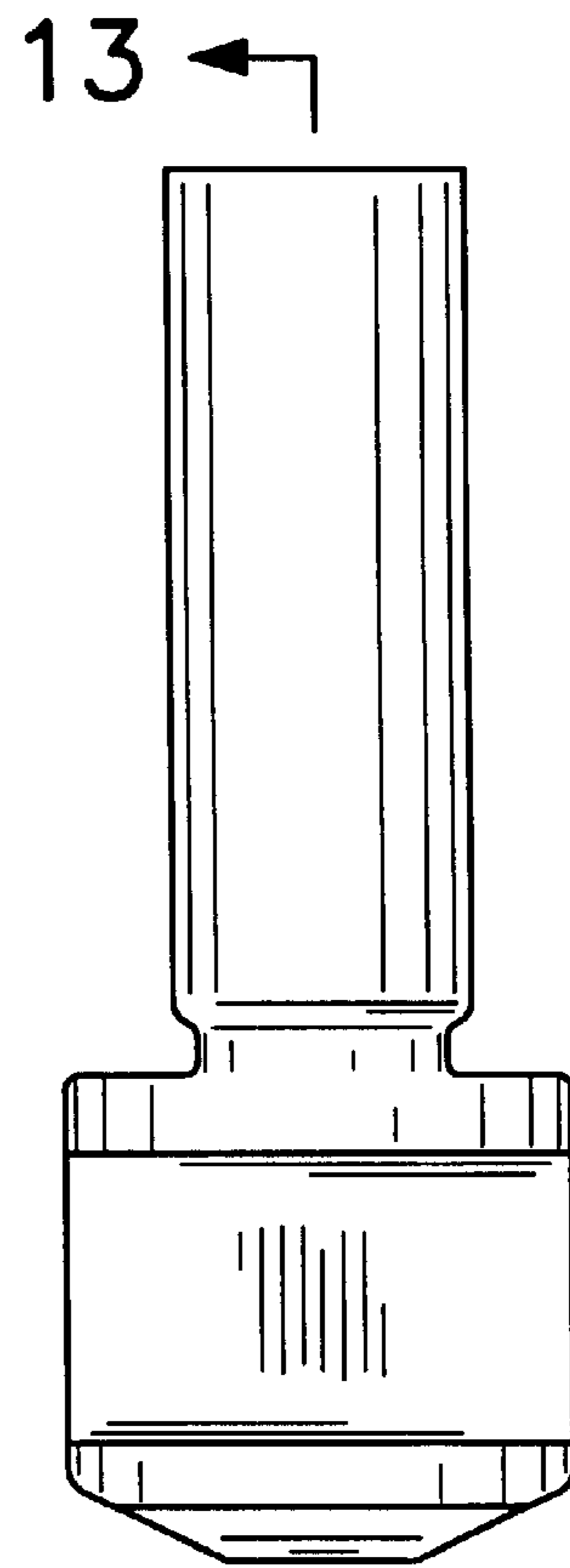

FIG. 9

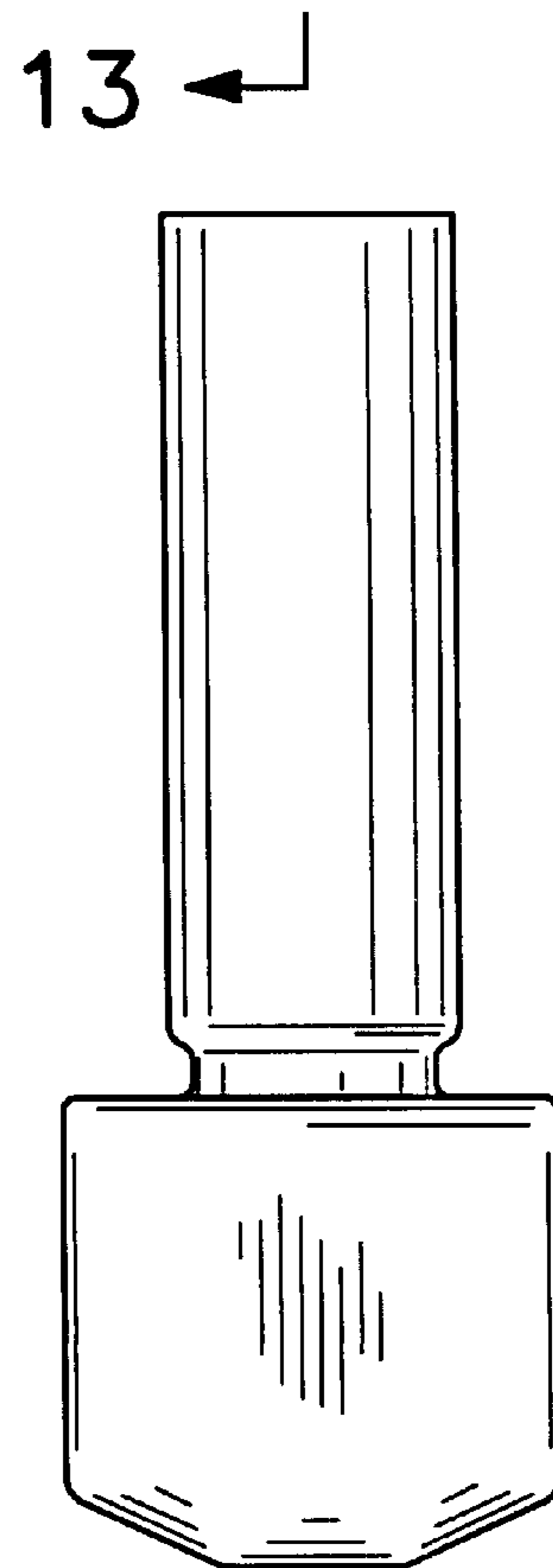

FIG. 10

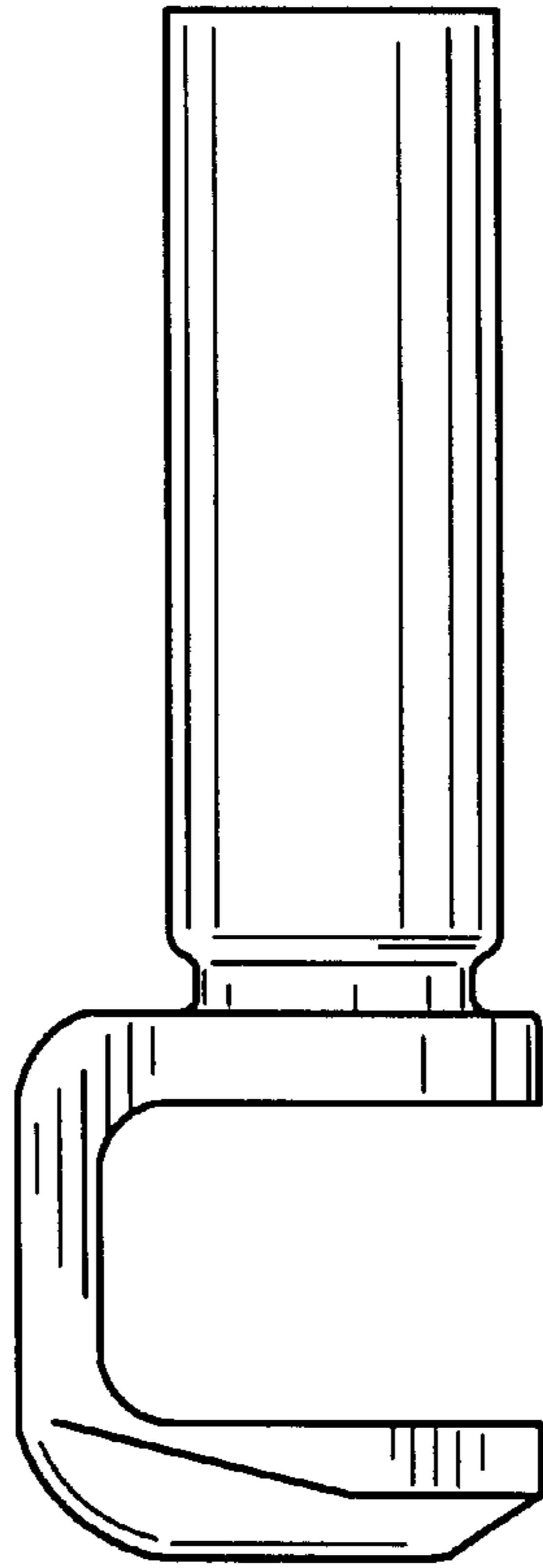

FIG. 11

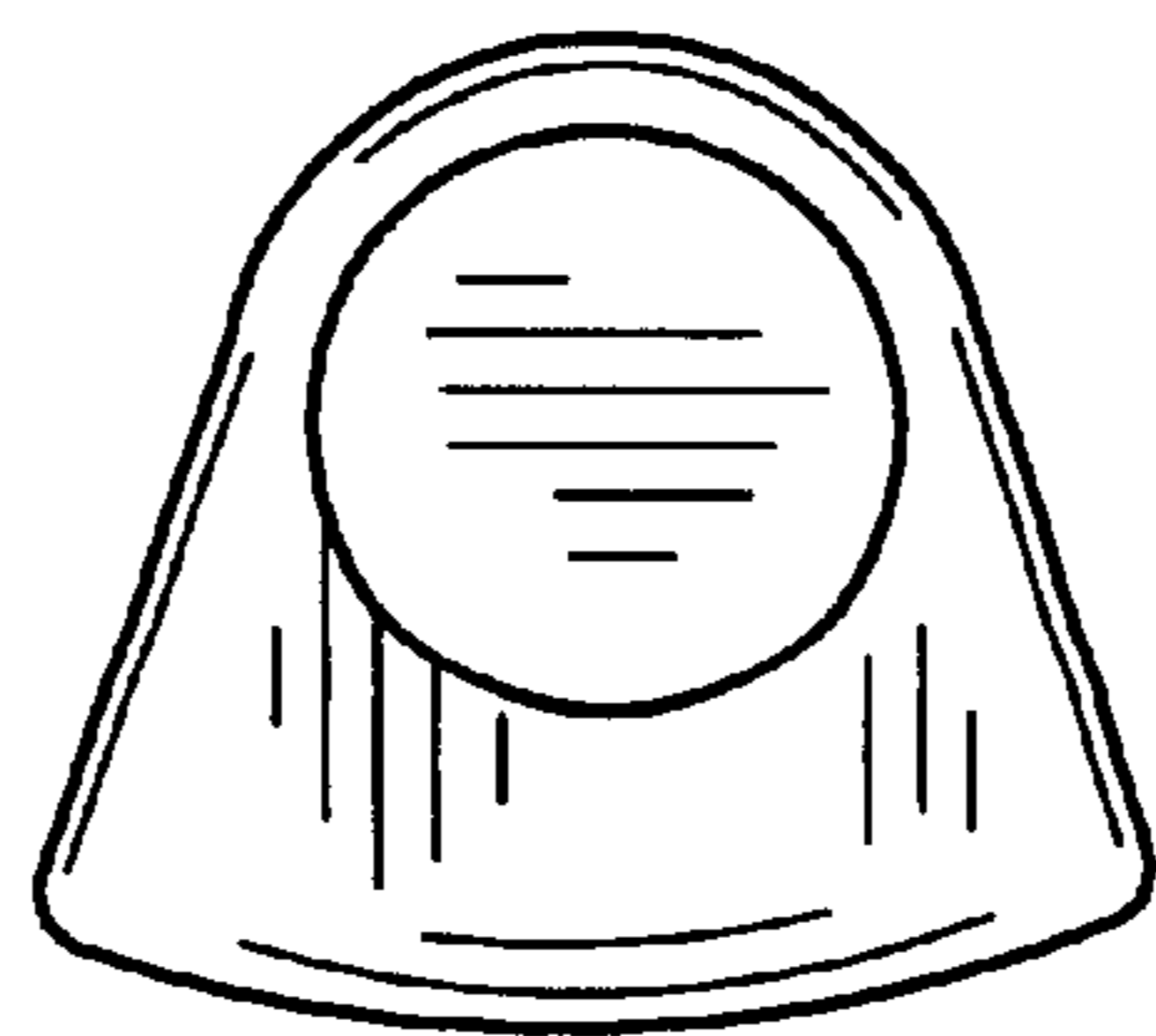

FIG. 12

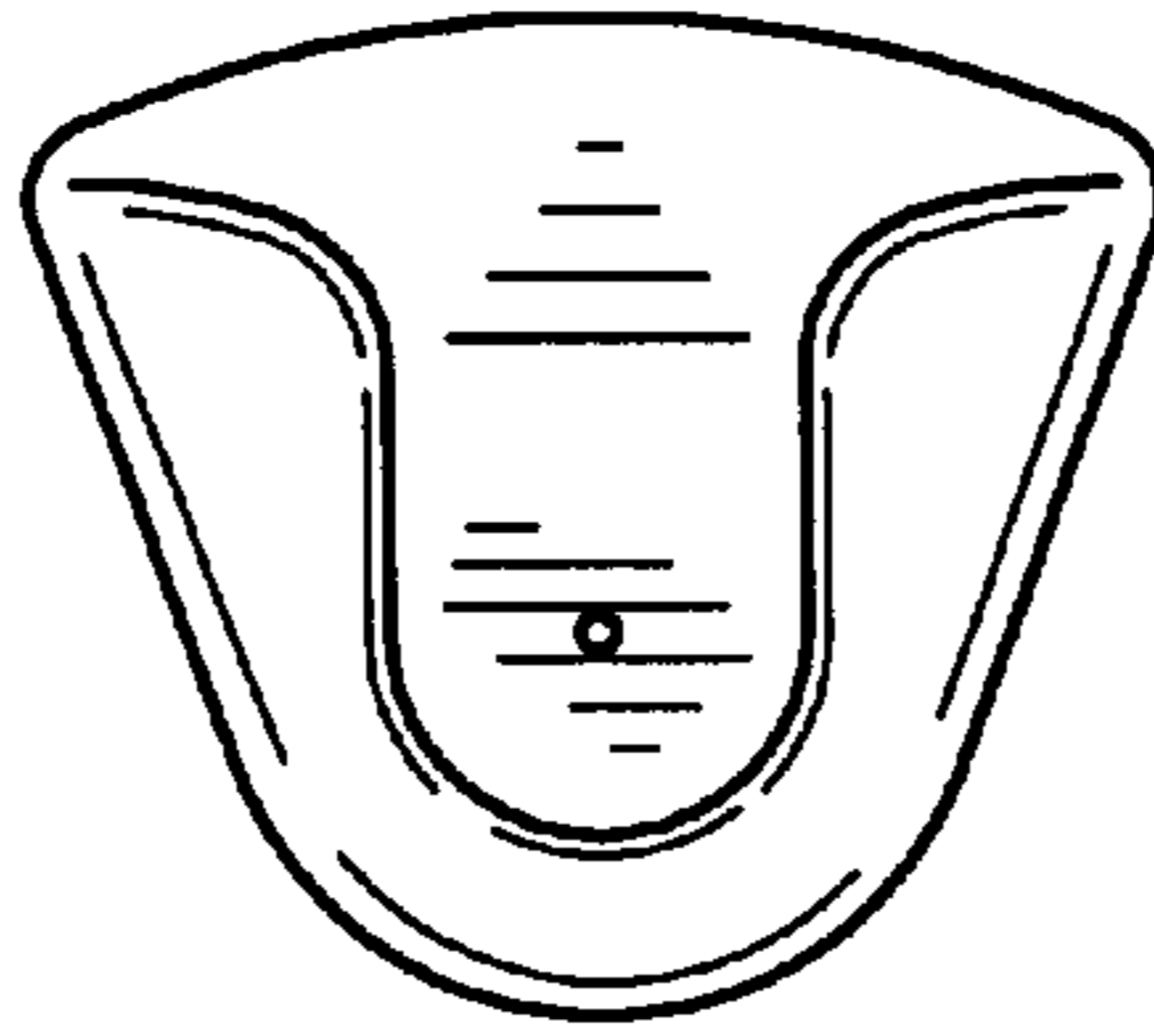

FIG. 13

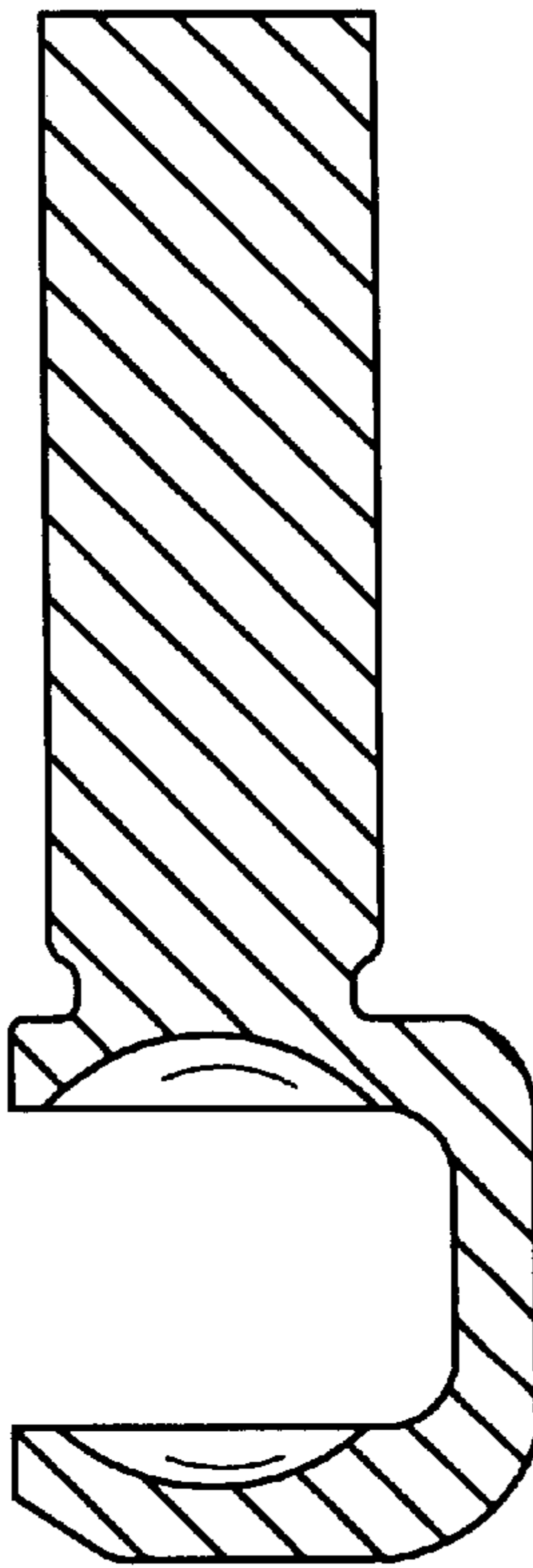

FIG. 14

