



US00D471099S

(12) **United States Design Patent**  
**Yang**

(10) **Patent No.:** **US D471,099 S**

(45) **Date of Patent:** **\*\* Mar. 4, 2003**

(54) **PACKING CASE FOR LOCK DEVICES**

(75) **Inventor:** **Peir-Ling Yang, Kaohsiung Hsien (TW)**

(73) **Assignee:** **Taiwan Fu Hsing Industrial Co., Ltd., Kaohsiung Hsien (TW)**

(\*\*) **Term:** **14 Years**

(21) **Appl. No.:** **29/156,852**

(22) **Filed:** **Mar. 11, 2002**

(51) **LOC (7) Cl.** ..... **09-03**

(52) **U.S. Cl.** ..... **D9/415**

(58) **Field of Search** ..... D9/337, 341, 347, D9/345, 414, 415, 418, 424, 425, 426, 431, 432; 206/320, 321, 459.1, 461, 462, 463, 464, 471, 485, 485.1, 775, 776, 779, 780; 220/4.22, 4.23, 4.24; 229/406

(56) **References Cited**

**U.S. PATENT DOCUMENTS**

- 4,512,474 A \* 4/1985 Harding ..... 206/461
- D320,934 S \* 10/1991 Cross et al. .... D9/415
- 5,129,516 A \* 7/1992 Theros ..... 206/463
- D333,613 S \* 3/1993 Theros ..... D9/415
- D365,753 S \* 1/1996 Sibbio ..... D9/415
- D400,098 S \* 10/1998 Wang ..... D9/415
- D415,417 S \* 10/1999 Suzuki ..... D9/415

- D420,578 S \* 2/2000 Plumer ..... D9/415
- D424,427 S \* 5/2000 Saputo et al. .... D9/415
- D441,645 S \* 5/2001 Longhurst ..... D9/415

\* cited by examiner

*Primary Examiner*—Ted Shooman

*Assistant Examiner*—Daniel Bui

(74) *Attorney, Agent, or Firm*—Bacon & Thomas, PLLC

(57) **CLAIM**

The ornamental design for packing case for lock devices, as shown.

**DESCRIPTION**

FIG. 1 is a perspective view of the packing case for lock devices in accordance with the embodiment of the claimed design;

FIG. 2 is a right side elevational view thereof in a reduced scale;

FIG. 3 is a top plan view thereof in a reduced scale;

FIG. 4 is a front elevational view thereof in a reduced scale;

FIG. 5 is a bottom plan view thereof in a reduced scale;

FIG. 6 is a left side elevational view thereof in a reduced scale;

FIG. 7 is a rear elevational view thereof in a reduced scale; and,

FIG. 8 is a perspective view thereof in a reduced scale, and in open condition.

**1 Claim, 5 Drawing Sheets**

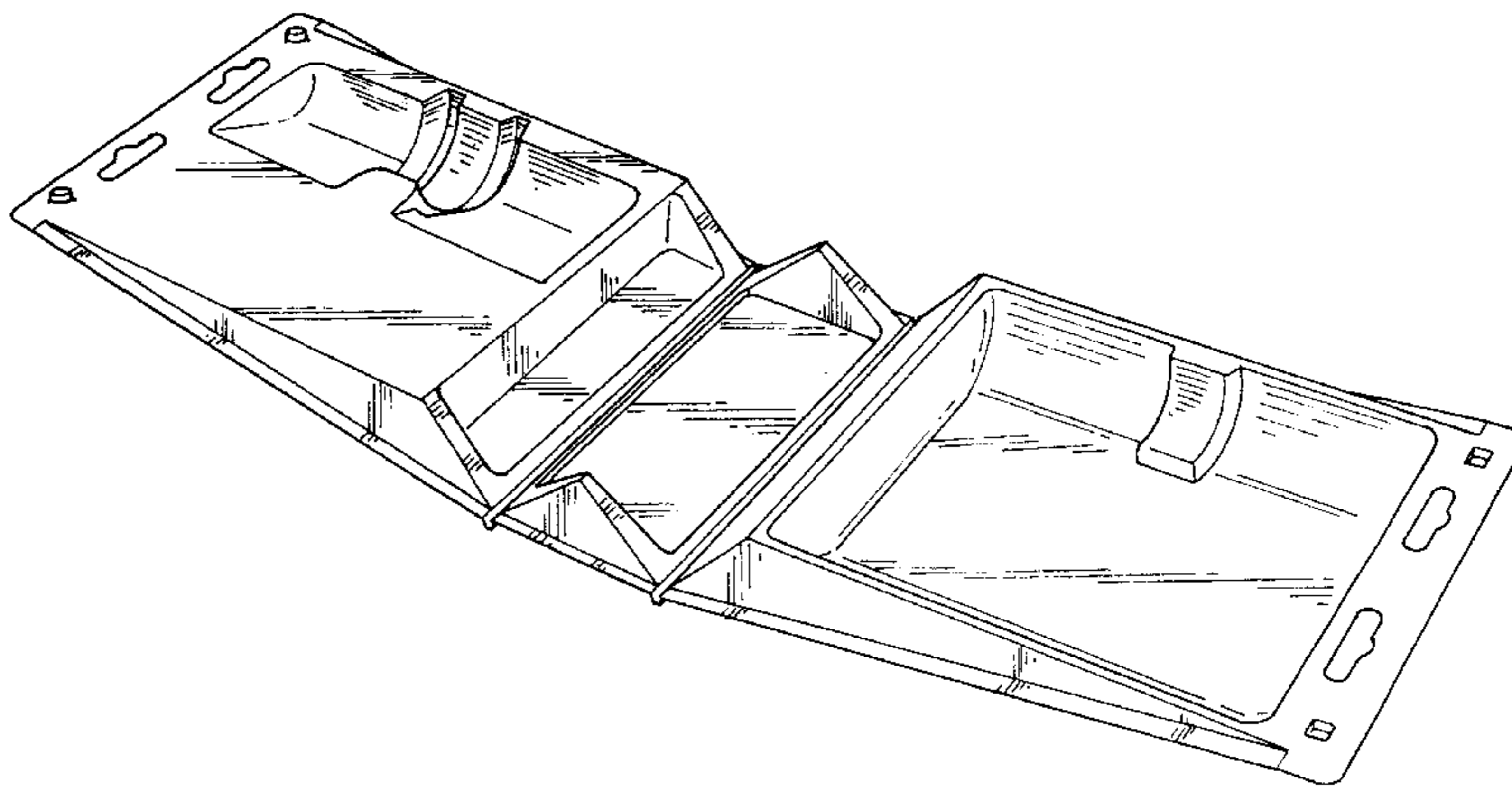
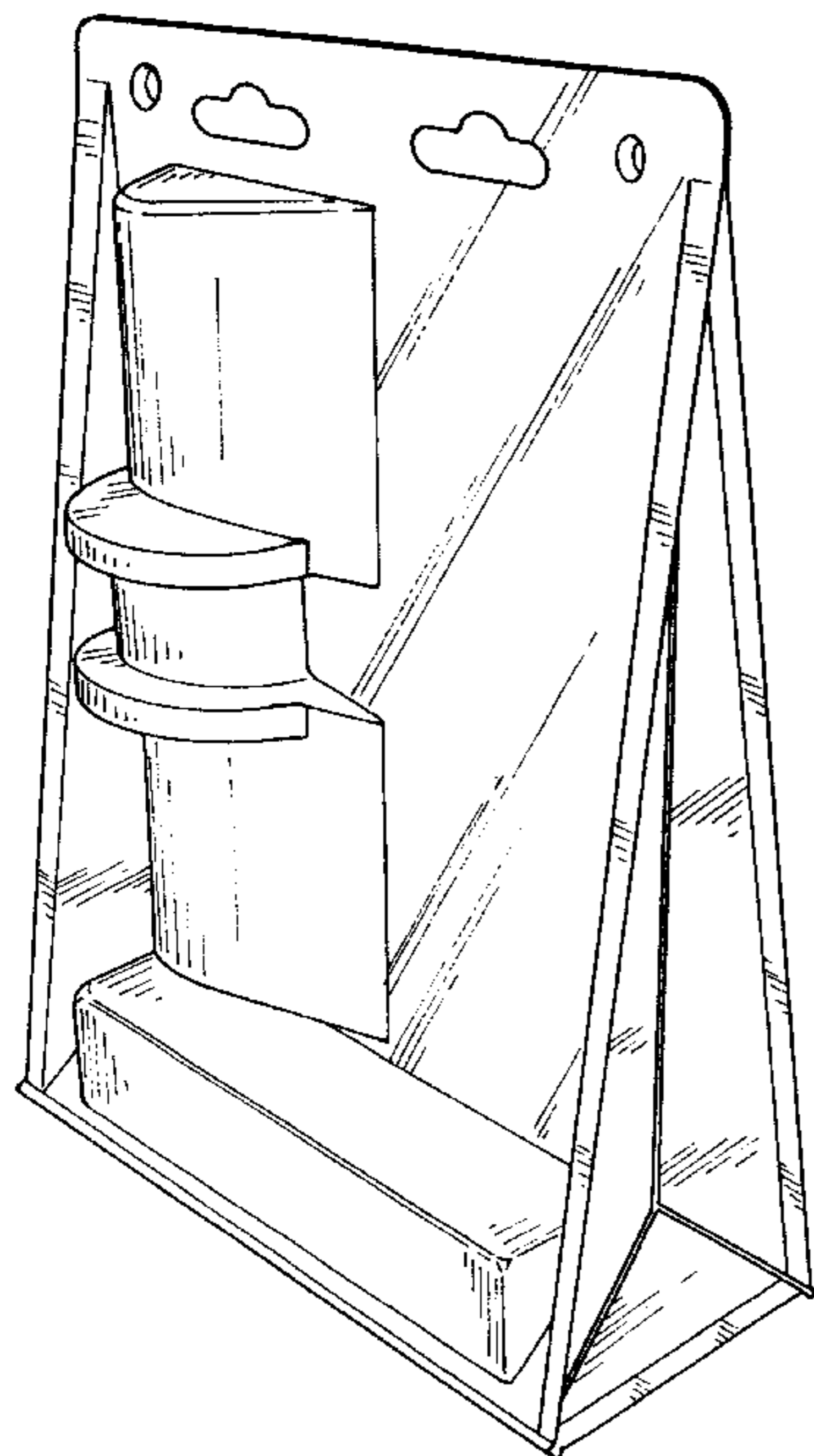

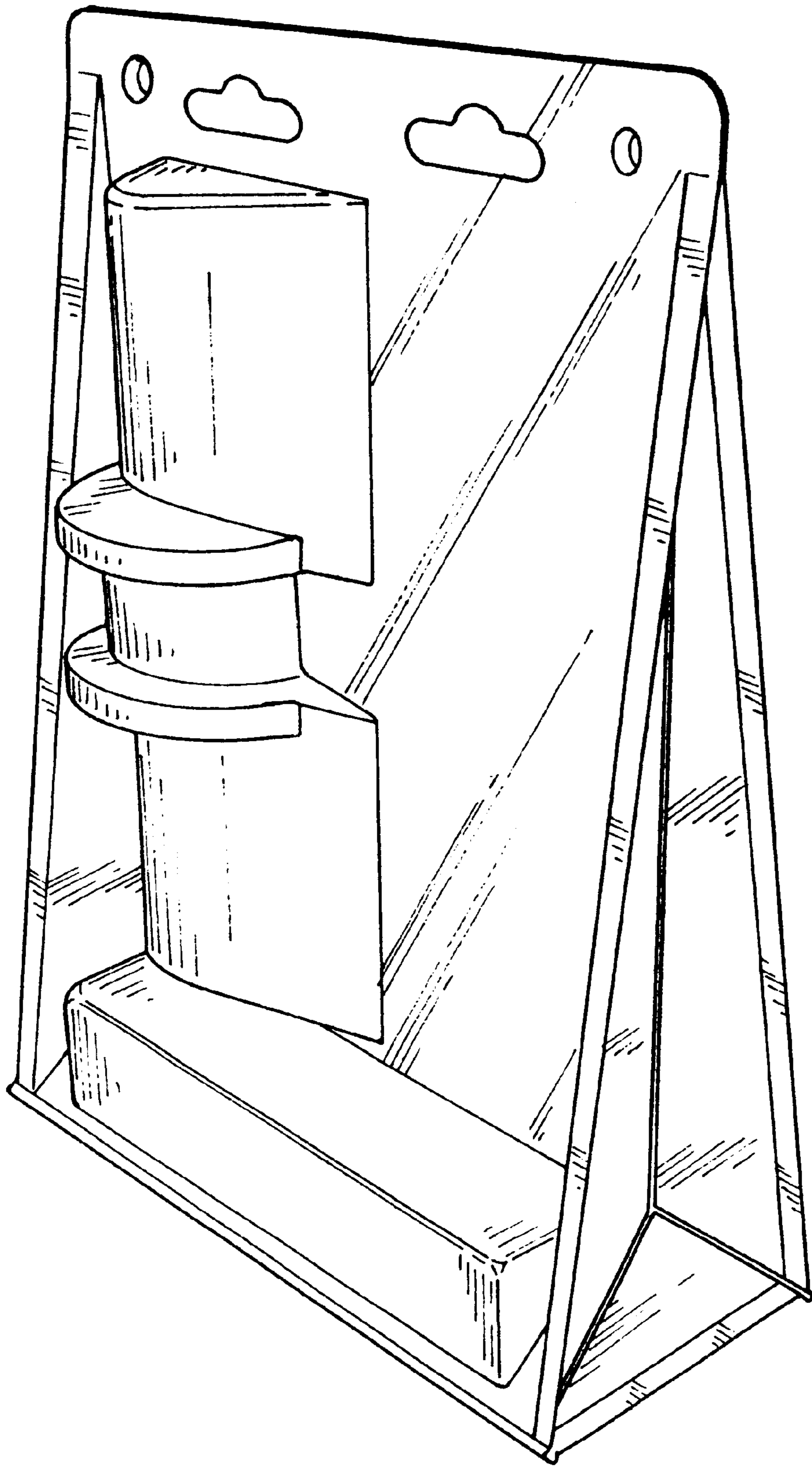
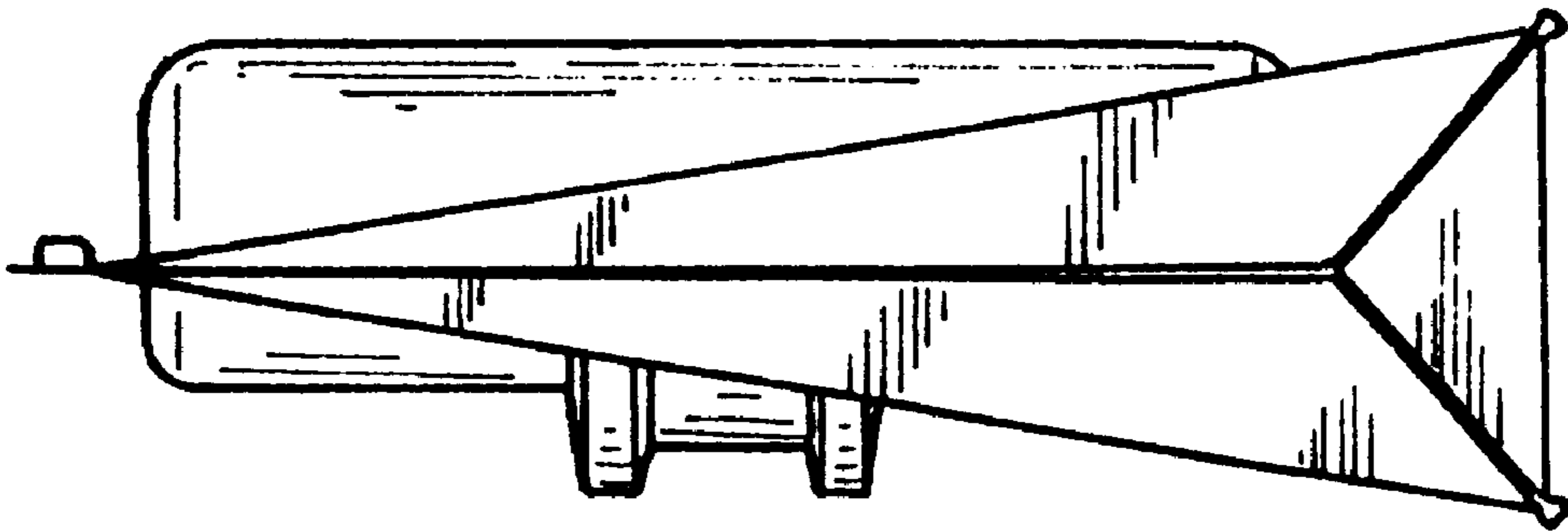
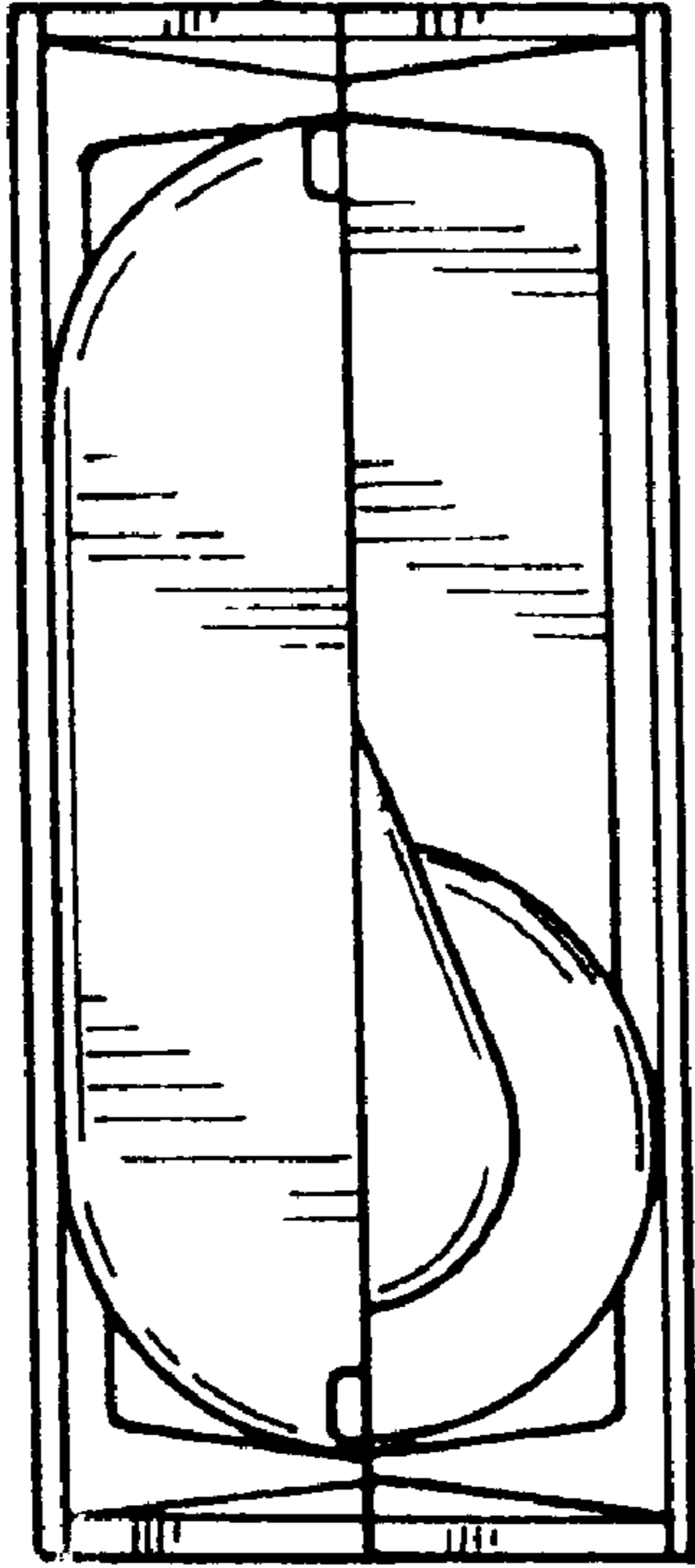

FIG. 1



**FIG. 2**



**FIG. 3**

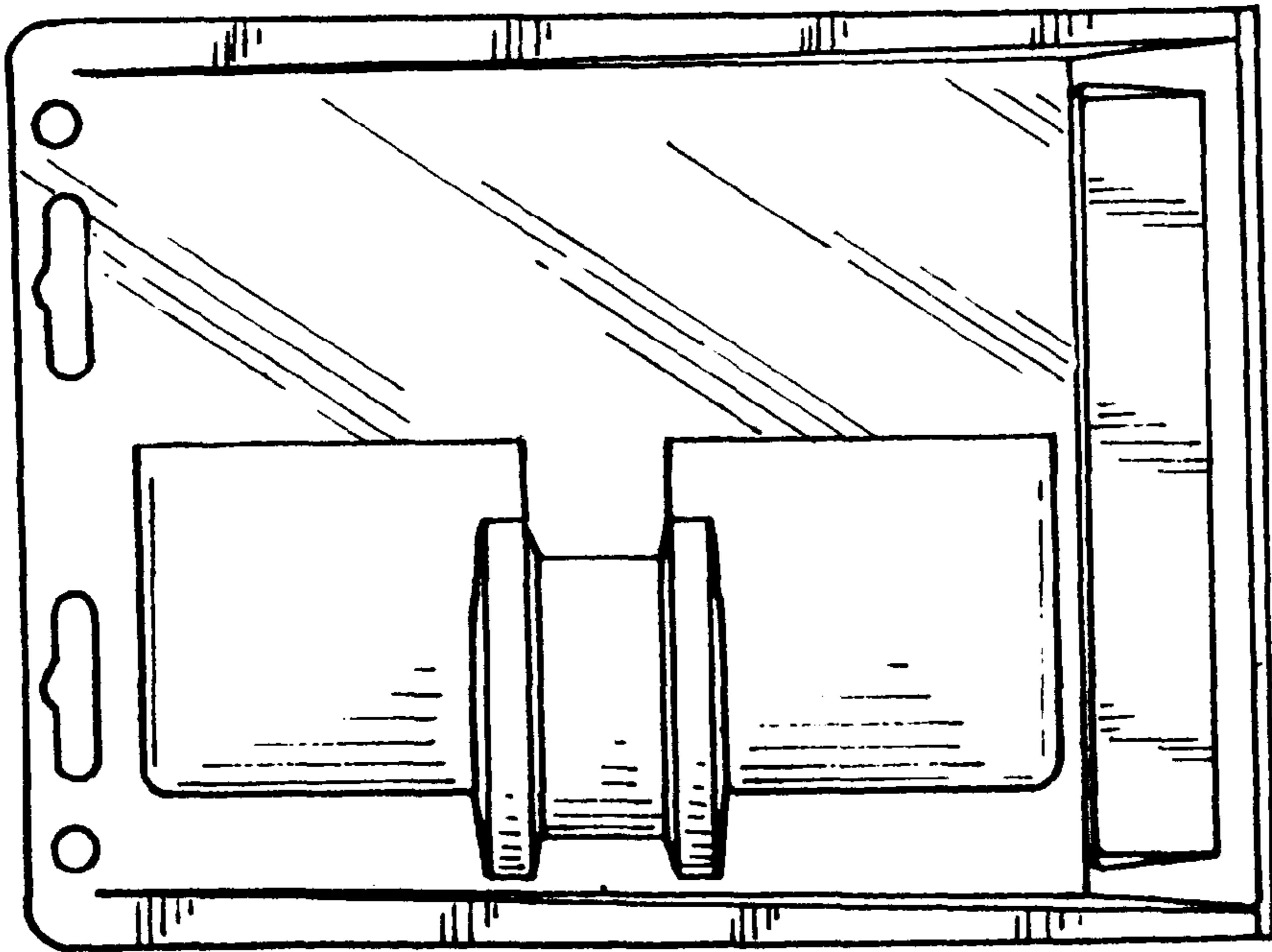

**FIG. 4**

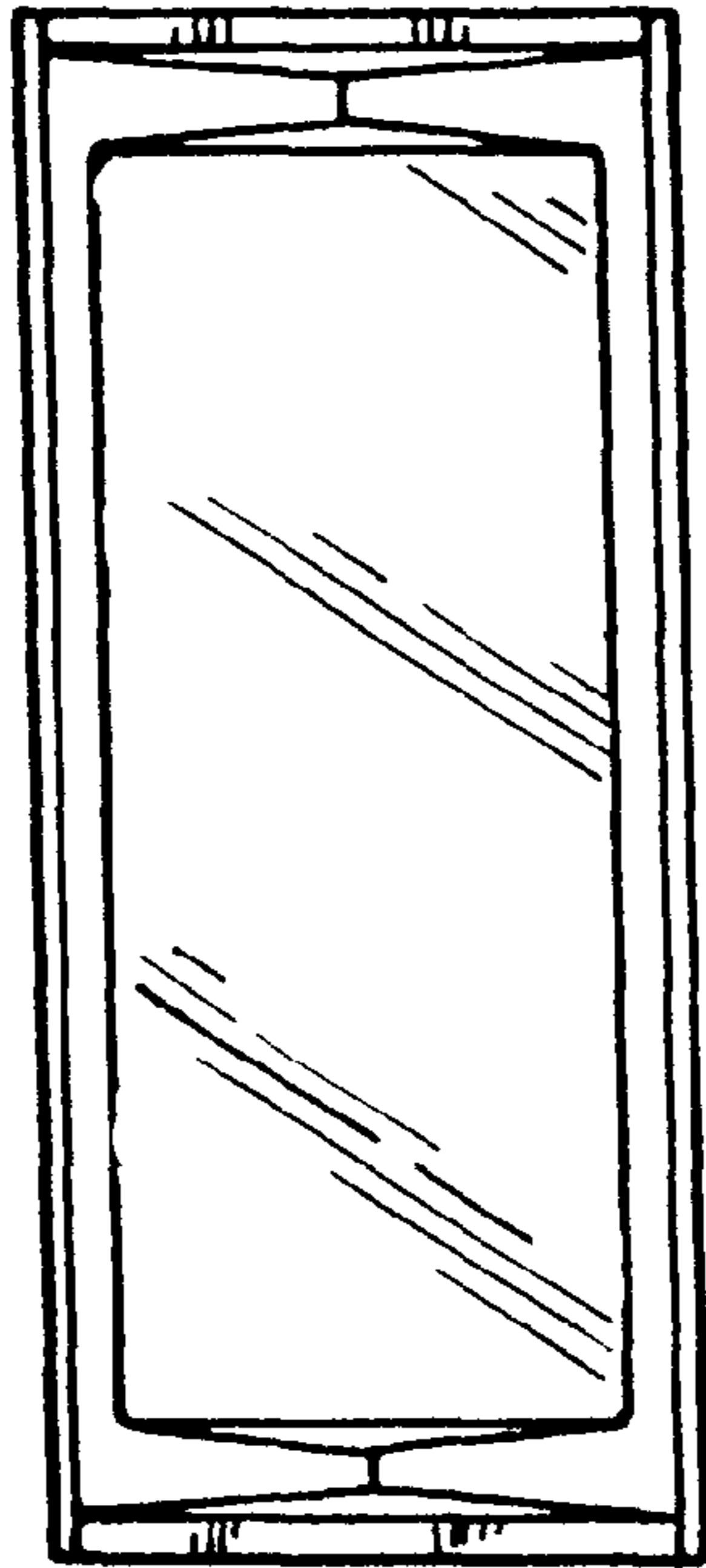

**FIG. 5**

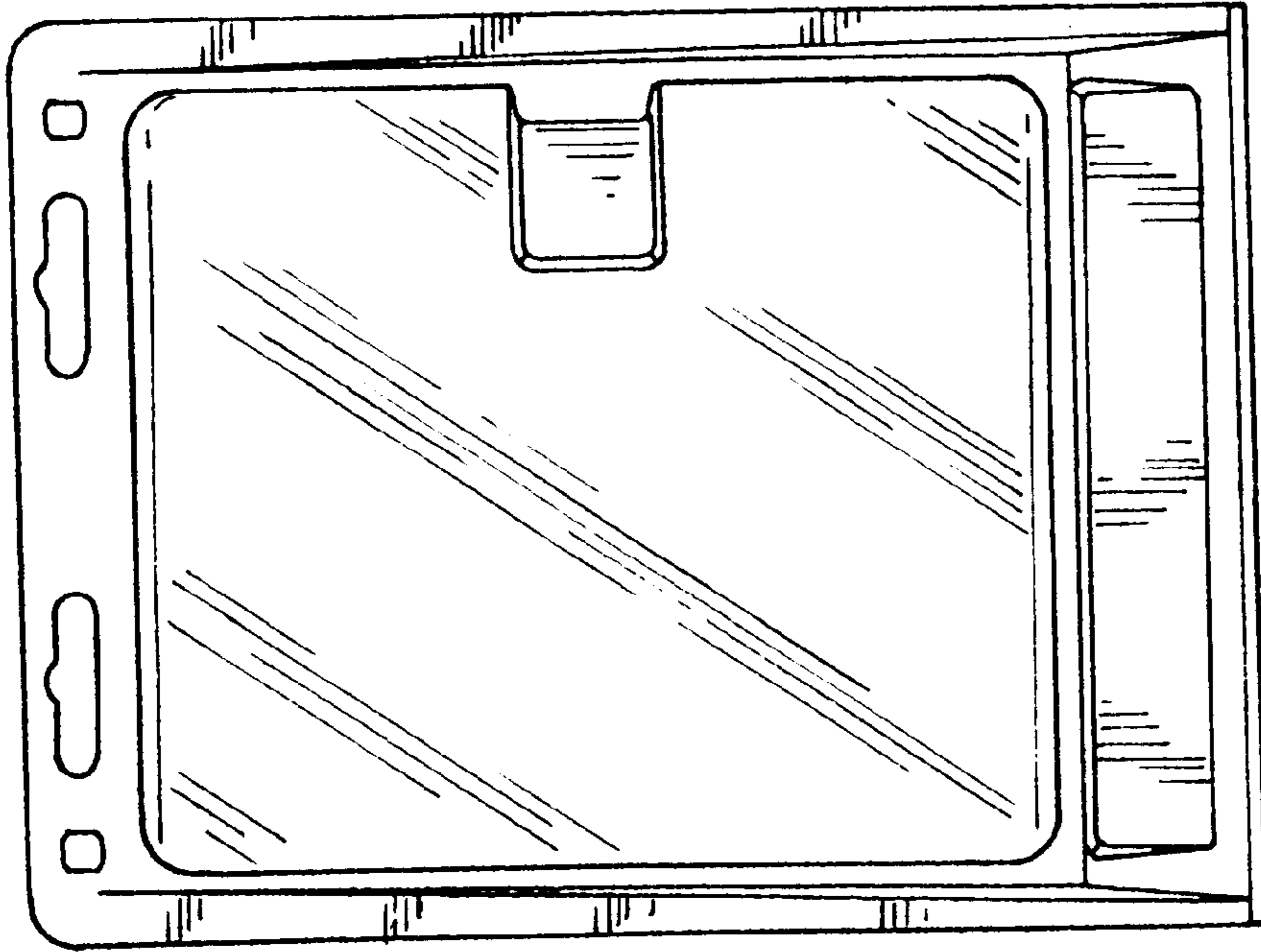

FIG. 7

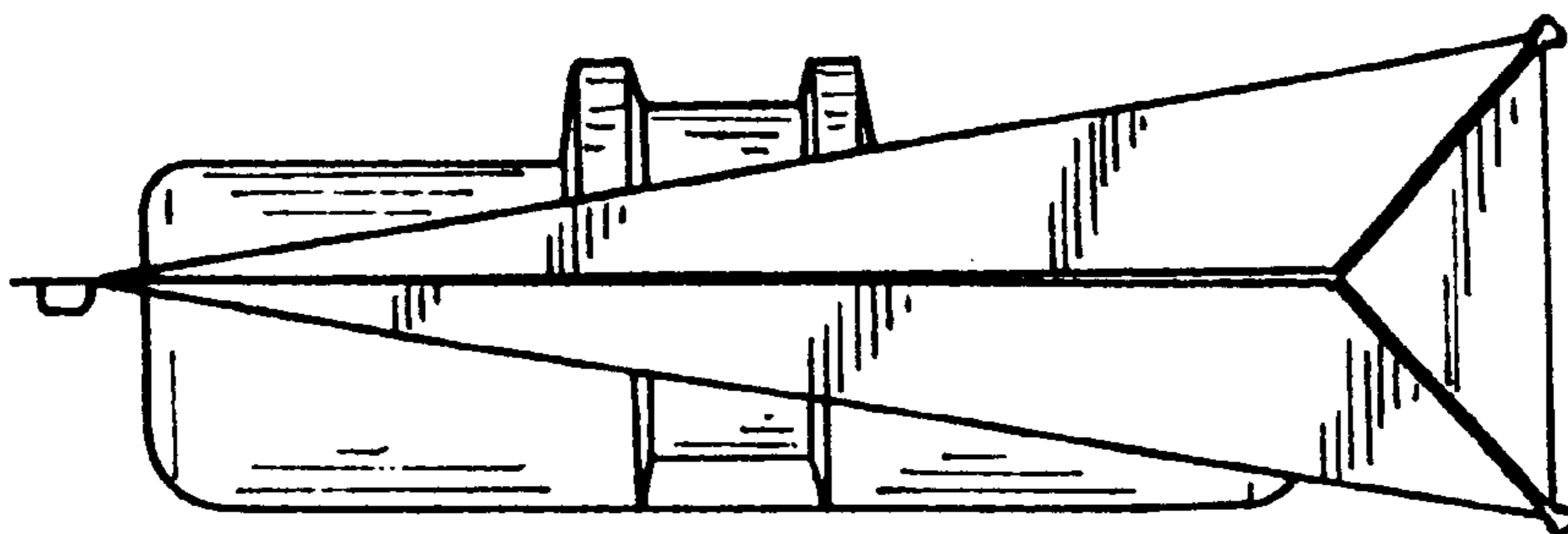

FIG. 6

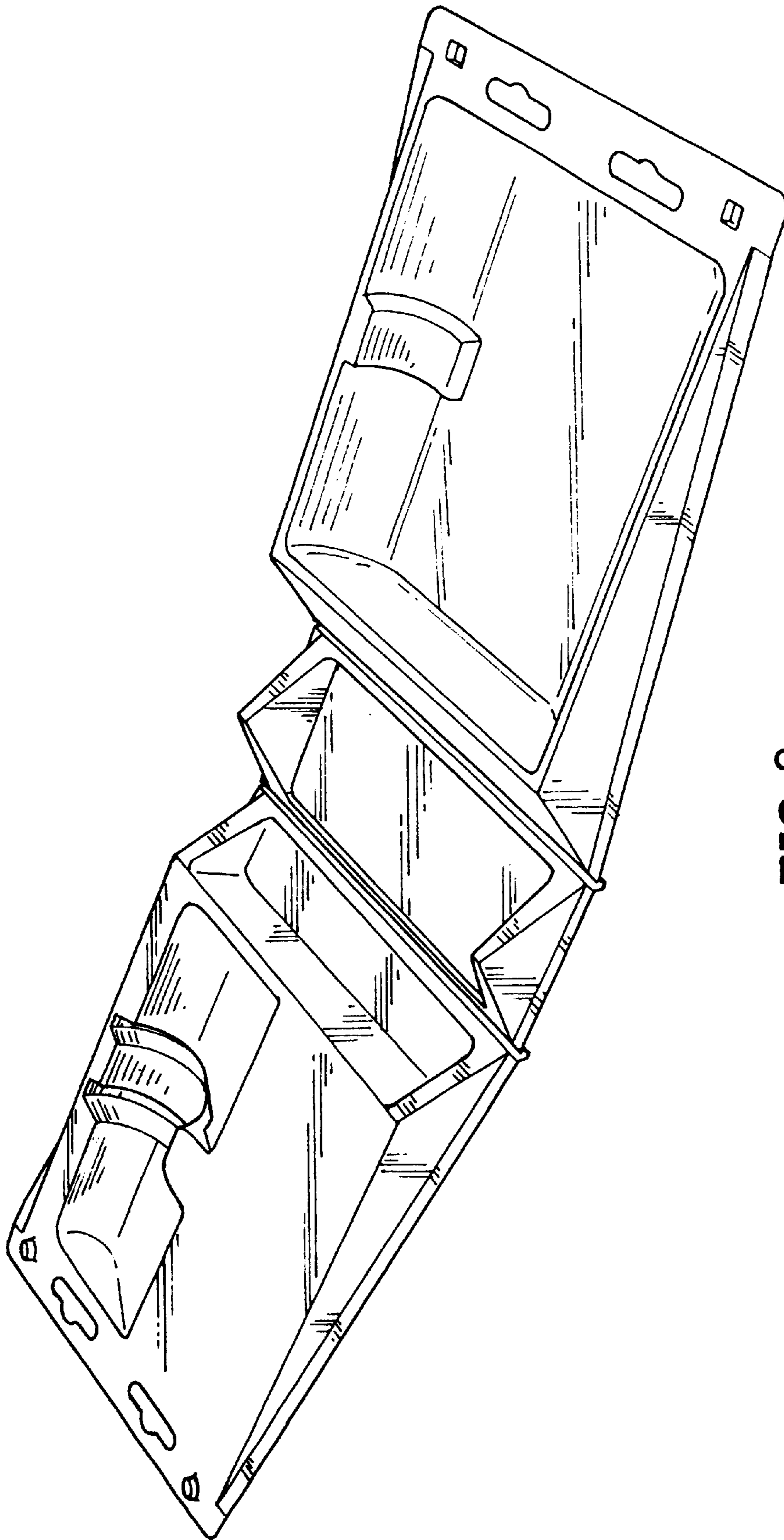

FIG. 8