



US00D471084S

(12) **United States Design Patent**
Nemoto

(10) **Patent No.:** **US D471,084 S**

(45) **Date of Patent:** **** Mar. 4, 2003**

(54) **MALE MEMBER OF A CONNECTOR**

(75) **Inventor:** **Takehiko Nemoto, Hiroshima (JP)**

(73) **Assignee:** **Nifco Inc., Yokohama (JP)**

(**) **Term:** **14 Years**

(21) **Appl. No.:** **29/160,684**

(22) **Filed:** **May 16, 2002**

(30) **Foreign Application Priority Data**

Nov. 19, 2001 (JP) 2001-033815

(51) **LOC (7) Cl.** **08-08**

(52) **U.S. Cl.** **D8/382**

(58) **Field of Search** D8/382, 499, 394-396;
411/968, 109, 455, 451.1, 15, 45, 48, 51,
55, 937.1, 500, 508-510, 913, 923; 24/453

(56) **References Cited**

U.S. PATENT DOCUMENTS

- 4,427,328 A * 1/1984 Kojima 411/508
- 4,506,419 A * 3/1985 Mitomi 24/297
- 4,524,494 A * 6/1985 Sato et al. 24/453
- 4,527,821 A * 7/1985 Tanaka 292/19
- 4,712,939 A * 12/1987 Fujimoto 403/24

- D299,004 S * 12/1988 Fujimoto D8/382
- 5,333,965 A * 8/1994 Mailey 403/326
- 5,393,185 A * 2/1995 Duffy, Jr. 411/510
- D382,468 S * 8/1997 Takahashi D8/382

* cited by examiner

Primary Examiner—Alan P. Douglas

Assistant Examiner—Clare E. Heflin

(74) *Attorney, Agent, or Firm*—Kanesaka & Takeuchi

(57) **CLAIM**

The ornamental design for a male member of a connector, as shown and described.

DESCRIPTION

FIG. 1 is a front view of a male member of a connector showing my new design, the rear view thereof being identical to the front view;

FIG. 2 is a right side view thereof, the left side view thereof being identical to the right side view;

FIG. 3 is a top plan view thereof;

FIG. 4 is a bottom plan view thereof;

FIG. 5 is a cross sectional view taken along line 5—5 in FIG. 3; and,

FIG. 6 is a cross sectional view taken along line 6—6 in FIG. 3.

1 Claim, 1 Drawing Sheet

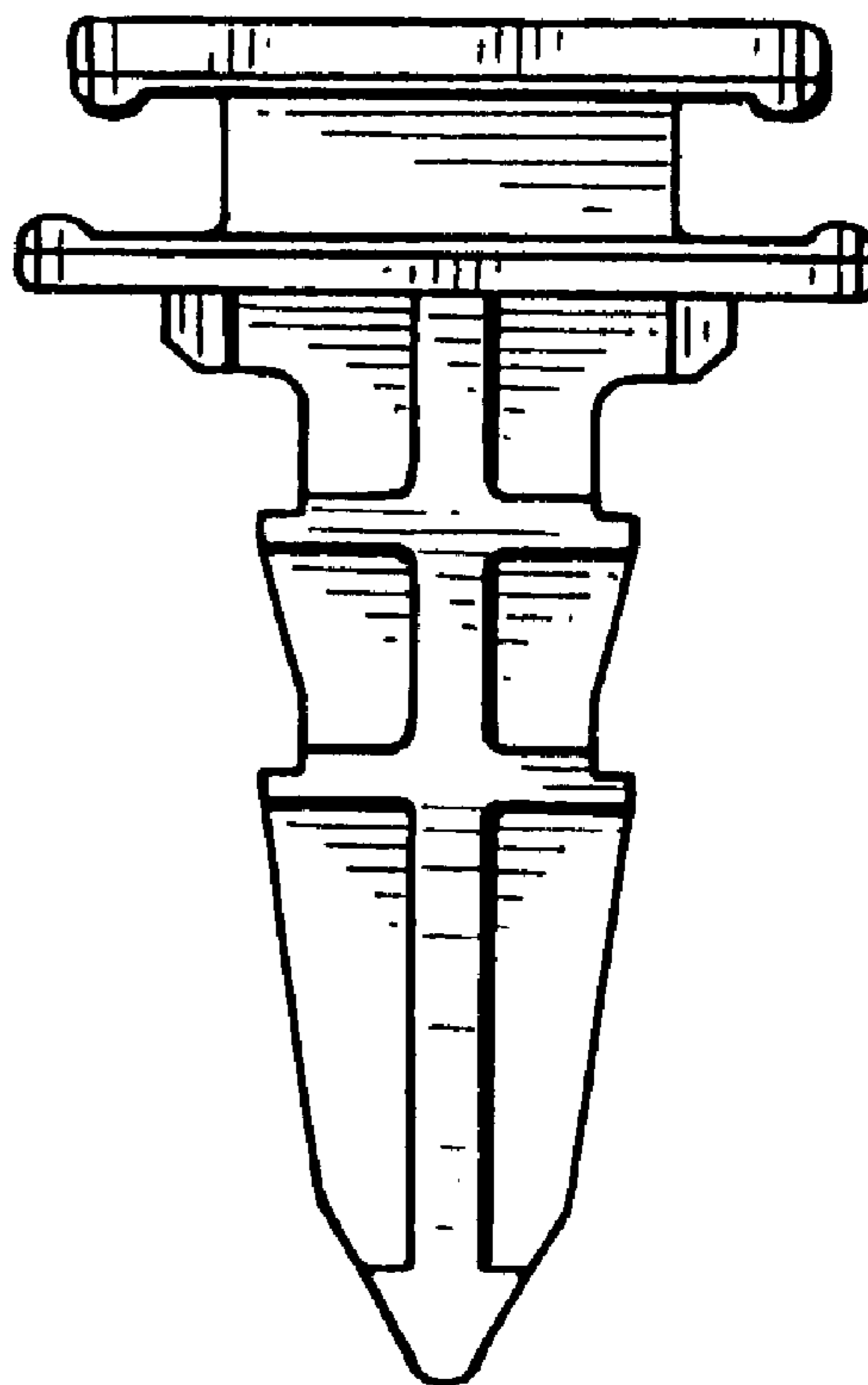
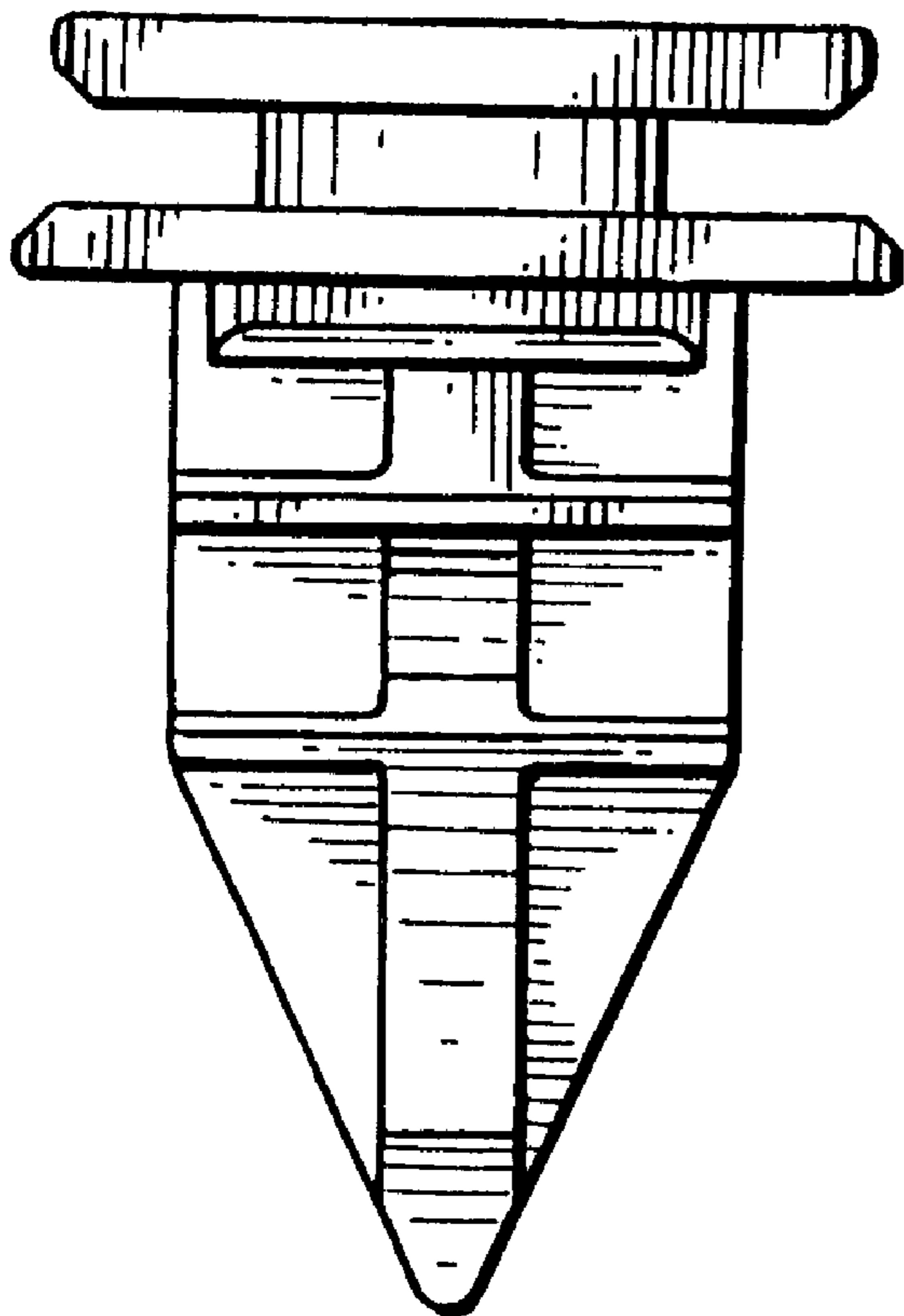

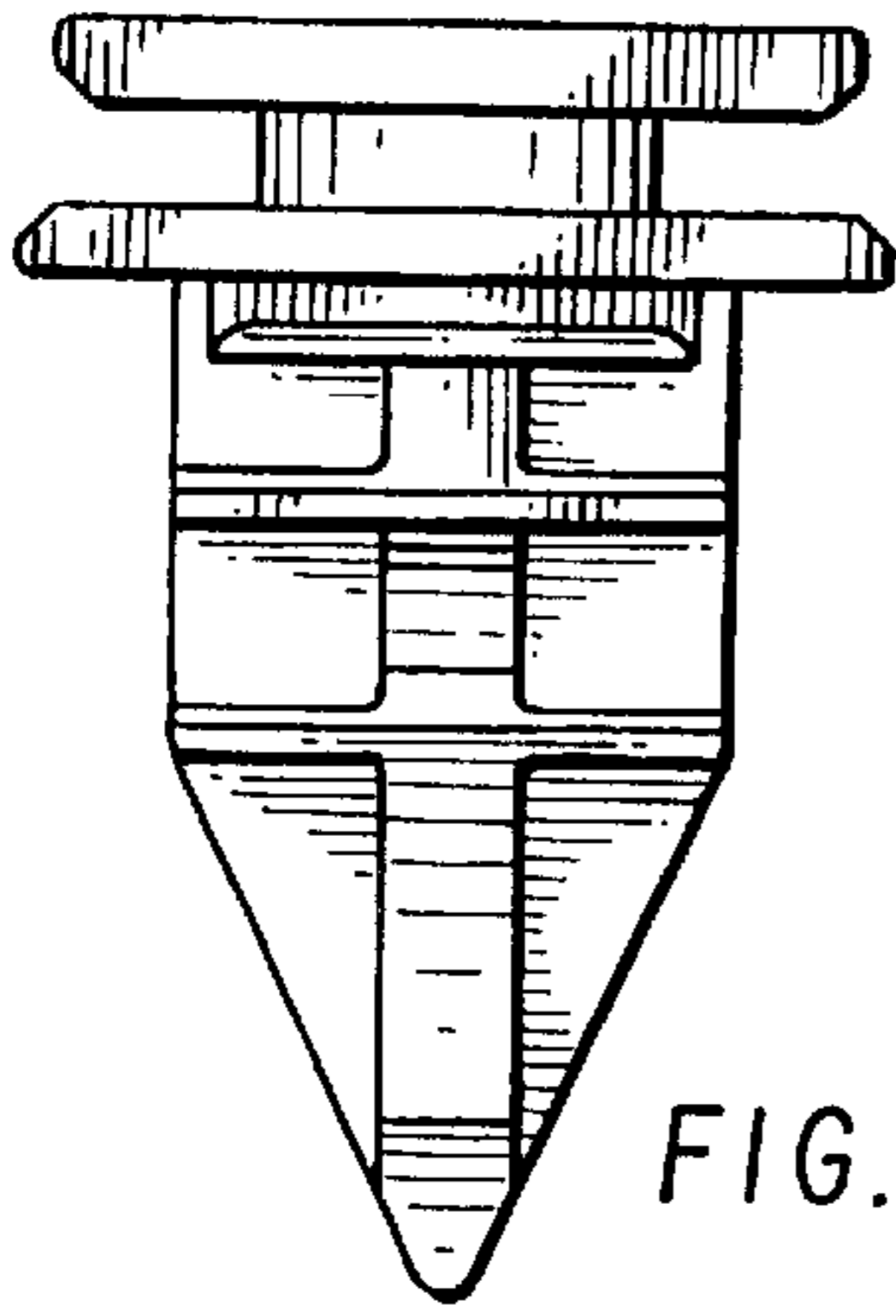

FIG. 1

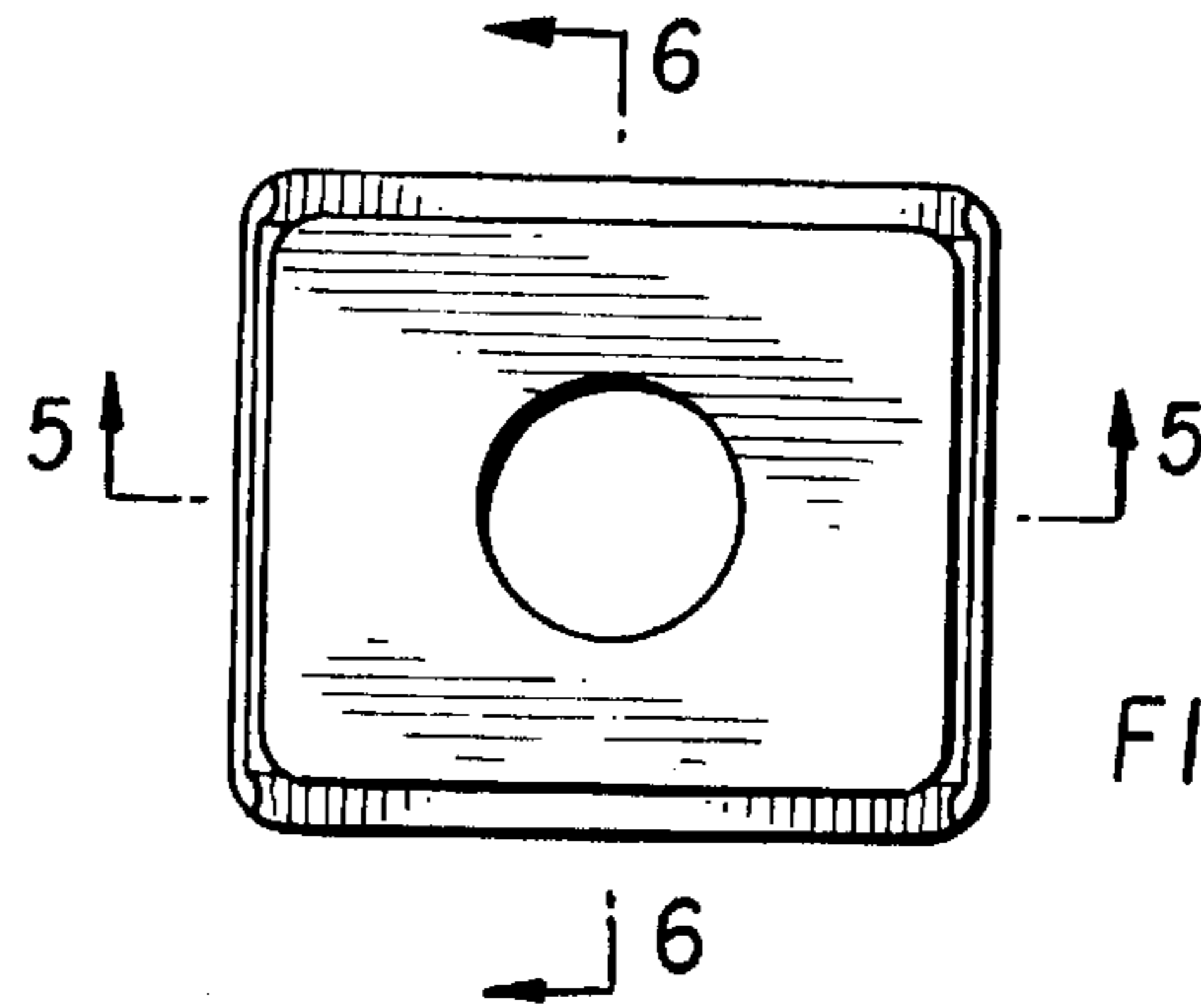

FIG. 3

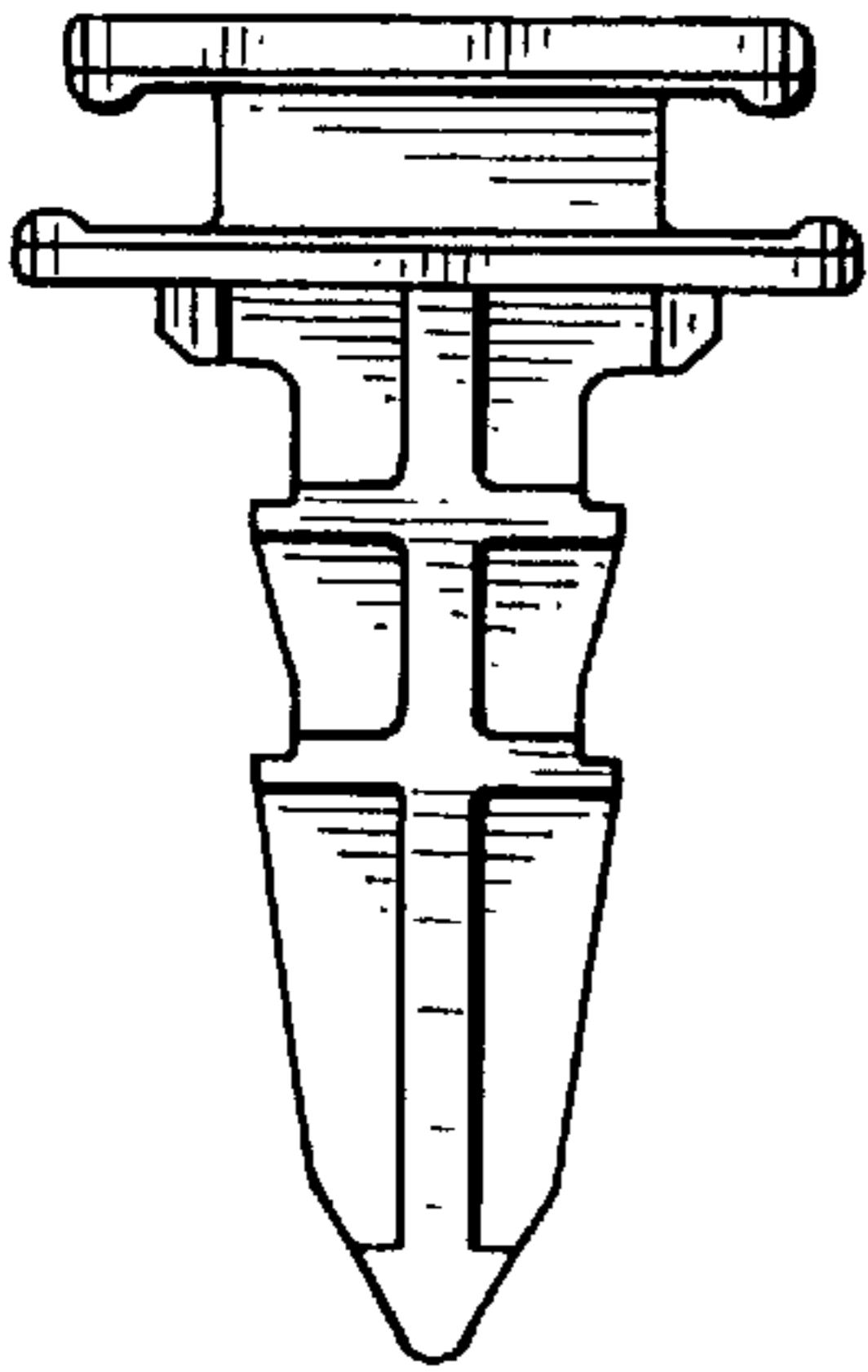

FIG. 2

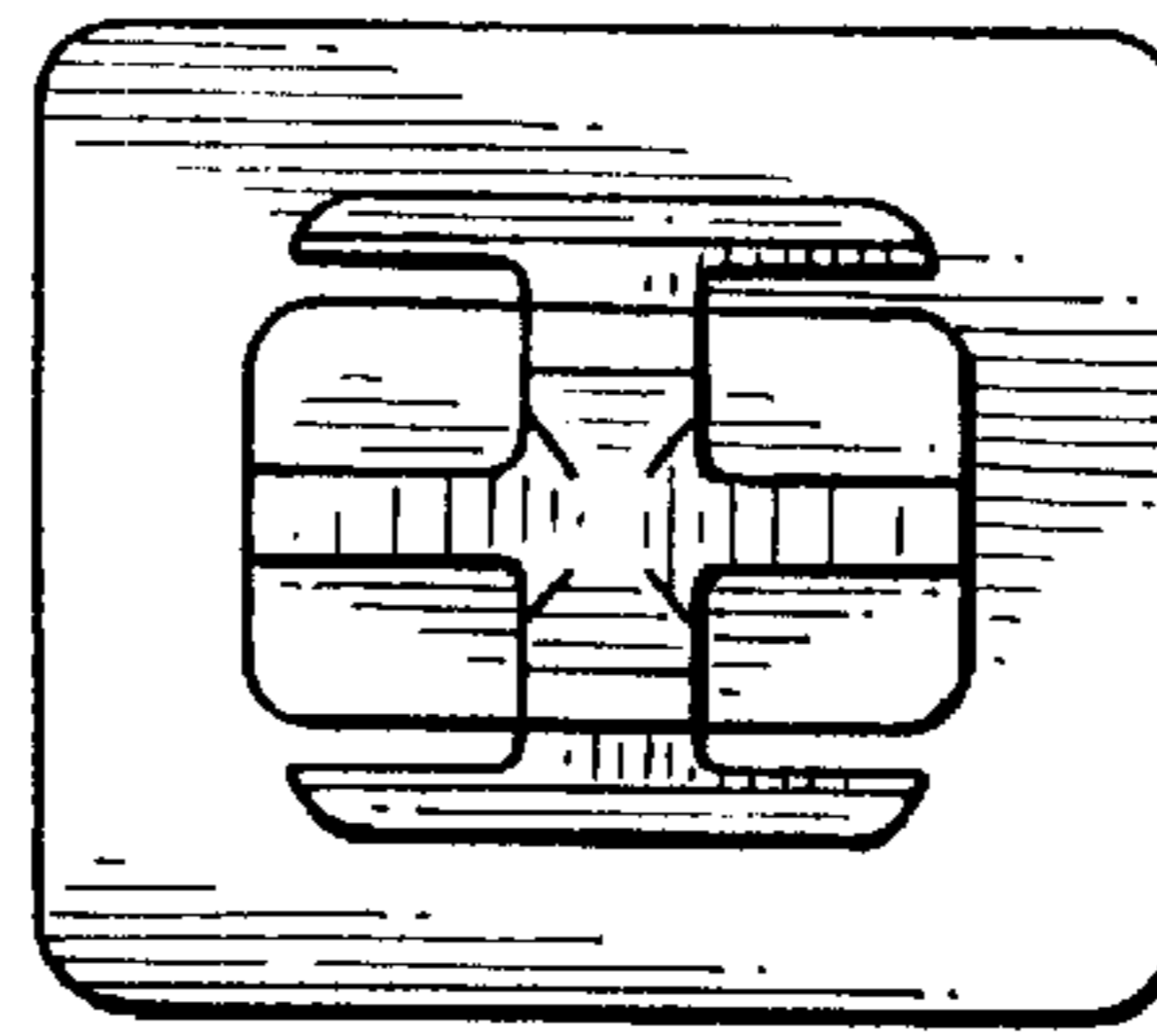

FIG. 4

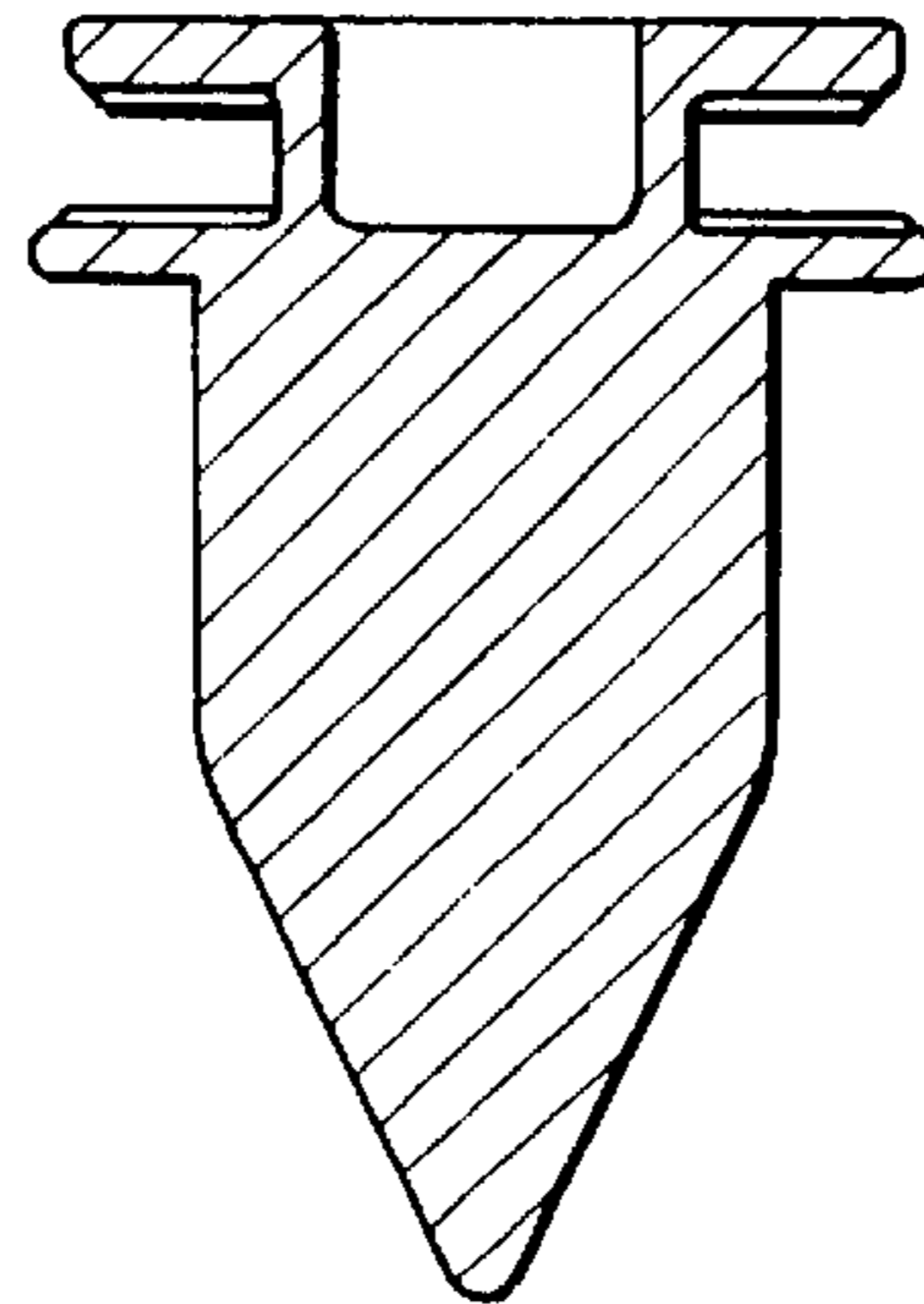

FIG. 5

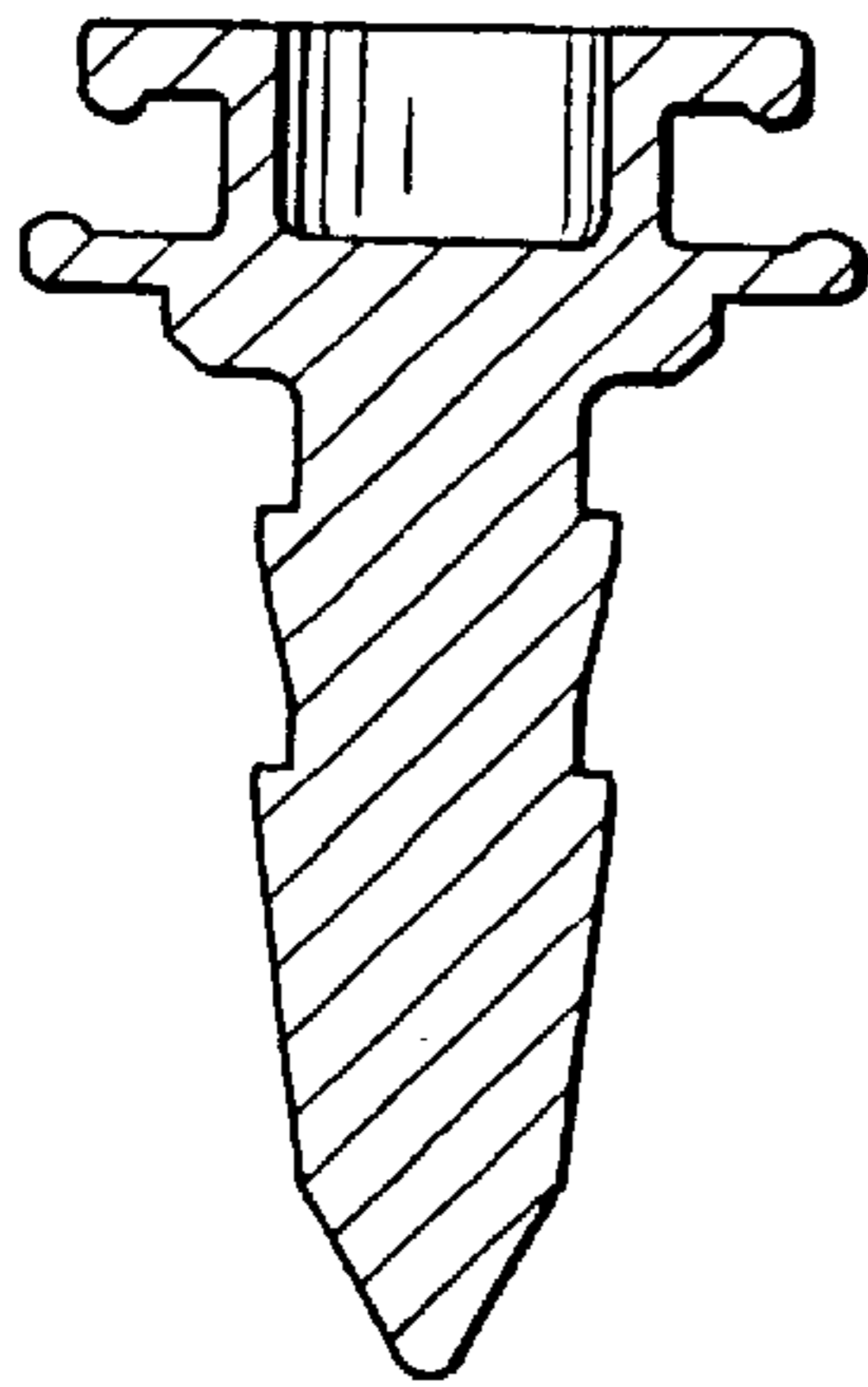

FIG. 6