



US00D471037S

(12) **United States Design Patent**
Lenger

(10) **Patent No.:** **US D471,037 S**

(45) **Date of Patent:** **** Mar. 4, 2003**

(54) **CHEST COMPONENT**

(75) **Inventor:** **Sidney A. Lenger**, Kernersville, NC
(US)

(73) **Assignee:** **Schottenstein Stores Corporation**,
Columbus, OH (US)

(**) **Term:** **14 Years**

(21) **Appl. No.:** **29/159,478**

(22) **Filed:** **Apr. 22, 2002**

(51) **LOC (7) Cl.** **06-06**

(52) **U.S. Cl.** **D6/492; D6/495**

(58) **Field of Search** **D6/432-448, 470;**
312/204, 224, 237, 278, 279

(56) **References Cited**

U.S. PATENT DOCUMENTS

| | | | | | |
|------------|---|---------|---------------------|-------|--------|
| D386,628 S | * | 11/1997 | O'Hare | | D6/445 |
| D401,082 S | * | 11/1998 | O'Hare | | D6/446 |
| D425,329 S | * | 5/2000 | O'Hare | | D6/445 |
| D430,427 S | * | 9/2000 | Cain | | D6/446 |
| D430,429 S | * | 9/2000 | Walters, III et al. | | D6/446 |
| D430,980 S | * | 9/2000 | Cain | | D6/445 |
| D439,438 S | * | 3/2001 | Mathieu et al. | | D6/436 |
| D440,073 S | * | 4/2001 | Cain | | D6/446 |
| D450,476 S | * | 11/2001 | Vaaler | | D6/441 |

* cited by examiner

Primary Examiner—Cathron C. Brooks

(74) *Attorney, Agent, or Firm*—Wood, Herron & Evans,
L.L.P.

(57) **CLAIM**

The ornamental design for the chest component, as shown
and described.

DESCRIPTION

FIG. 1 is a front elevational view of a first embodiment of
my new design for a chest component, showing it incorpo-
rated in a six-drawer chest.

FIG. 2 is a left side elevational view thereof.

FIG. 3 is a rear elevational view thereof.

FIG. 4 is a right side elevational view thereof

FIG. 5 is a top plan view thereof.

FIG. 6 is a bottom plan view thereof.

The broken line elements of the chest are solely to illustrate
the first embodiment of my design, and form no part of the
claimed design.

FIG. 7 is a front elevational view of a second embodiment
of my new design for a chest component, showing it
incorporated in a six-drawer chest.

FIG. 8 is a left side elevational view thereof.

FIG. 9 is a rear elevational view thereof.

FIG. 10 is a right side elevational view thereof.

FIG. 11 is a top plan view thereof; and,

FIG. 12 is a bottom plan view thereof.

The broken line elements of the chest are solely to illustrate
the second embodiment of my design, and form no part of
the claimed design.

1 Claim, 8 Drawing Sheets

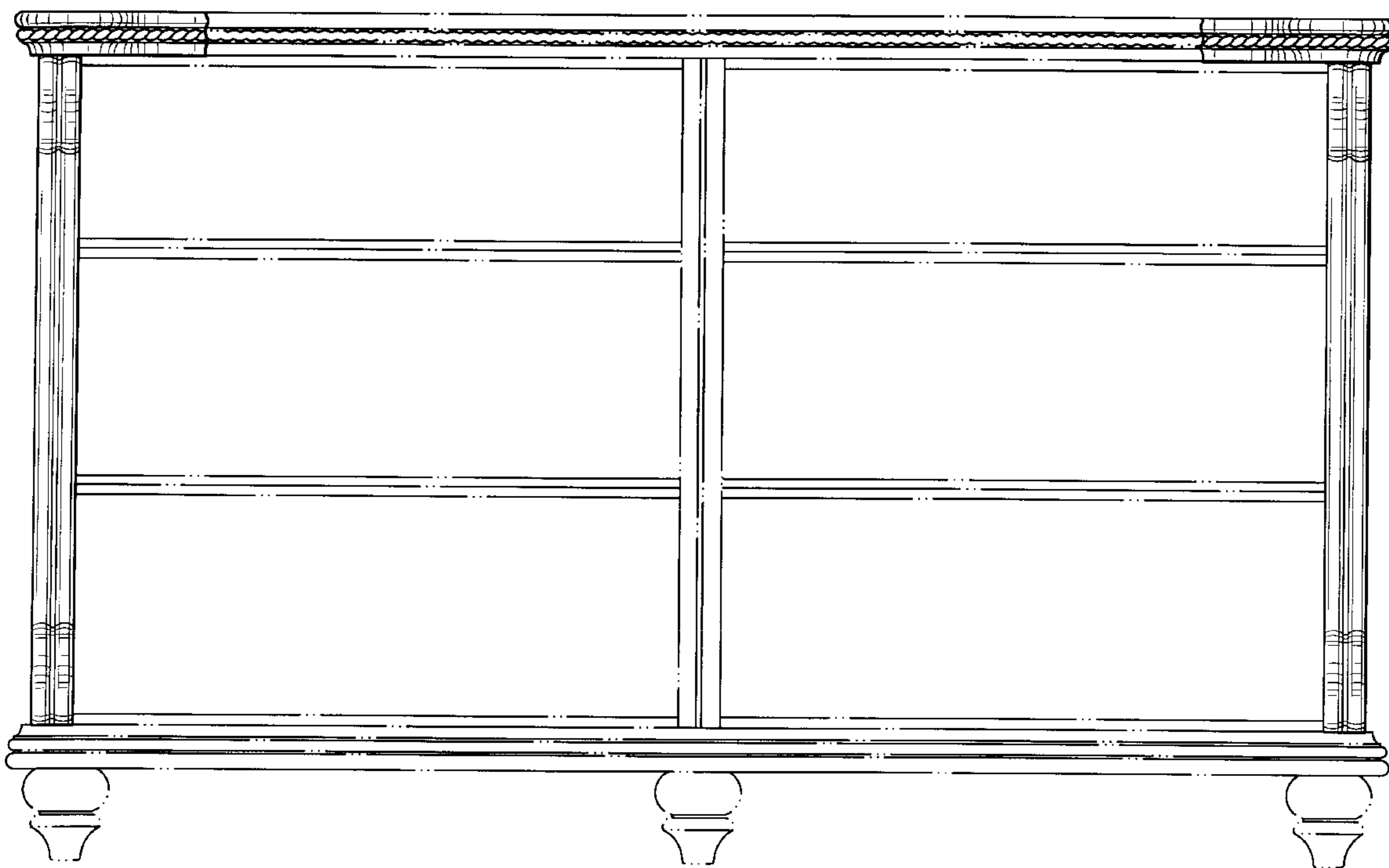

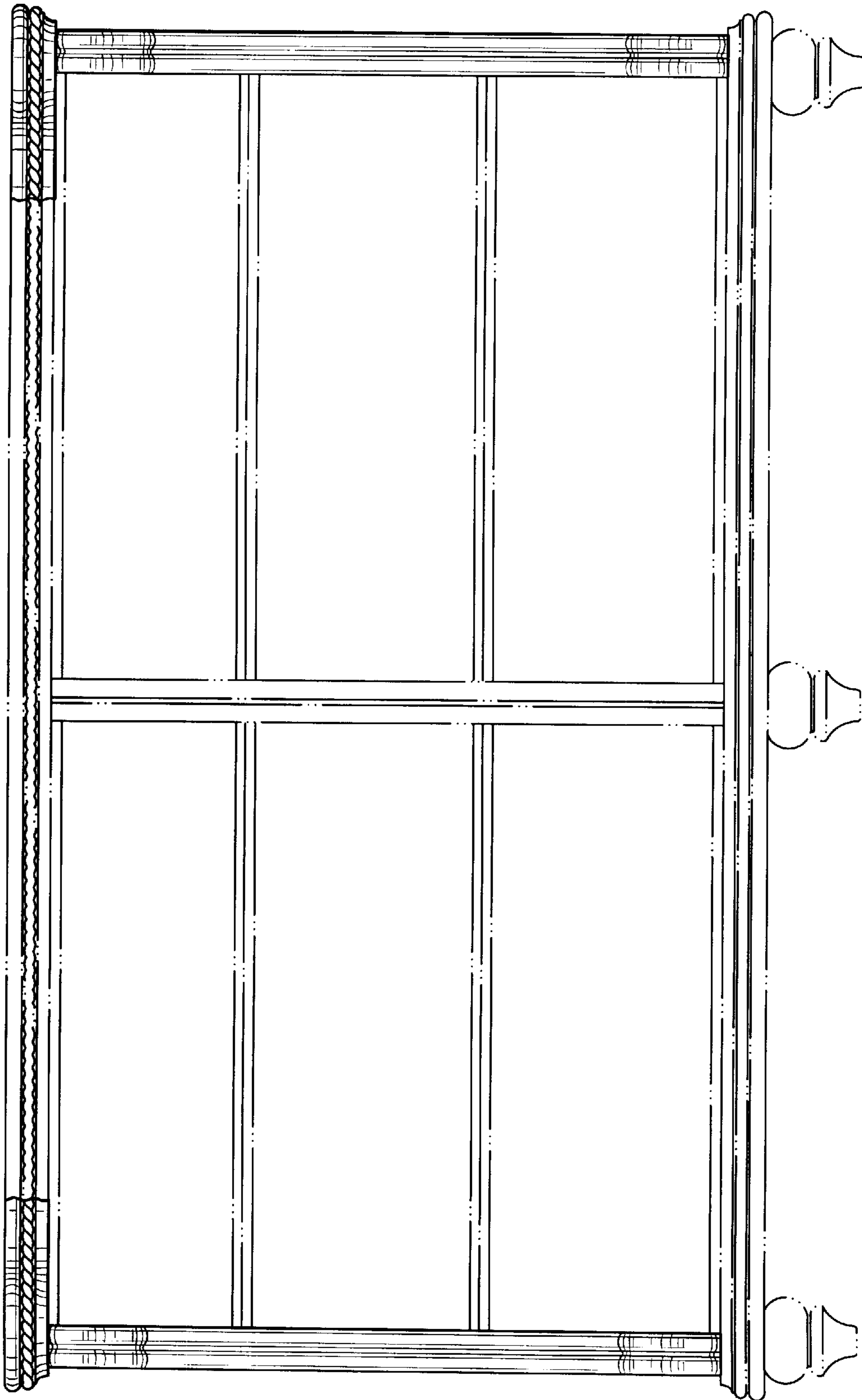

FIG. 1

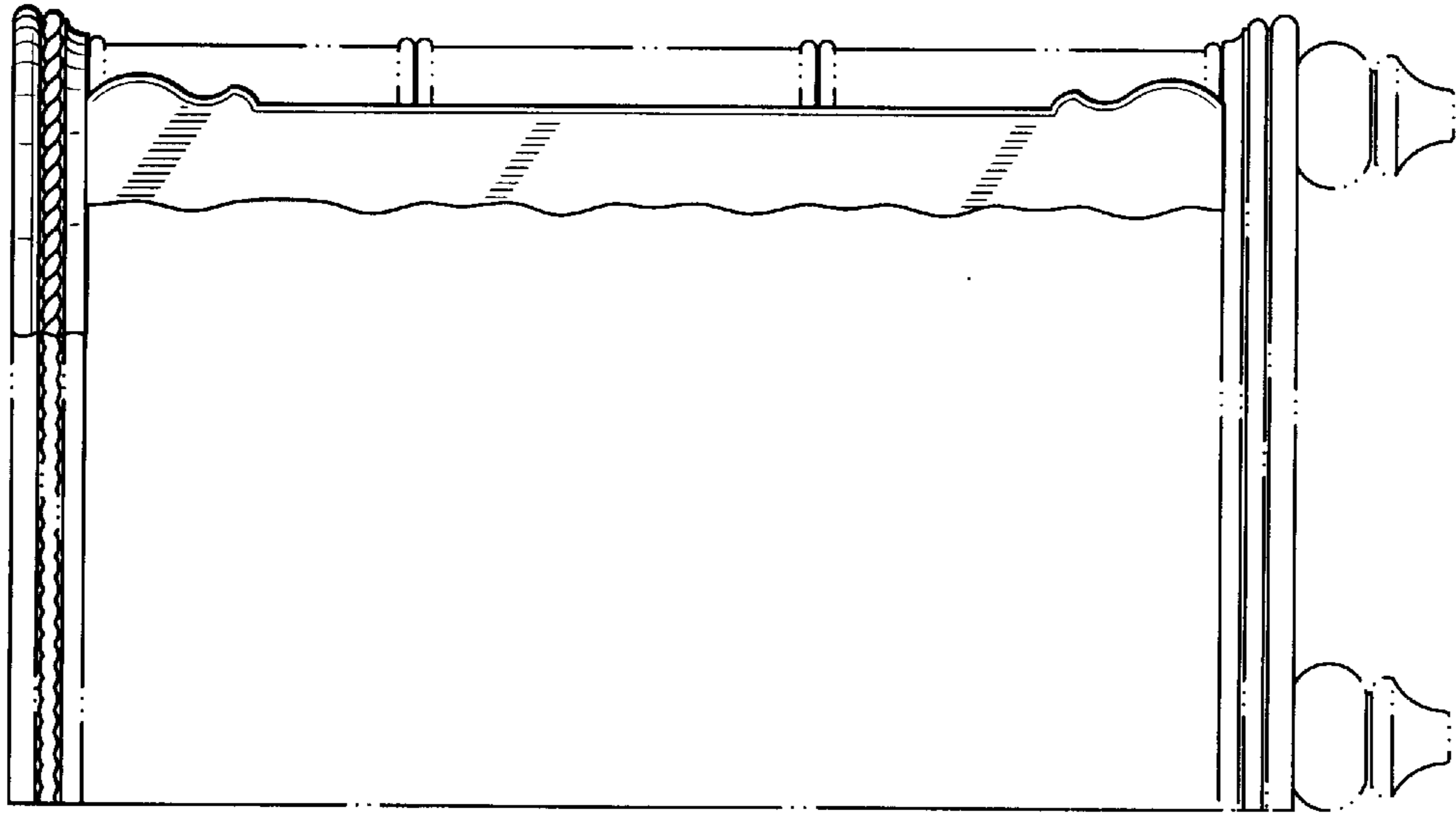

FIG. 4

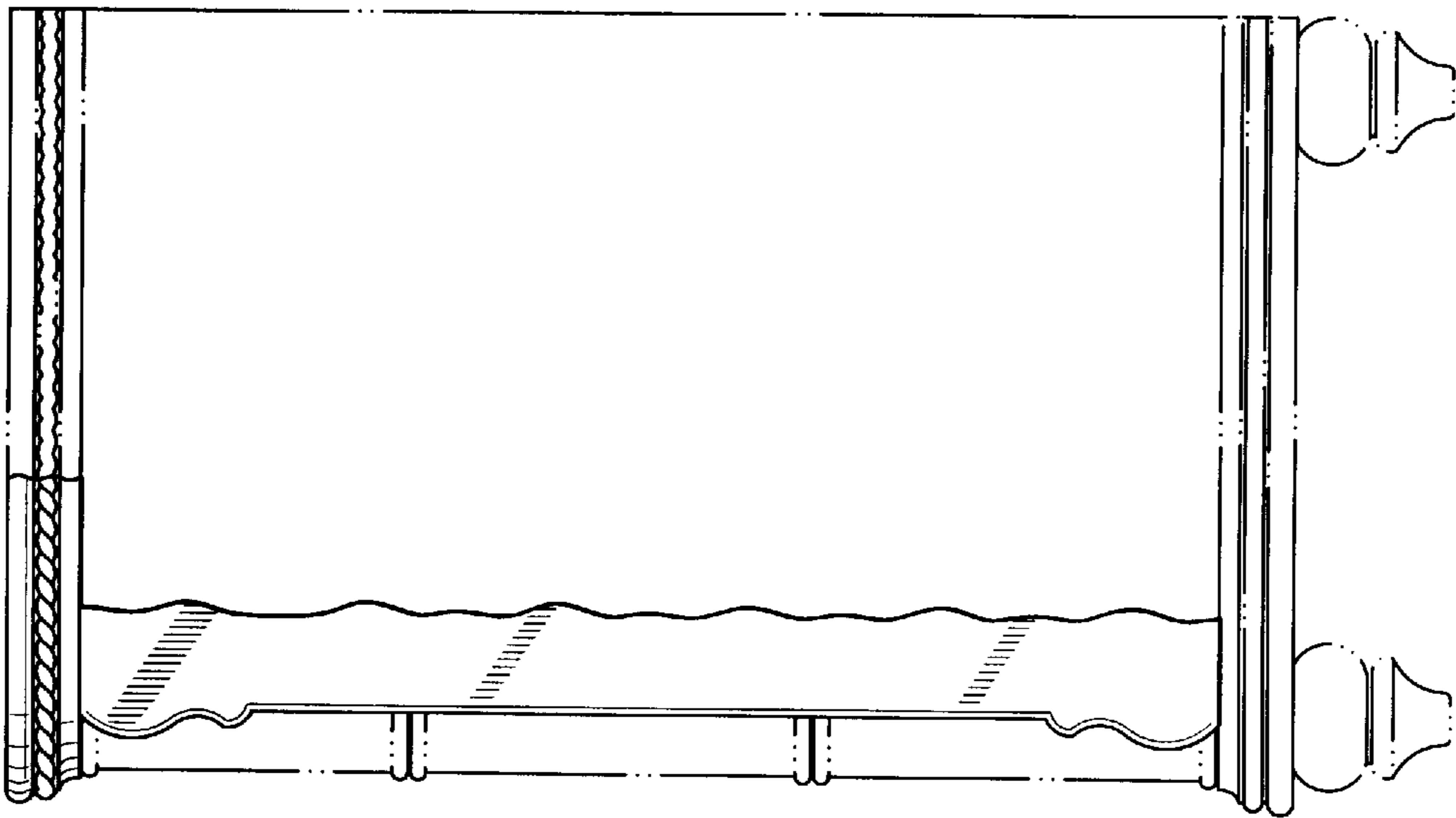

FIG. 2

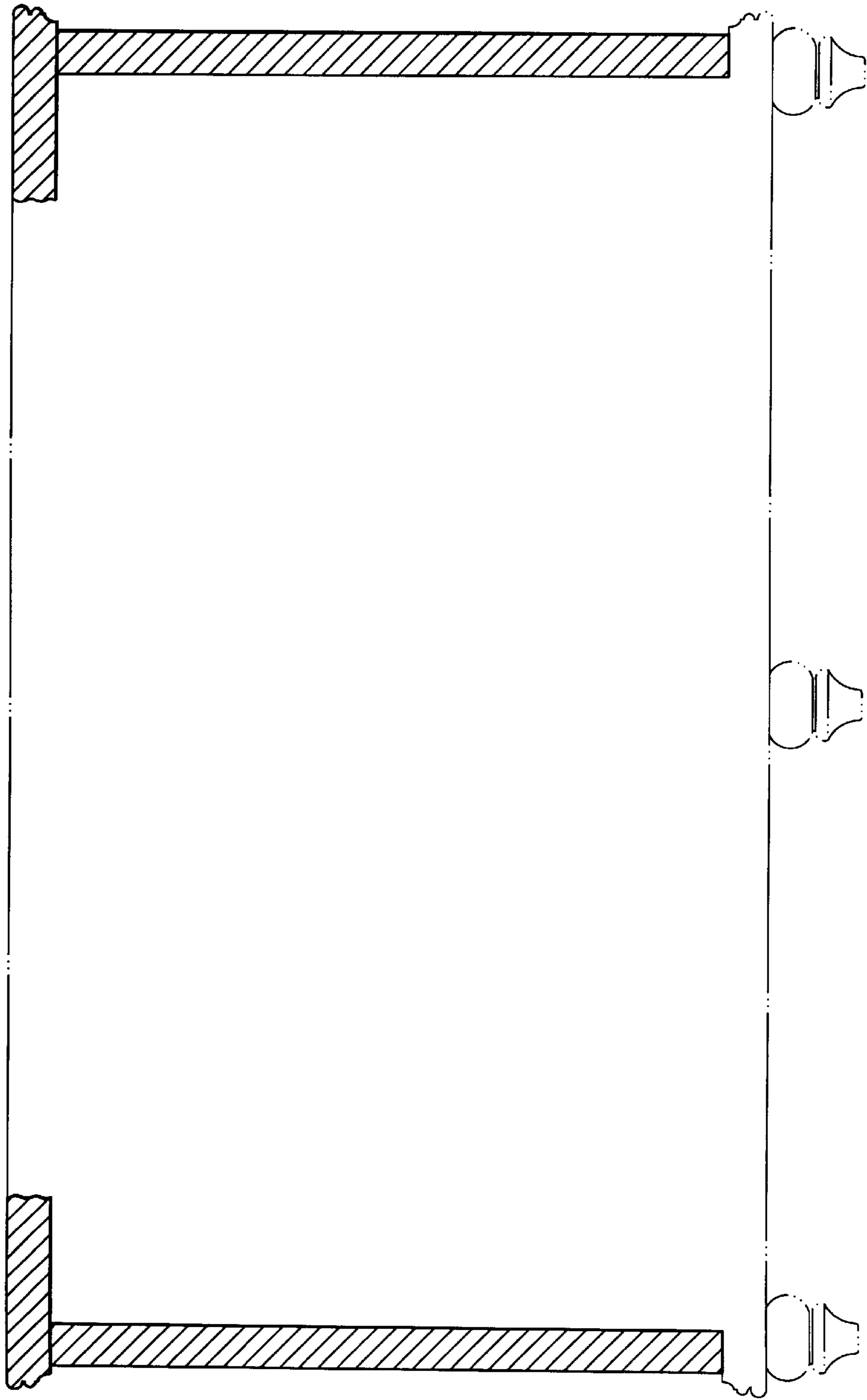

FIG. 3

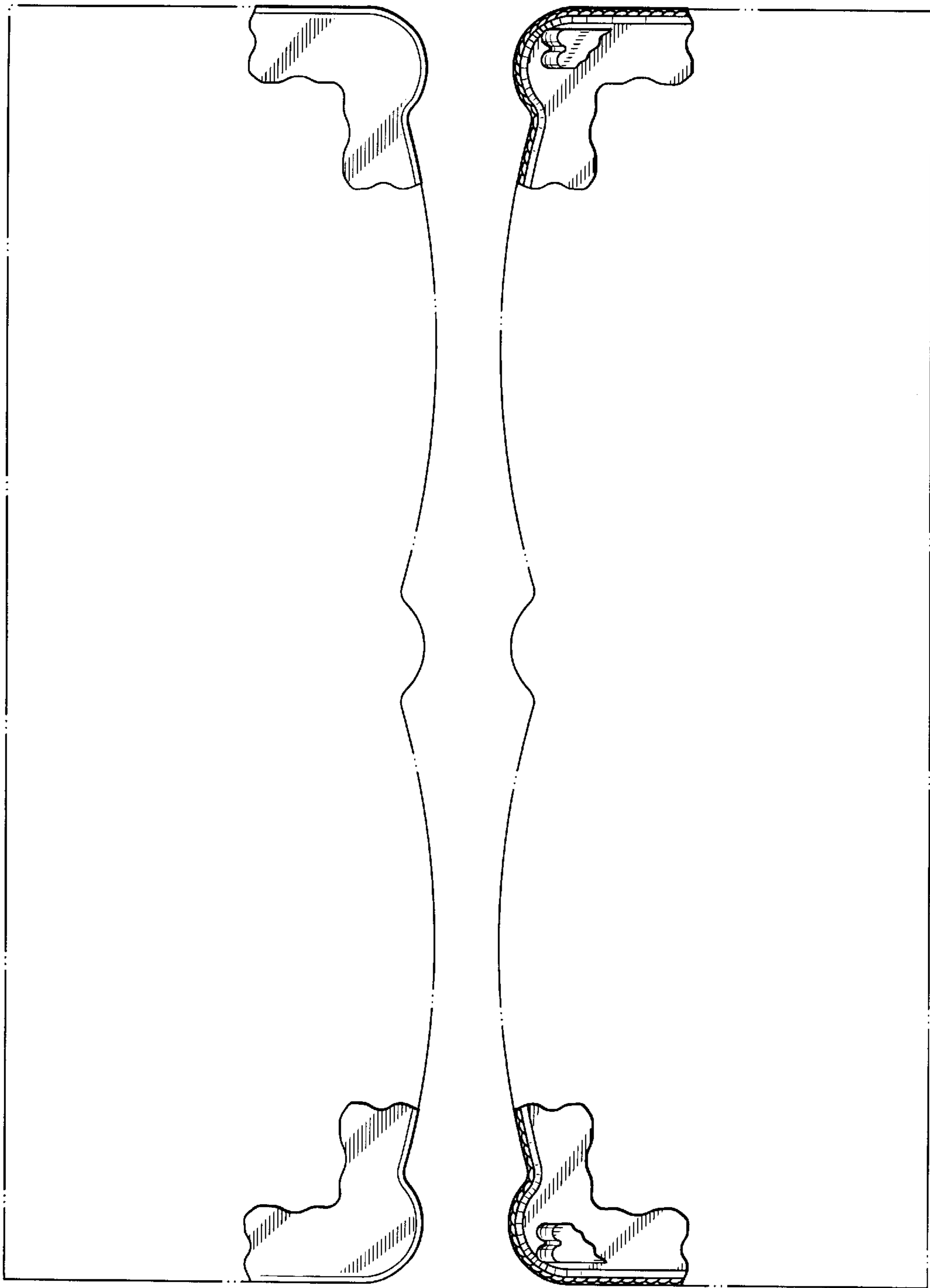

FIG. 5

FIG. 6

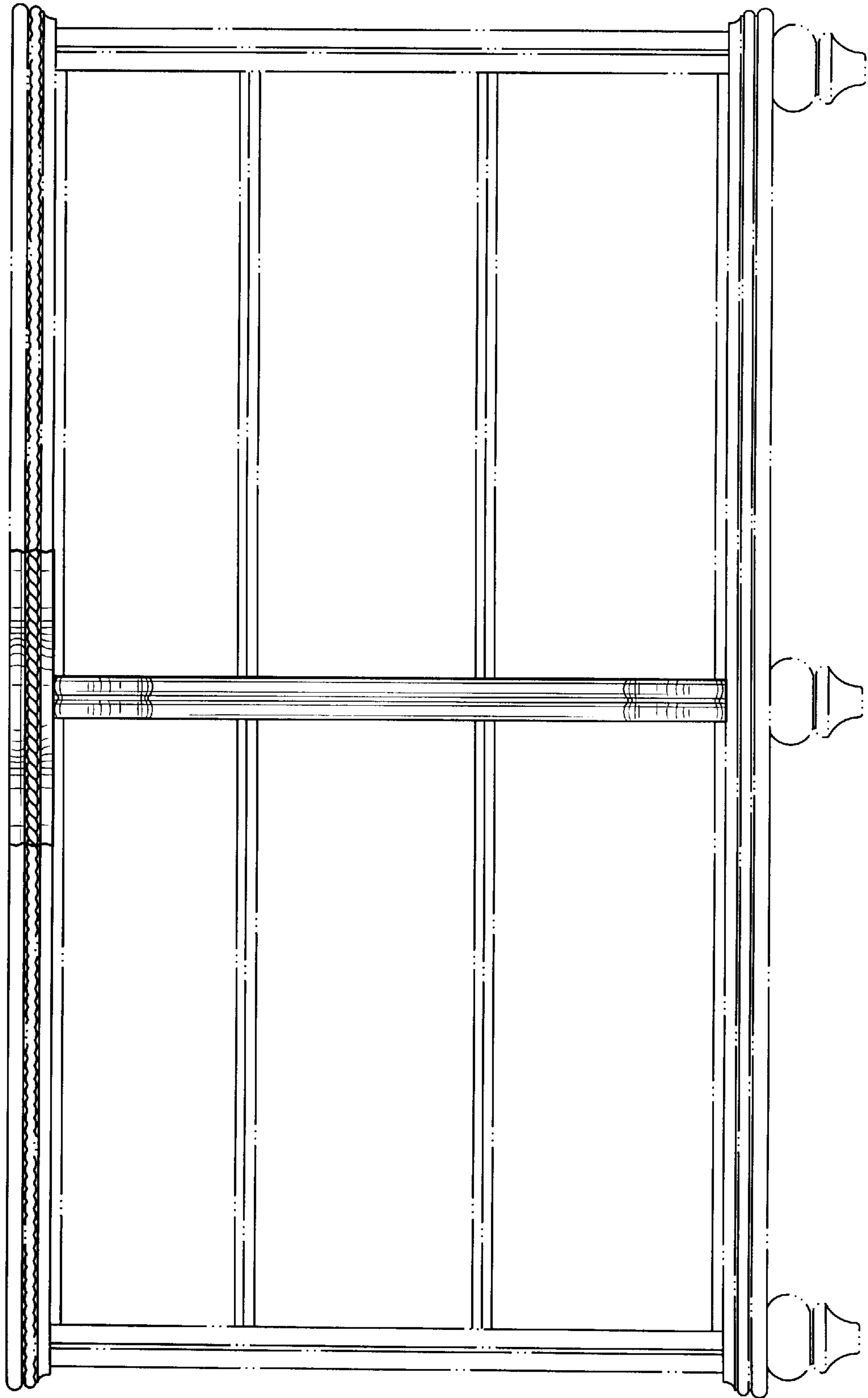

FIG. 7

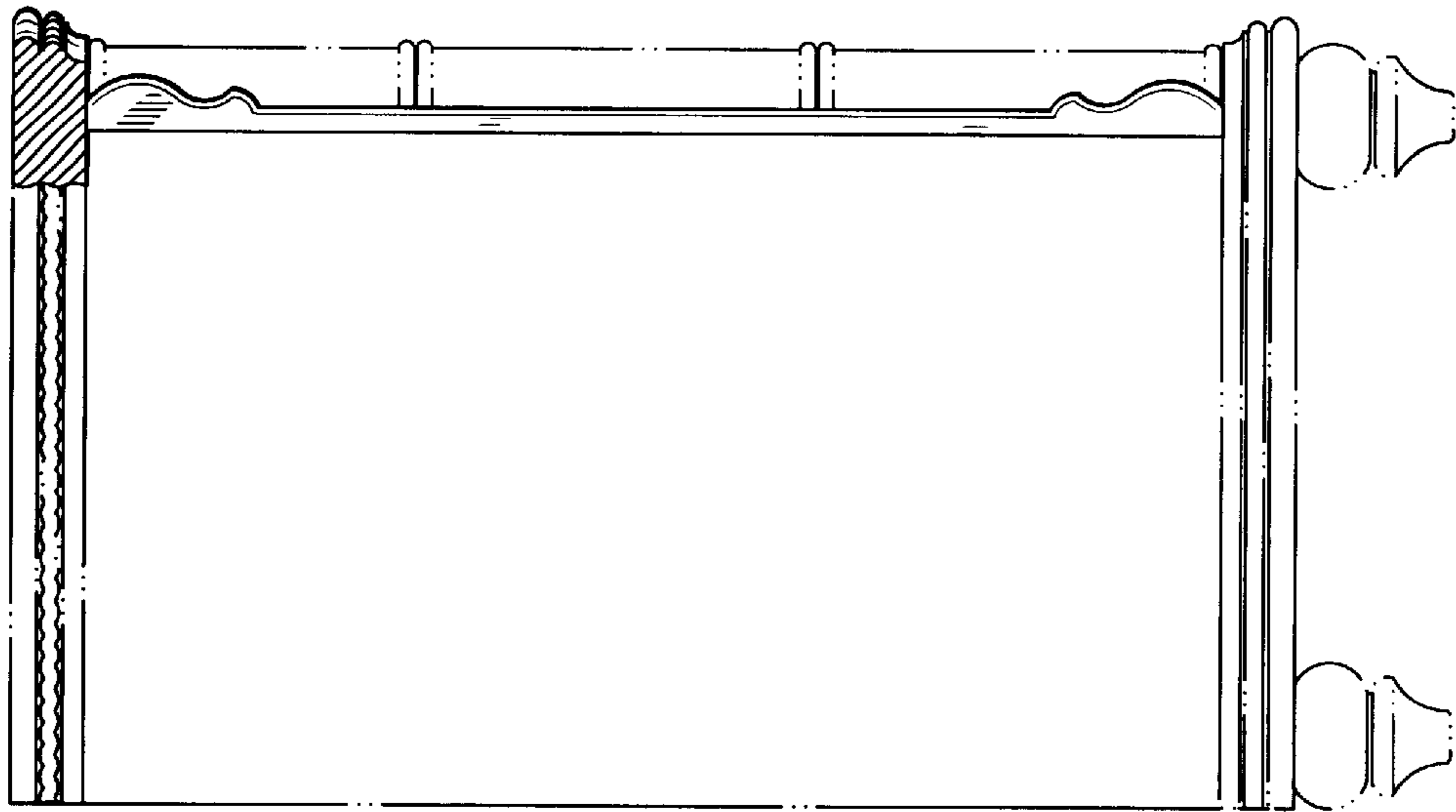

FIG. 10

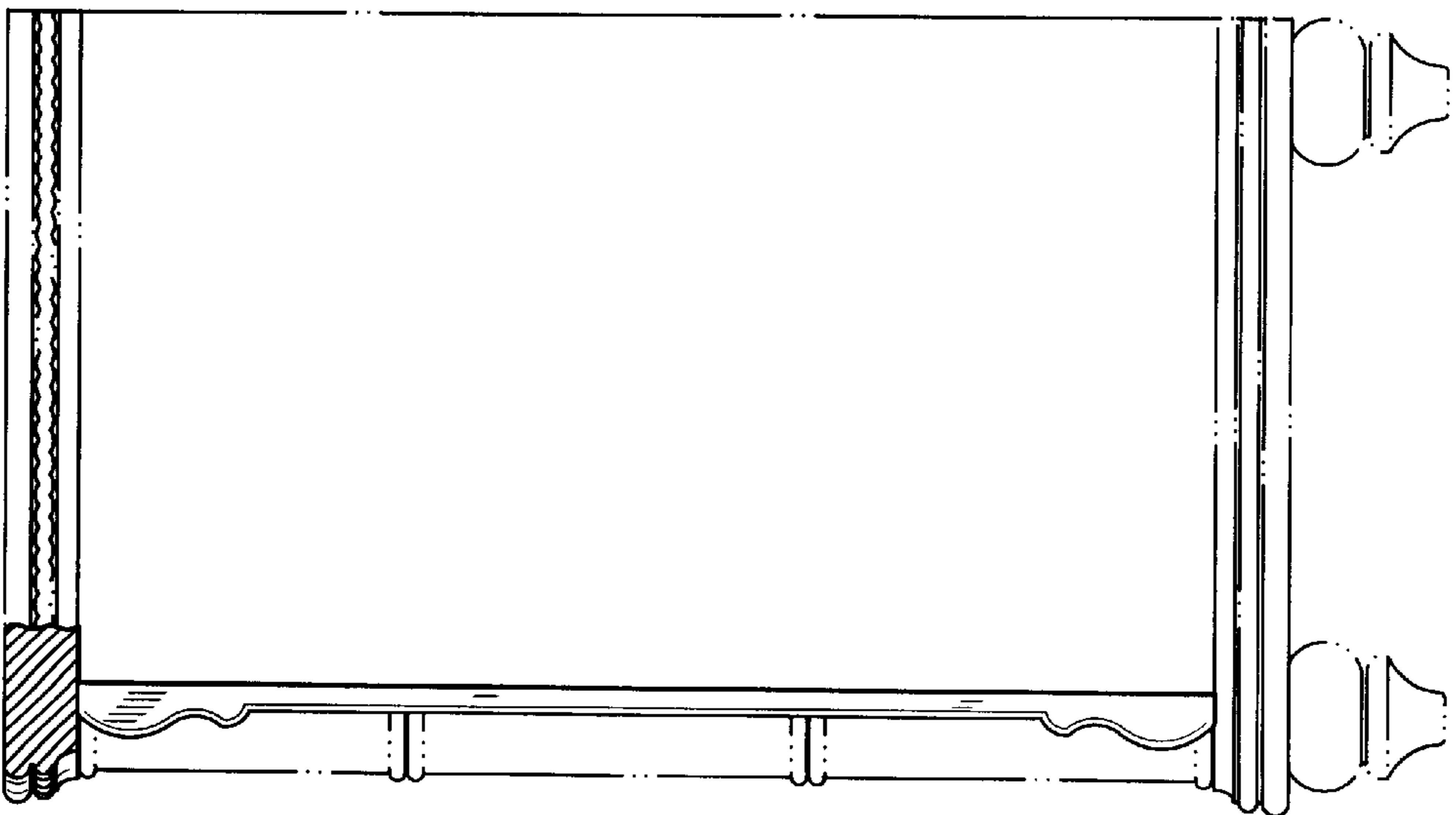

FIG. 8

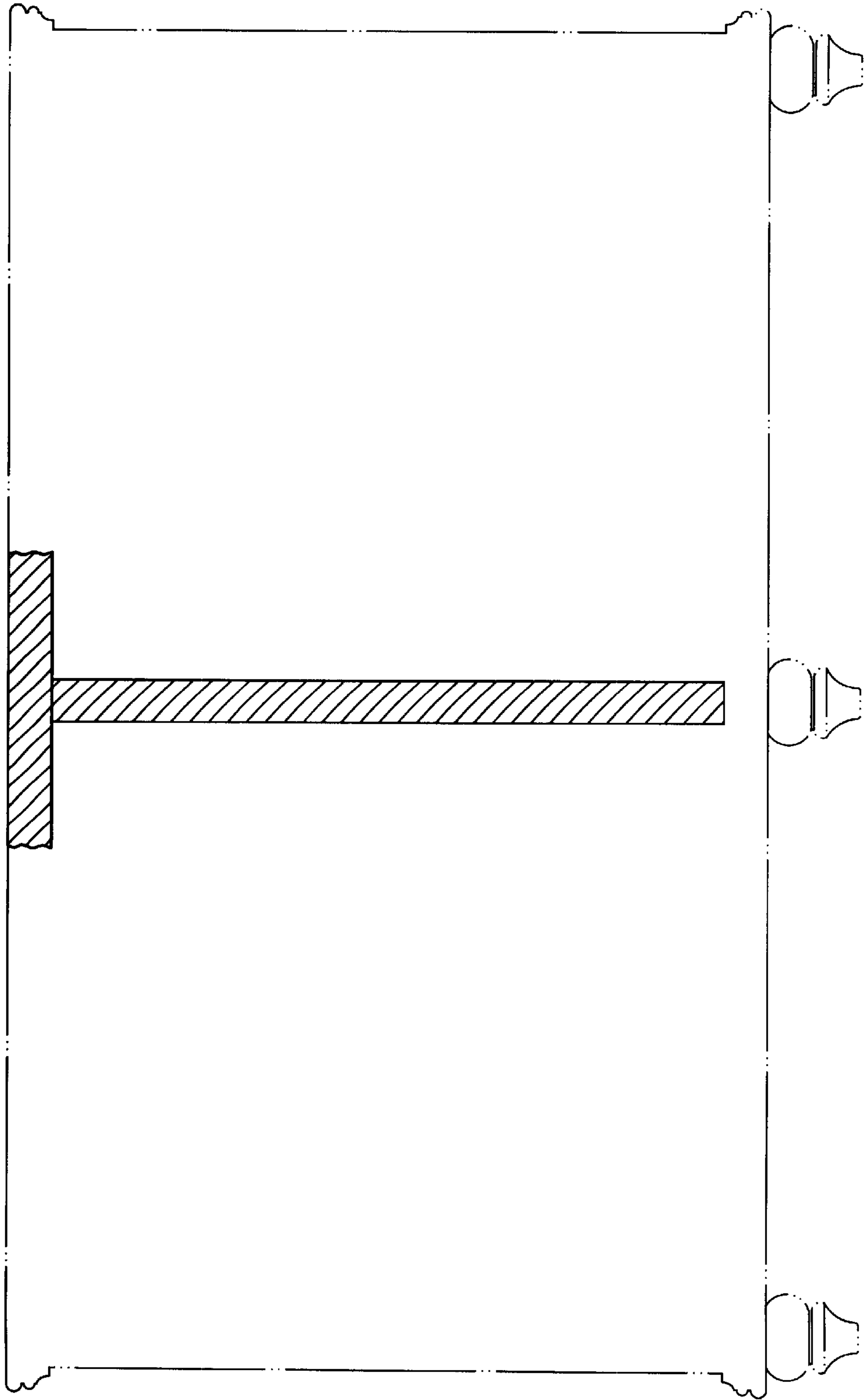

FIG. 9

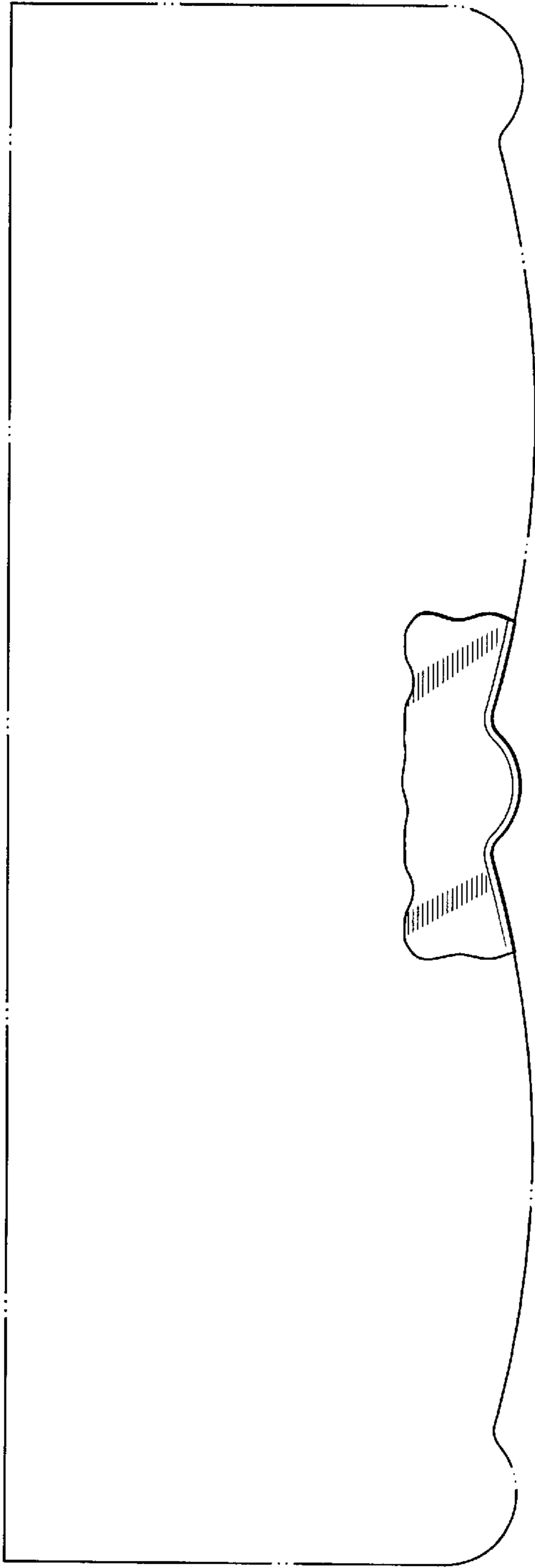

FIG. 11

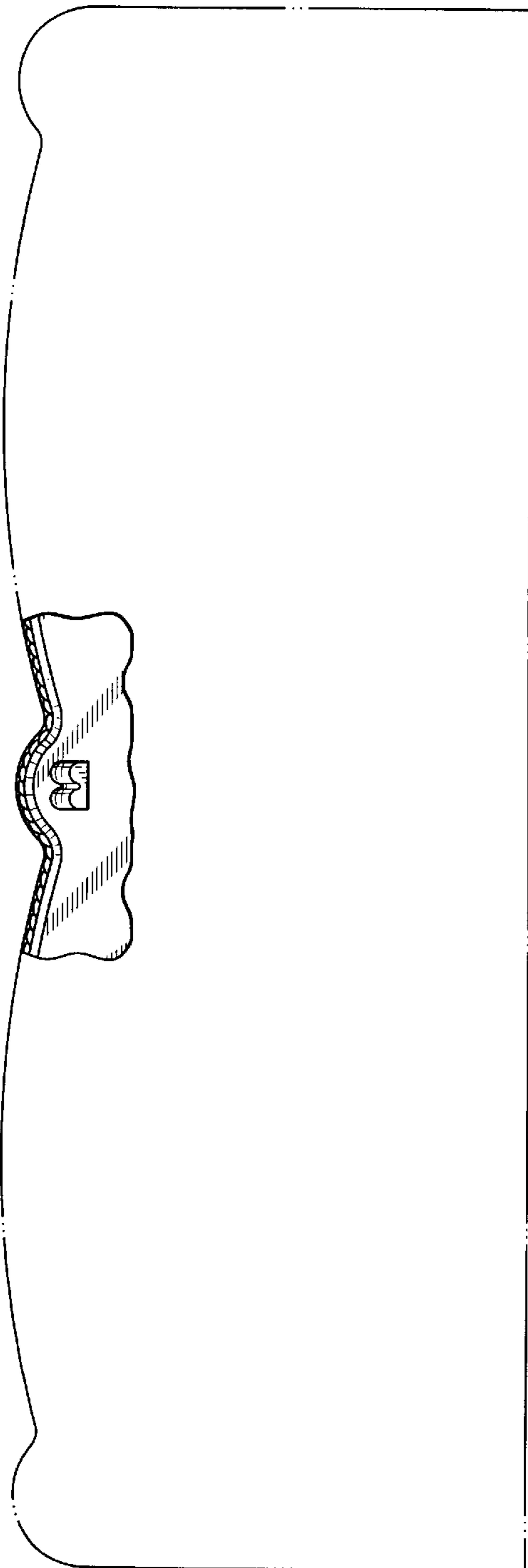

FIG. 12