



US00D470938S

(12) **United States Design Patent**
Howell et al.

(10) **Patent No.: US D470,938 S**

(45) **Date of Patent: ** Feb. 25, 2003**

(54) **DISPOSABLE SCALPEL**

(75) Inventors: **Glade Harold Howell**, Sandy, UT (US); **Simon Cohn**, North Arlington, NJ (US); **Charles Hwang**, Ridgewood, NJ (US); **John R. Montgomery**, Stanford, KY (US); **Paul DiCesare**, Easton, CT (US)

(73) Assignee: **Becton Dickinson and Company**, Franklin Lakes, NJ (US)

(**) Term: **14 Years**

(21) Appl. No.: **29/156,377**

(22) Filed: **Feb. 28, 2002**

Related U.S. Application Data

(63) Continuation-in-part of application No. 09/820,571, filed on Mar. 29, 2001.

(51) **LOC (7) Cl.** **24-02**

(52) **U.S. Cl.** **D24/147**

(58) **Field of Search** D29/146, 147, D29/133; 606/167, 172, 166, 181, 182; 30/335, 162; D8/99

(56) **References Cited**

U.S. PATENT DOCUMENTS

3,748,736	A	*	7/1973	Eisen	D24/146
3,906,626	A	*	9/1975	Riuli	30/335
4,798,000	A	*	1/1989	Bedner et al.	606/167
5,250,063	A	*	10/1993	Abidin et al.	606/167
5,299,357	A	*	4/1994	Wonderley et al.	30/335
5,417,704	A	*	5/1995	Wonderley	30/335
5,868,771	A	*	2/1999	Herbert et al.	30/162
5,938,676	A	*	8/1999	Cohn et al.	606/167

* cited by examiner

Primary Examiner—Ian Simmons

(74) *Attorney, Agent, or Firm*—James J. Murtha

(57) **CLAIM**

The ornamental design of a disposable scalpel, as shown and described.

DESCRIPTION

FIG. 1 is a perspective view from a left, proximal end of the scalpel in a shielded position;
 FIG. 2 is a perspective view from a right, proximal end of the scalpel of FIG. 1 in a shielded position;
 FIG. 3 is a top elevation view of the scalpel of FIG. 1 in a shielded position;
 FIG. 4 is a right side elevation view of the scalpel of FIG. 1 in a shielded position;
 FIG. 5 is a left side elevation view of the scalpel of FIG. 1 in a shielded position;
 FIG. 6 is a bottom elevation view of the scalpel of FIG. 1 in a shielded position;
 FIG. 7 is an end elevation view of the scalpel of FIG. 1 as viewed from the left of FIG. 4 (shown in twice the scale of FIG. 1 for clarity's sake) in a shielded position;
 FIG. 8 is an end elevation view of the scalpel of FIG. 1 as viewed from the right of FIG. 4 (shown in twice the scale of FIG. 1 for clarity's sake) in a shielded position;
 FIG. 9 is a perspective view from a left, proximal end of the scalpel in a unshielded position;
 FIG. 10 is a perspective view from a right, proximal end of the scalpel of FIG. 1 in a unshielded position;
 FIG. 11 is a top elevation view of the scalpel of FIG. 1 in a unshielded position;
 FIG. 12 is a right side elevation view of the scalpel of FIG. 1 in an unshielded position;
 FIG. 13 is a left side elevation view of the scalpel of FIG. 1 in an unshielded position;
 FIG. 14 is a bottom elevation view of the scalpel of FIG. 1 in an unshielded position;
 FIG. 15 is an elevation view of the scalpel of FIG. 1 as viewed from the left of FIG. 4 (shown in twice the scale of FIG. 1 for clarity's sake) in an unshielded position; and,
 FIG. 16 is an end elevation view of the scalpel of FIG. 1 as viewed from the right of FIG. 4 (shown in twice the scale of FIG. 1 for clarity's sake) in an unshielded position.
 The broken line showing in FIGS. 9 through 14 of the scalpel blade is for illustrative purposes only and forms no part of the claimed design.

1 Claim, 10 Drawing Sheets

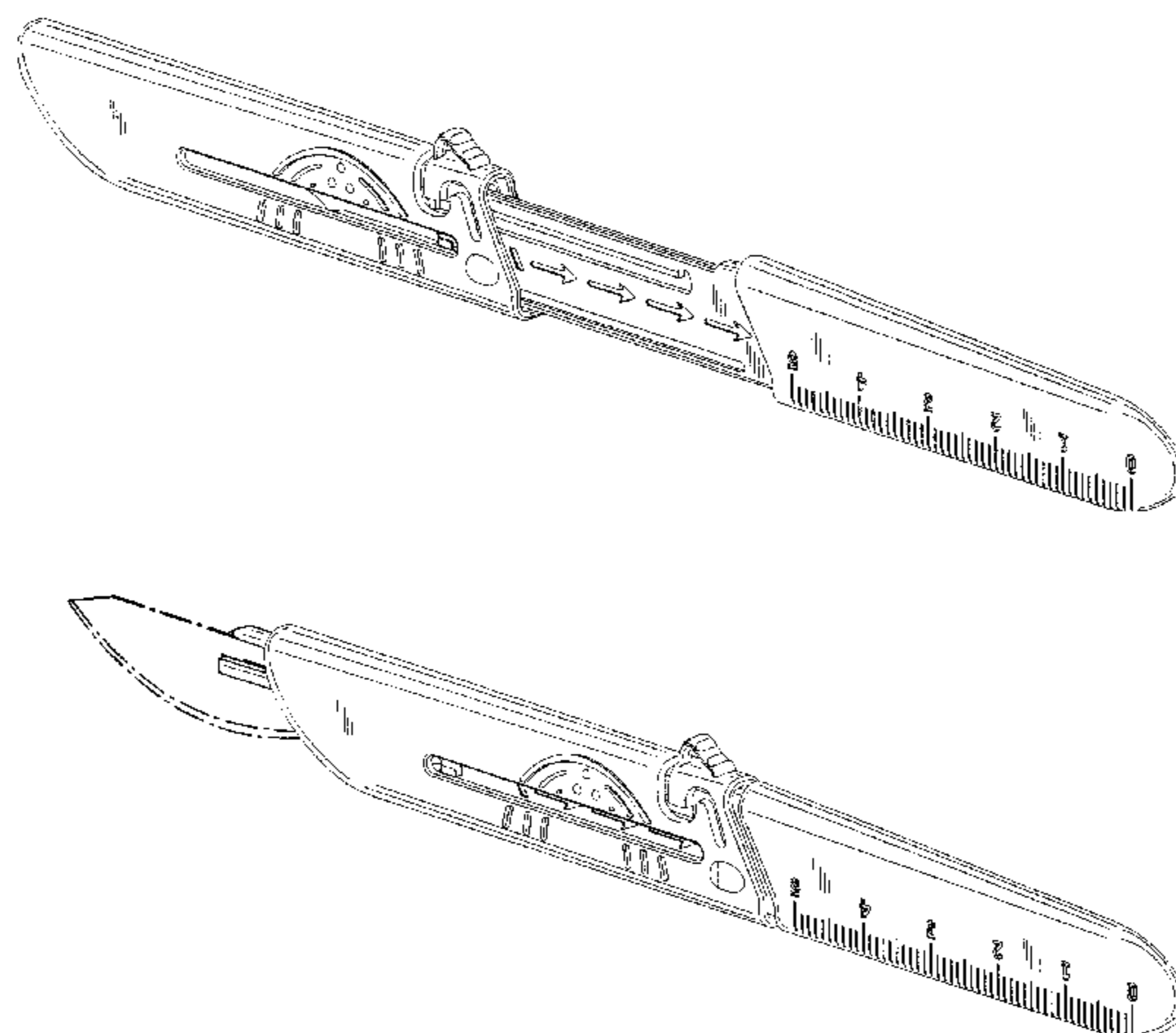
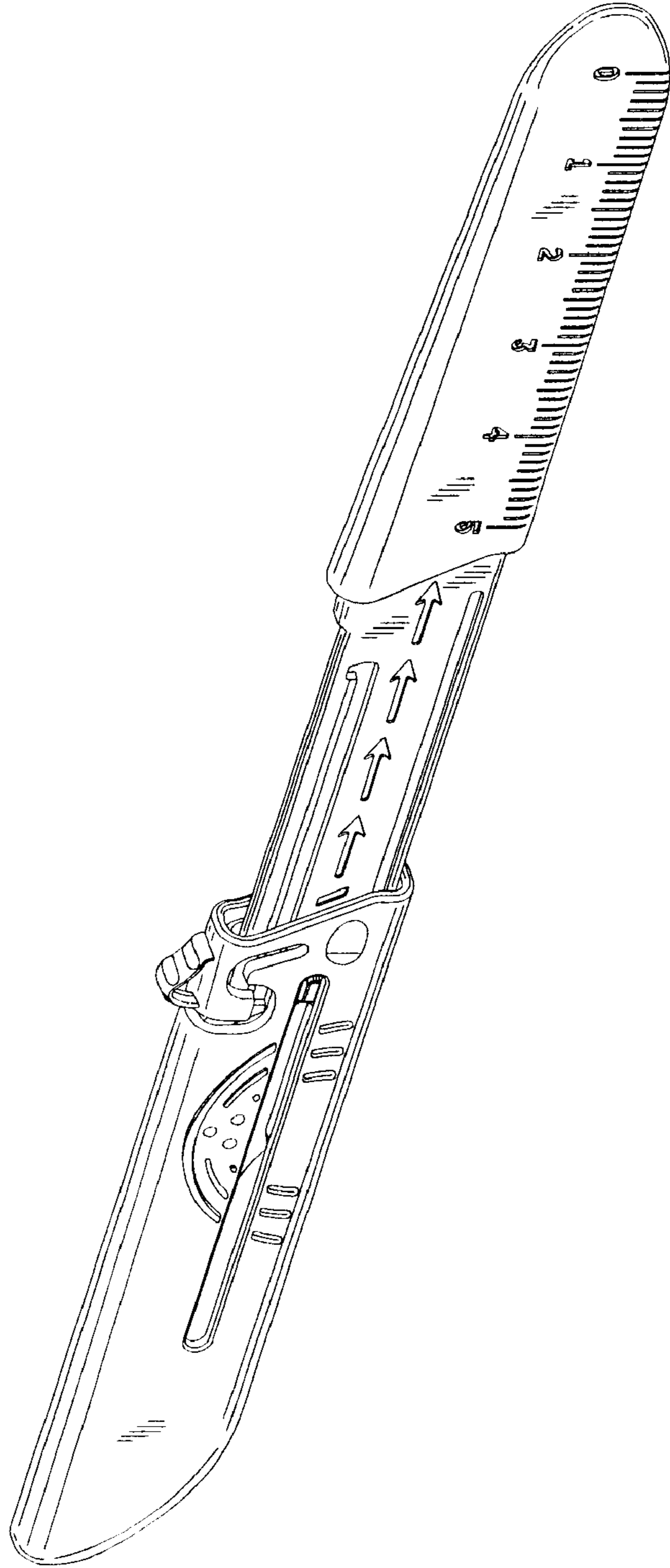

FIG. 1



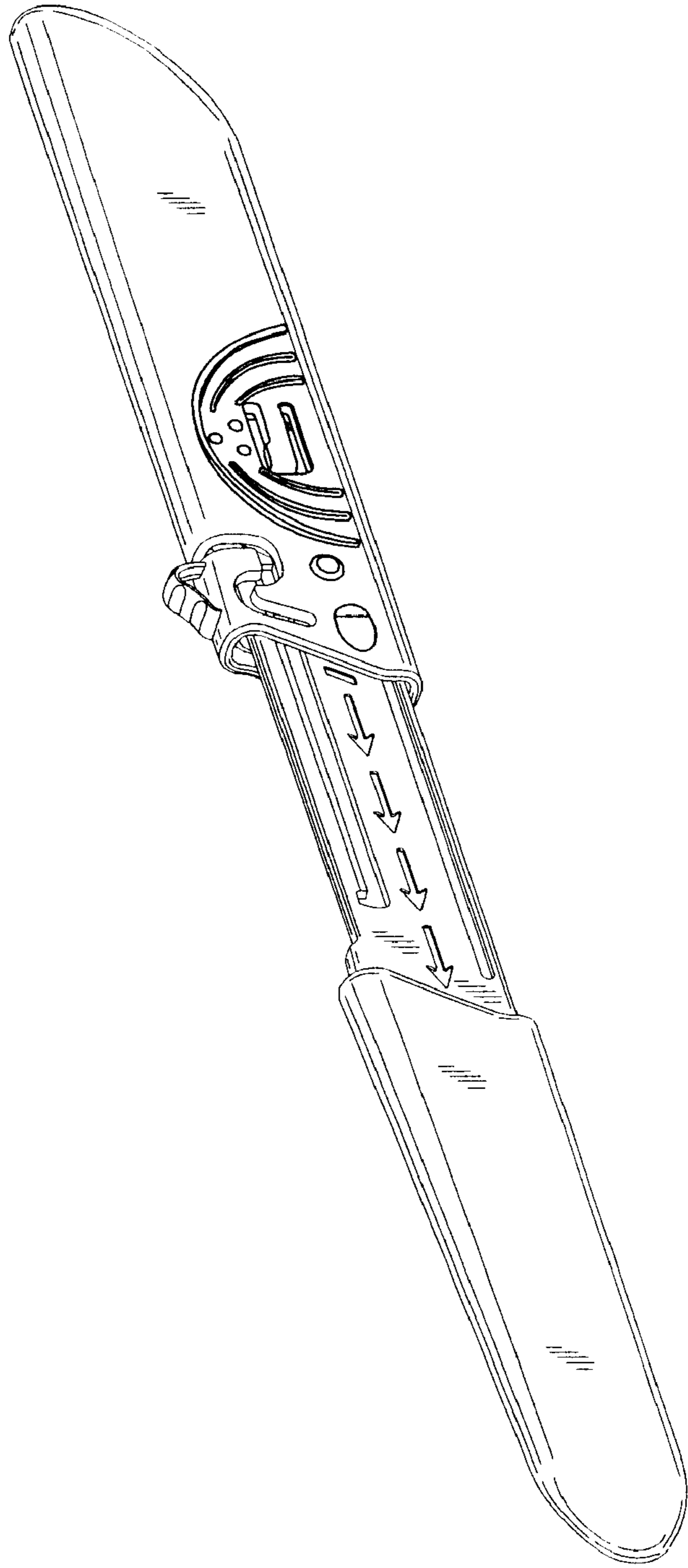

FIG. 2

FIG. 3

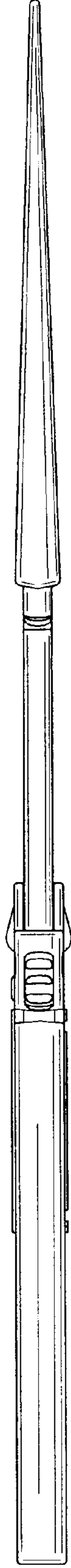

FIG. 4

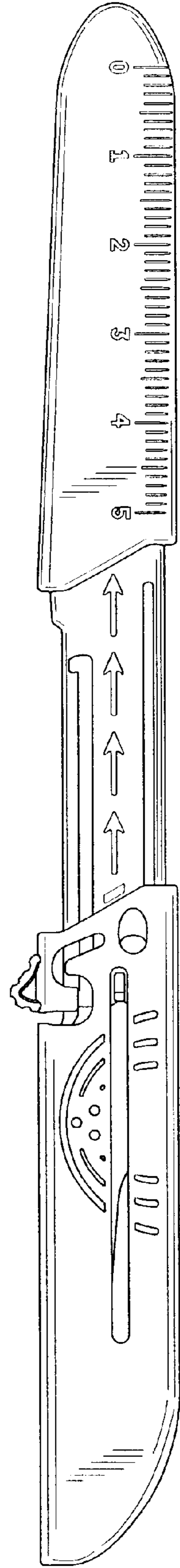

FIG. 5

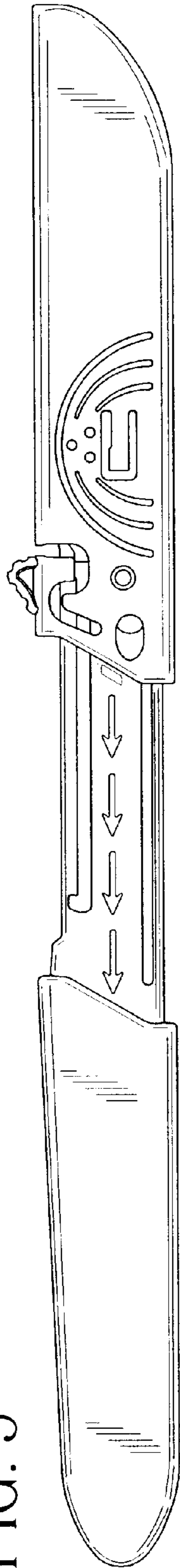

FIG. 6

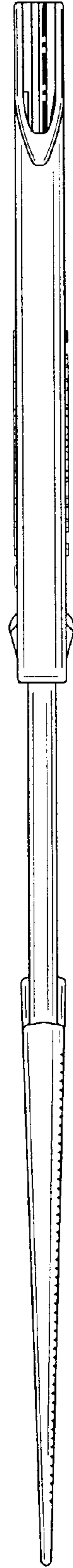

FIG. 7

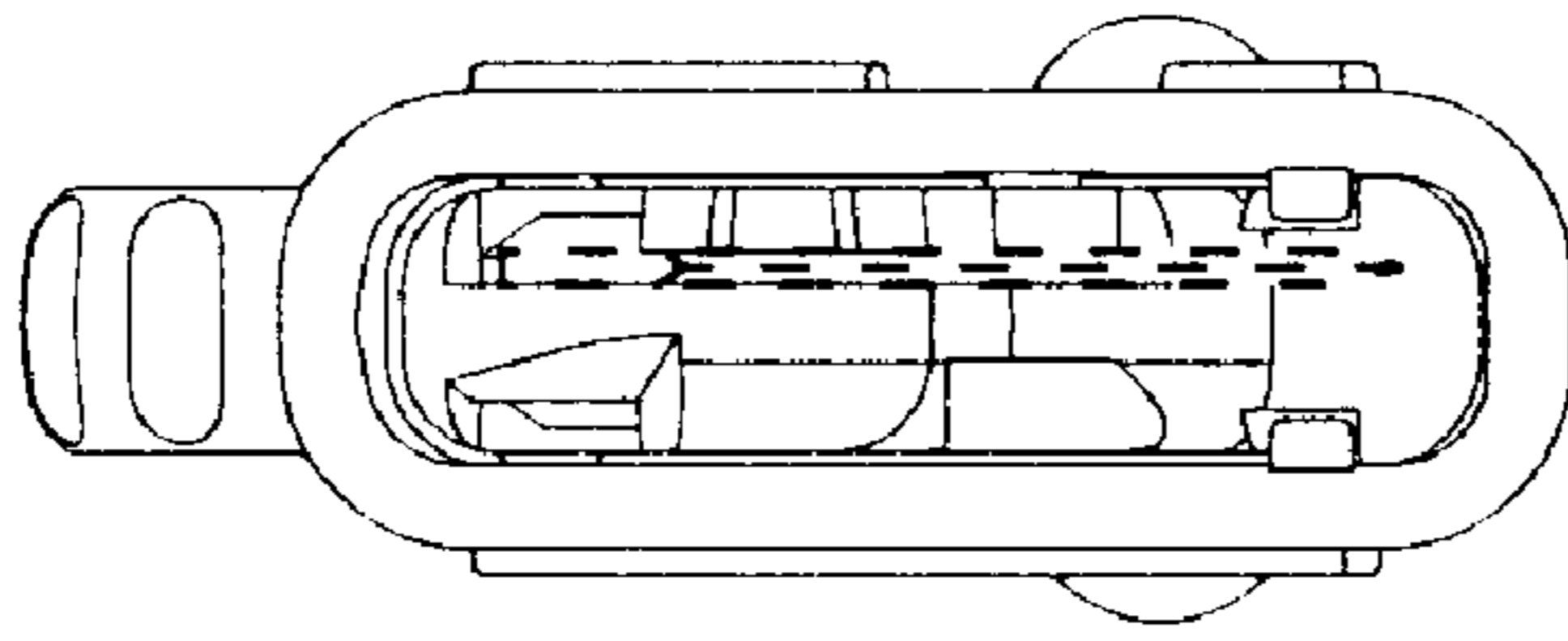
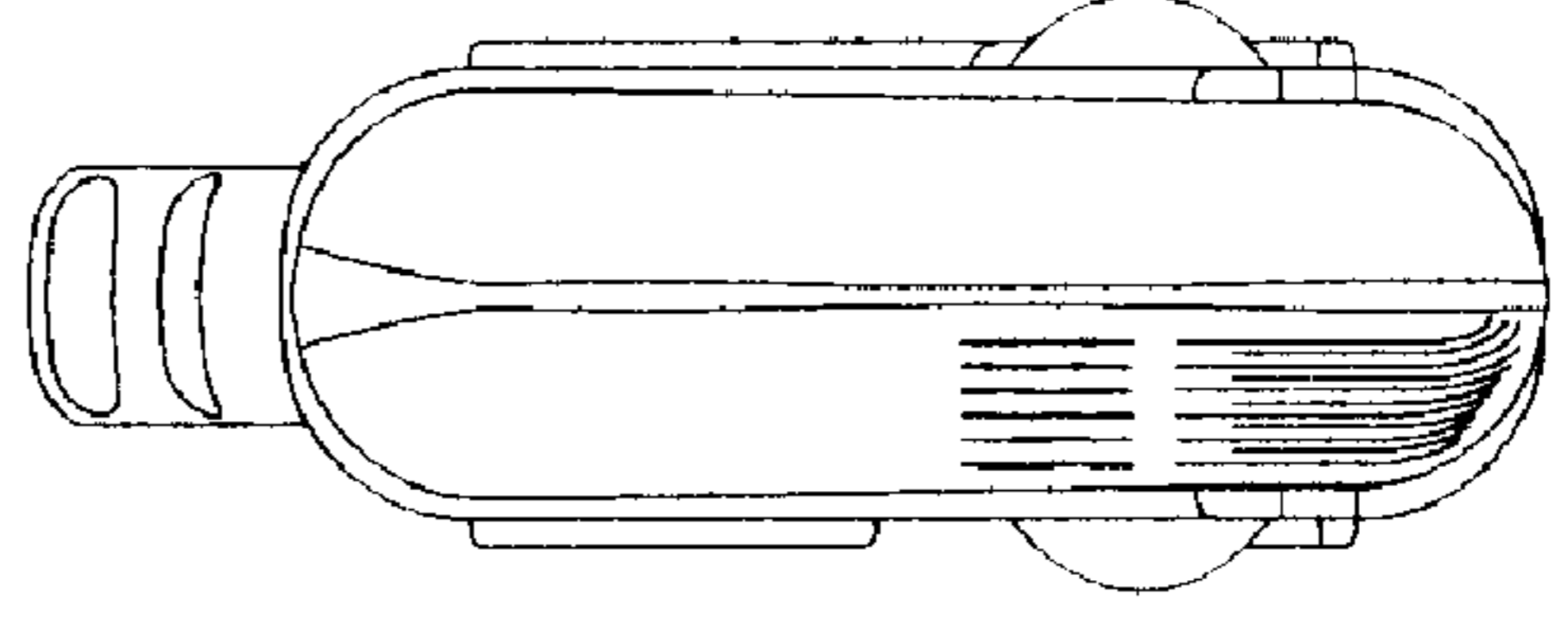

FIG. 8



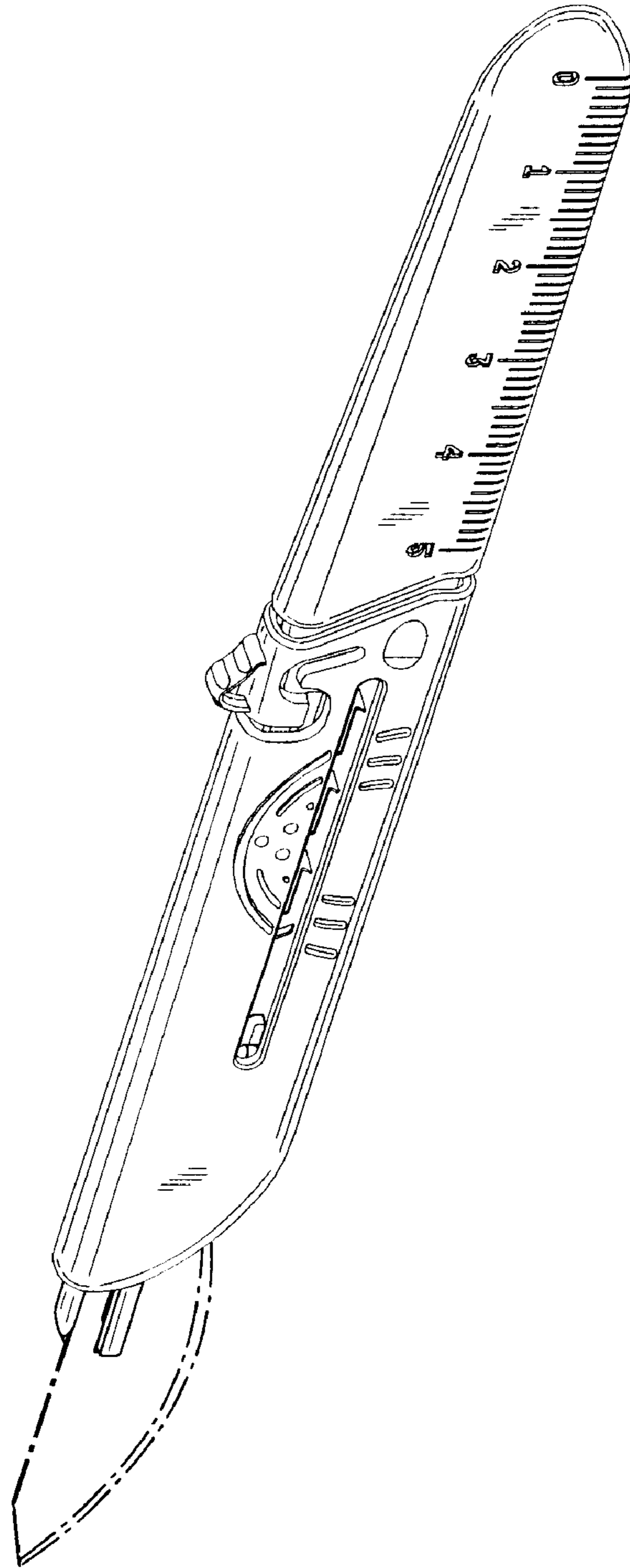

FIG. 9

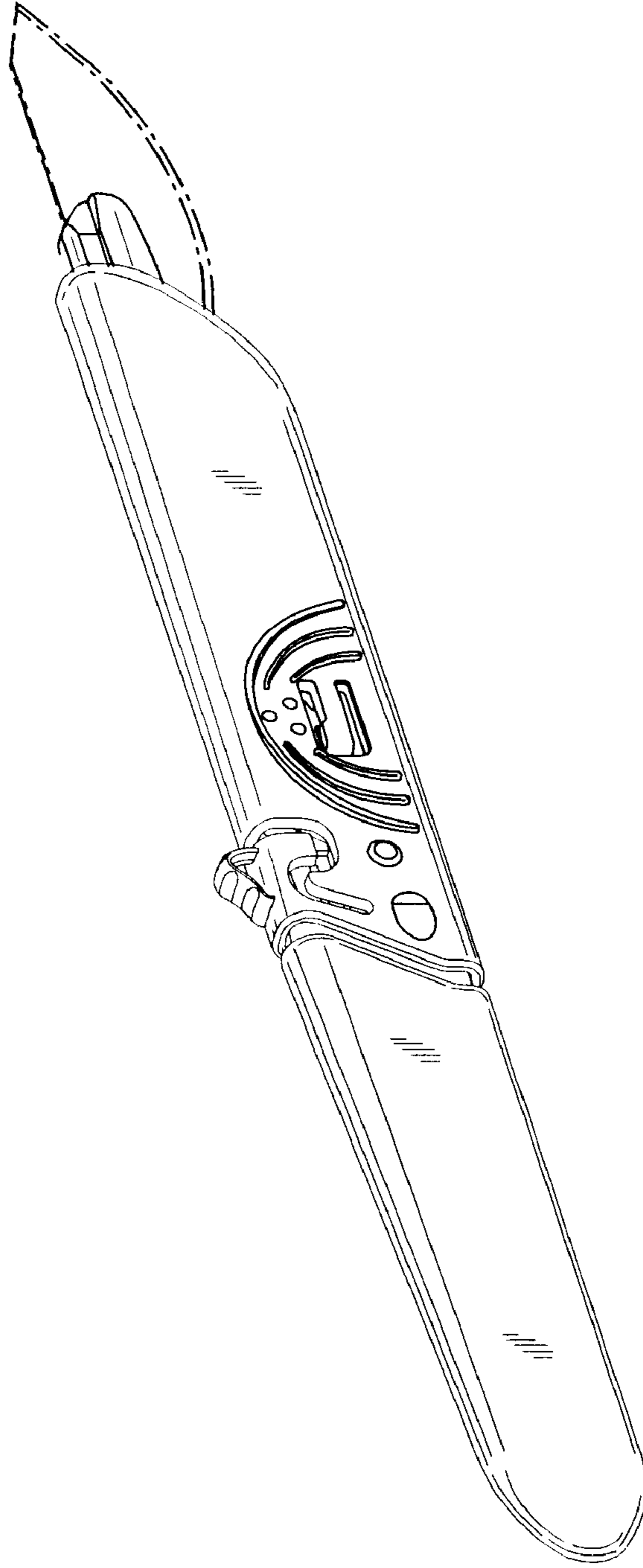

FIG. 10

FIG. 11

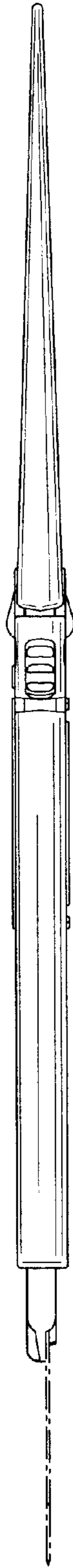

FIG. 12

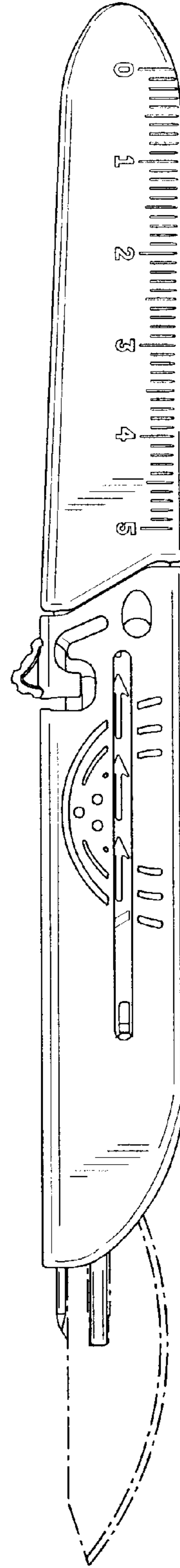

FIG. 13

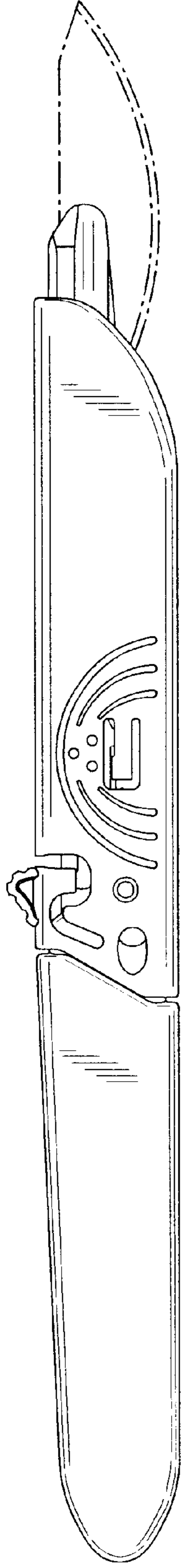

FIG. 14

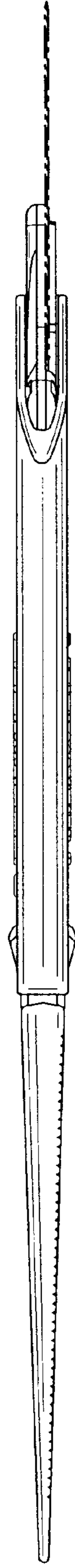

FIG. 15

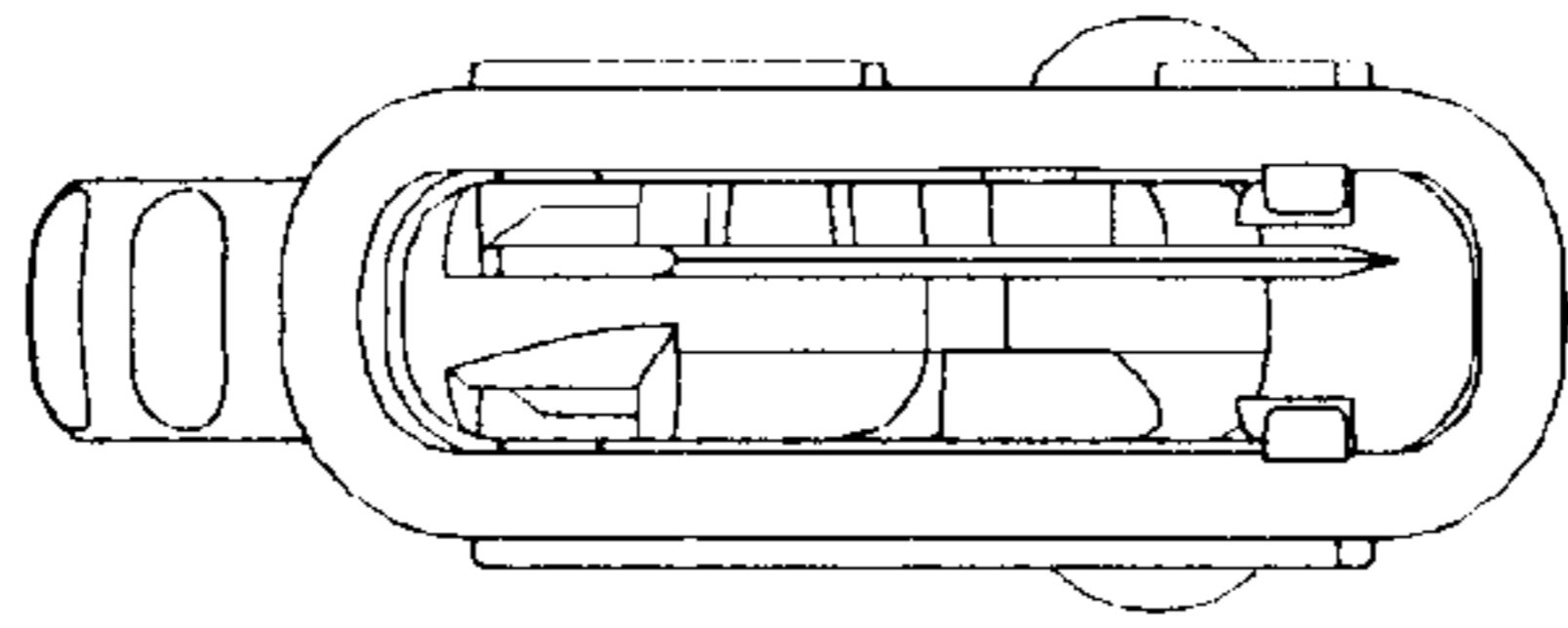

FIG. 16

