



US00D470849S

(12) **United States Design Patent**  
**Bertagnole et al.**

(10) **Patent No.:** **US D470,849 S**

(45) **Date of Patent:** **\*\* Feb. 25, 2003**

(54) **DOCKING STATION**

(75) Inventors: **Shawn R. Bertagnole**, Lake Stevens, WA (US); **Rodney Merry**, Woodinville, WA (US); **Neil McIlvaine**, Seattle, WA (US)

(73) Assignee: **Medtronic Physio-Control Corp.**, Redmond, WA (US)

(\*\*) Term: **14 Years**

(21) Appl. No.: **29/153,464**

(22) Filed: **Jan. 4, 2002**

(51) **LOC (7) Cl.** ..... **14-02**

(52) **U.S. Cl.** ..... **D14/434**

(58) **Field of Search** ..... D14/432-434, D14/439-447, 300, 356, 357; D13/184, 199; 361/679-687; 200/5 R, 5 A, 6 R, 6 A

(56) **References Cited**

**U.S. PATENT DOCUMENTS**

5,248,264 A	9/1993	Long et al.	
D345,969 S	* 4/1994	McKnight et al.	D14/451
D350,536 S	* 9/1994	McKnight et al.	D14/447
5,375,604 A	12/1994	Kelly et al.	
D363,276 S	* 10/1995	Lucente et al.	D14/434
D363,722 S	* 10/1995	Aldridge et al.	D14/242
5,488,537 A	1/1996	Heald et al.	
D380,446 S	* 7/1997	Chou	D13/162.1
5,829,997 A	11/1998	Okano et al.	
5,876,351 A	3/1999	Rohde	
5,921,697 A	7/1999	Karl et al.	
D412,702 S	* 8/1999	Goto	D14/434

5,933,321 A	8/1999	Ruch et al.	
5,946,186 A	8/1999	Karl et al.	
5,957,838 A	9/1999	Rantala	
D416,547 S	* 11/1999	Lee et al.	D14/434
5,997,323 A	12/1999	Youn	
D421,424 S	* 3/2000	Lee et al.	D14/434
6,183,417 B1	2/2001	Geheb et al.	
6,185,095 B1	2/2001	Helot et al.	
6,221,012 B1	4/2001	Maschke et al.	
6,227,518 B1	5/2001	Sun	
6,280,212 B1	8/2001	Nguyen et al.	
6,310,766 B1	10/2001	Bae	
D457,163 S	* 5/2002	Peiker	D14/434

\* cited by examiner

*Primary Examiner*—Kay H. Chin

(74) *Attorney, Agent, or Firm*—Shumaker & Sieffert, PA

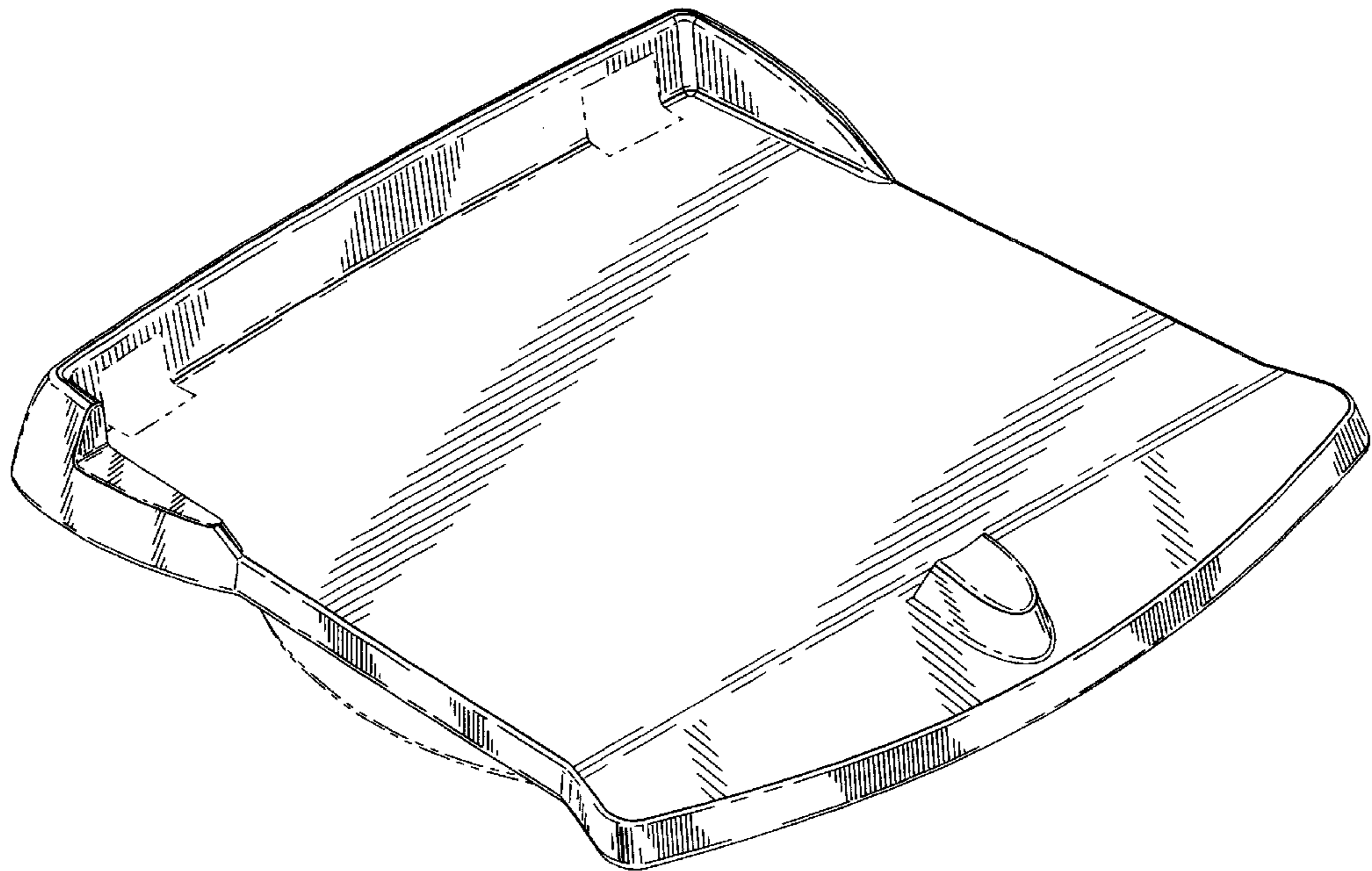
(57) **CLAIM**

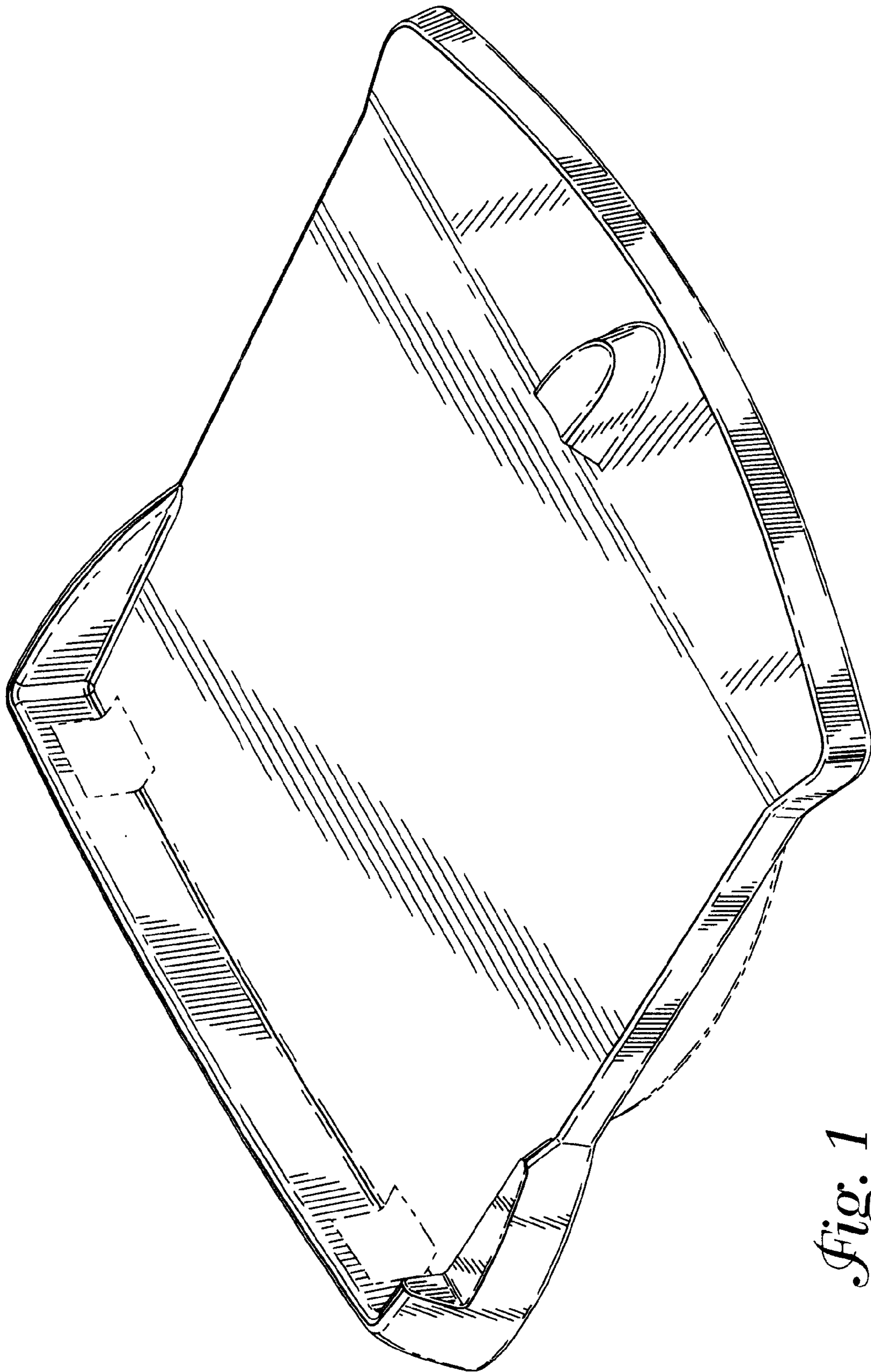
The ornamental design for a docking station, as shown and described.

**DESCRIPTION**

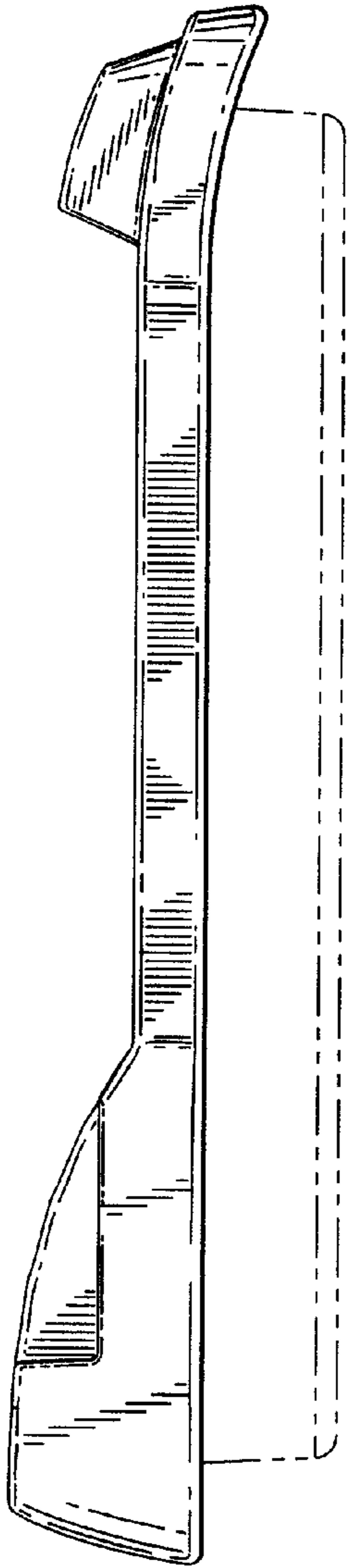
FIG. 1 is a left perspective view of a docking station showing our new design, the broken line portions of the docking station are not part of the claimed design; FIG. 2 is a left side elevation view thereof; FIG. 3 is a right side elevation view thereof; FIG. 4 is a front elevation view thereof; FIG. 5 is a rear elevation view thereof; FIG. 6 is a top plan view thereof; FIG. 7 is a bottom plan view thereof; and, FIG. 8 is a left perspective view of a second embodiment of the docking station.

**1 Claim, 6 Drawing Sheets**

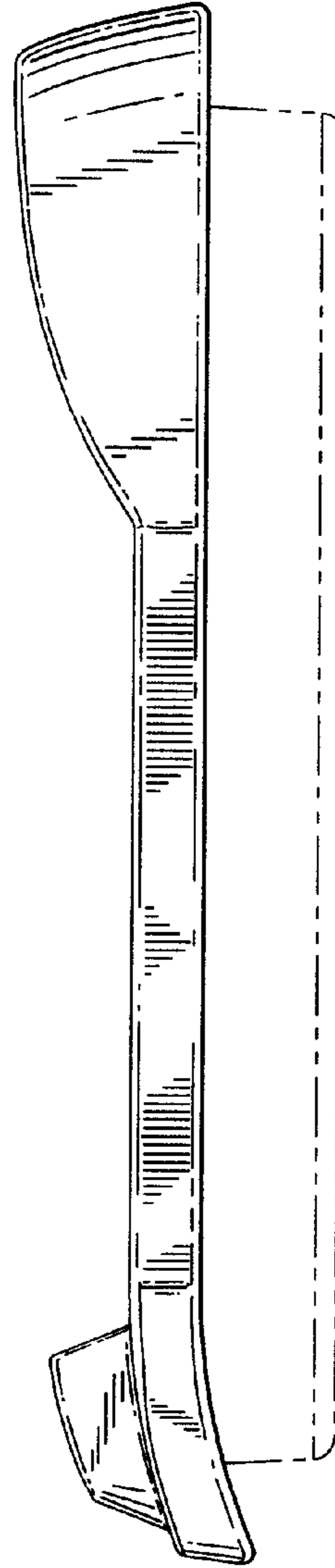




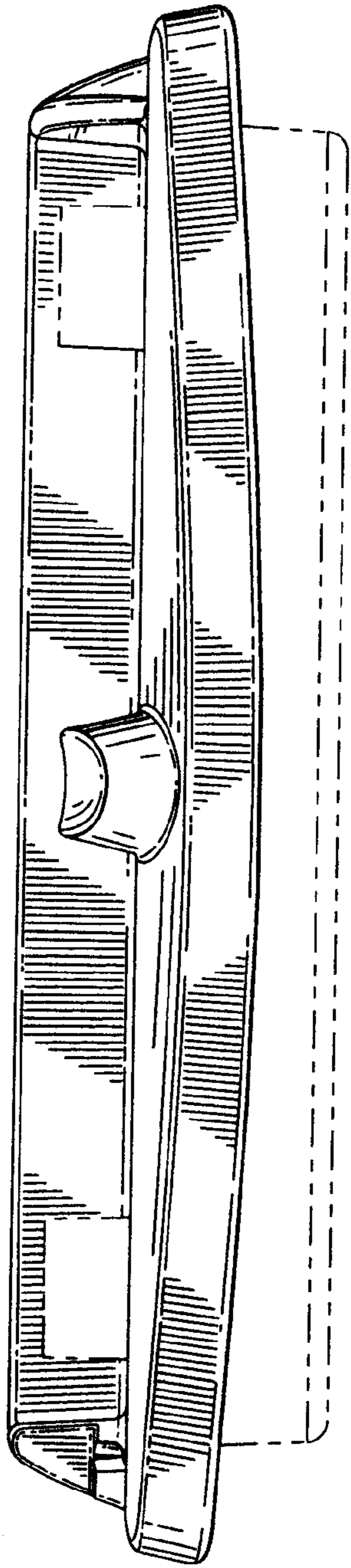
*Fig. 1*



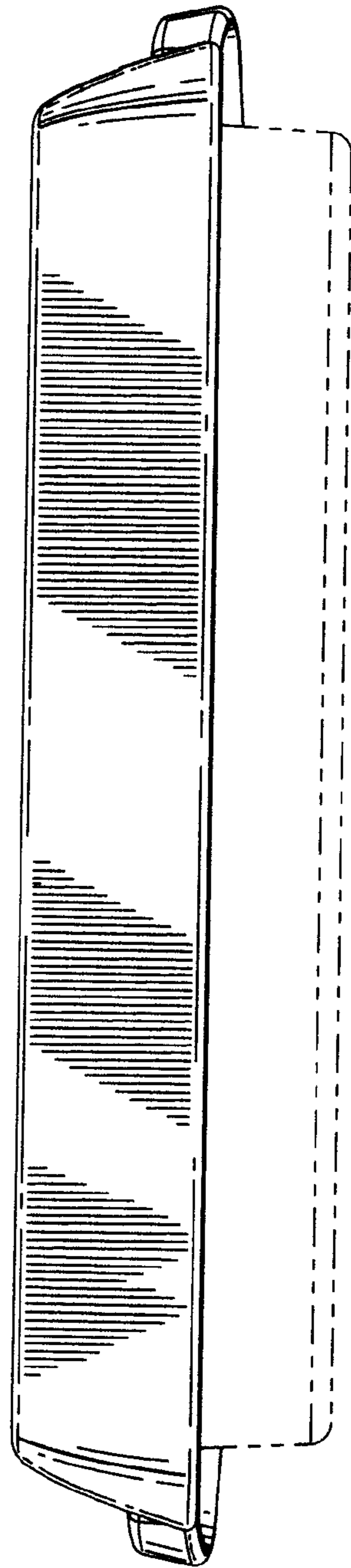
*Fig. 2*



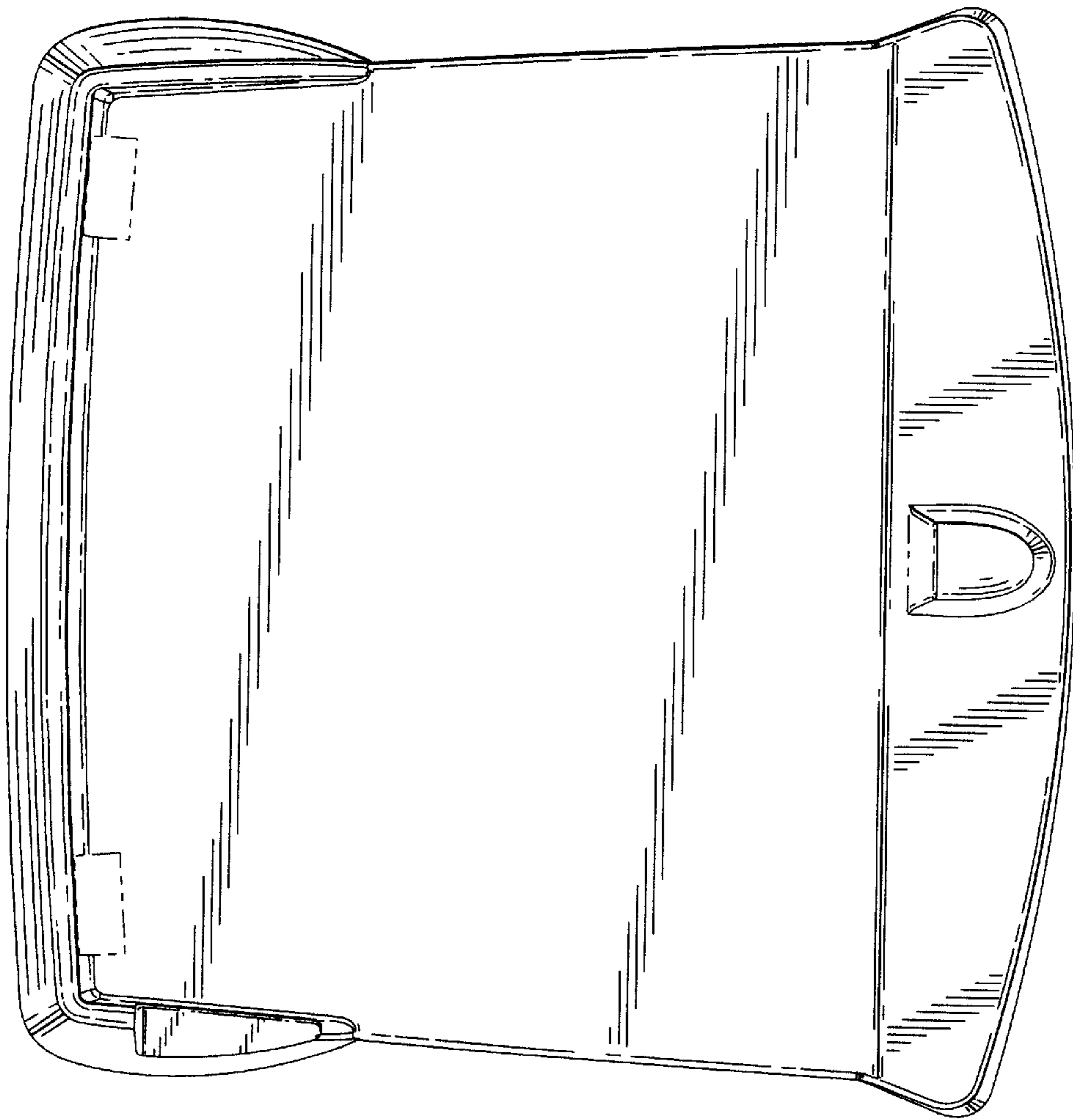
*Fig. 3*



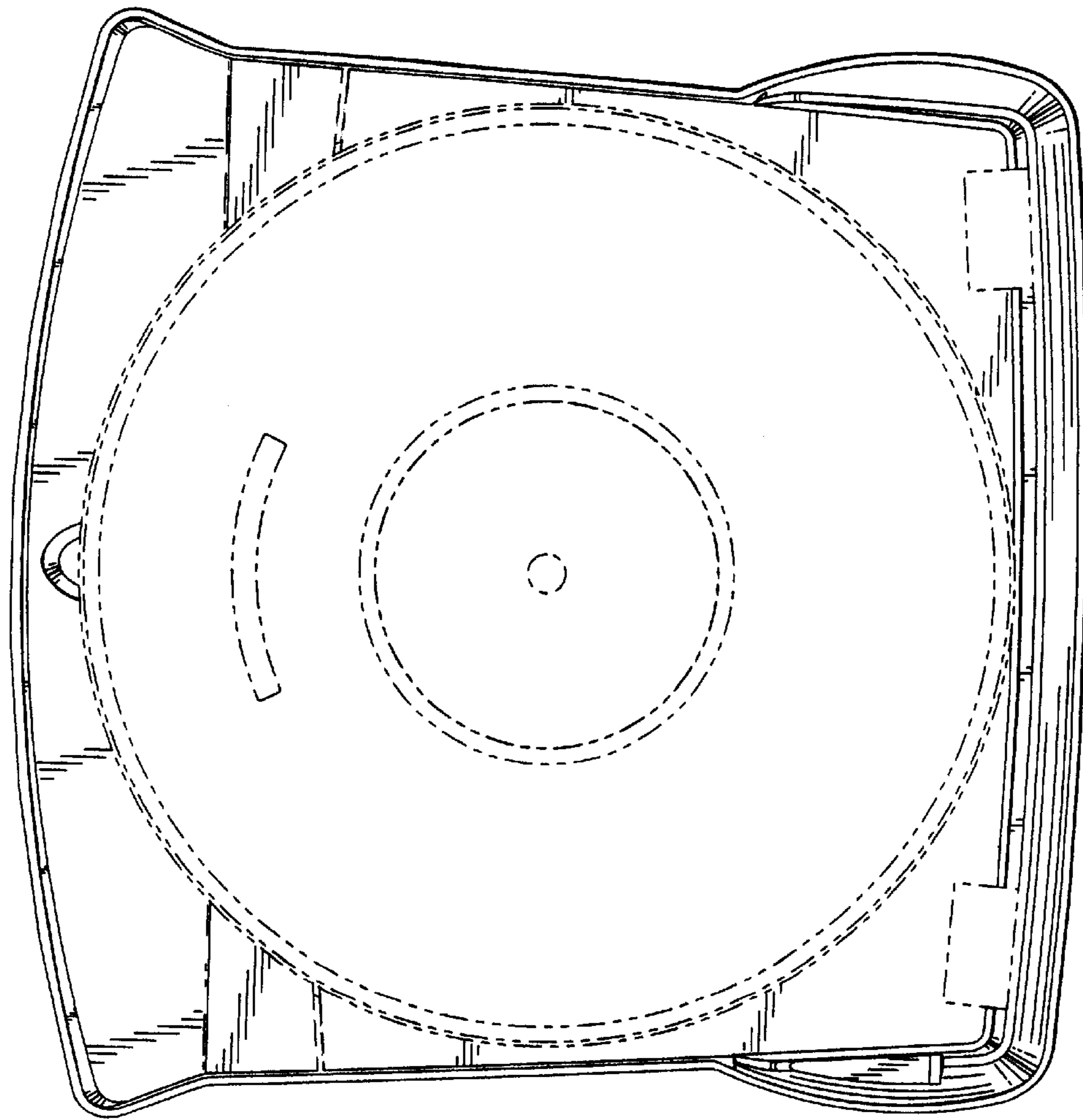
*Fig. 4*



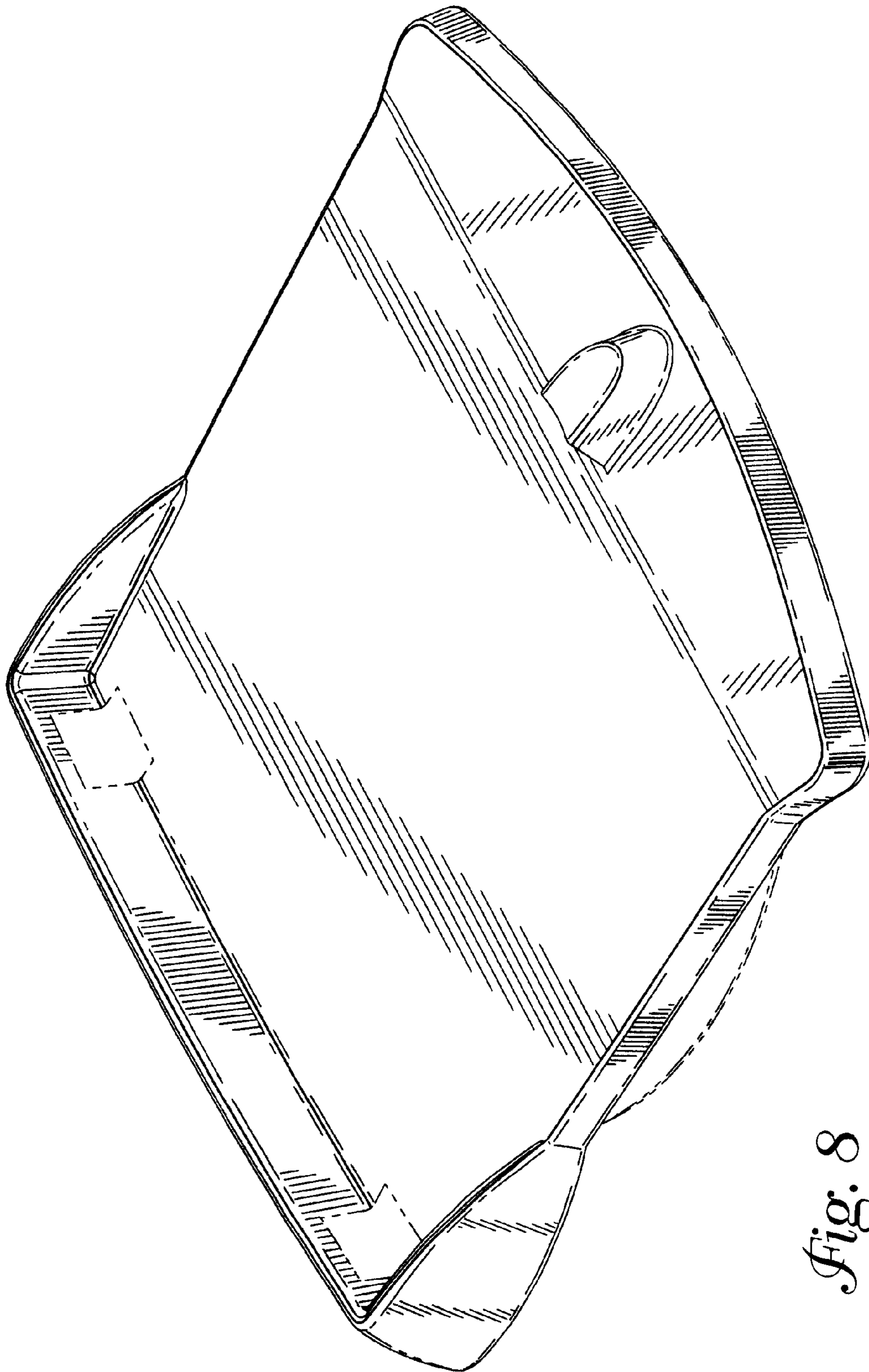
*Fig. 5*



*Fig. 6*



*Fig. 7*



*Fig. 8*