



US00D470836S

(12) **United States Design Patent**
Amae et al.

(10) **Patent No.:** **US D470,836 S**

(45) **Date of Patent:** **** Feb. 25, 2003**

(54) **HEADSET**

(75) Inventors: **Dominic Amae**, Vancouver, WA (US);
Kevin Hlas, Portland, OR (US);
Raymond Weikel, Camas, WA (US);
Robert Jacobson, Camas, WA (US);
Steven Jensen, Vancouver, WA (US);
Omer Kotzer, Portland, OR (US);
Jamian Cobbett, Portland, OR (US);
Aaron David Hayes, Portland, OR (US)

(73) Assignee: **Logitech Europe S.A.**,
Romanel-sur-Morges (CH)

(**) Term: **14 Years**

(21) Appl. No.: **29/161,949**

(22) Filed: **Jun. 5, 2002**

(51) **LOC (7) Cl.** **14-01**

(52) **U.S. Cl.** **D14/223**

(58) **Field of Search** D14/188, 192,
D14/205, 206, 223, 142; 181/129, 130;
379/430, 433; 381/376, 370, 377, 378,
379, 380, 381, 385

(56) **References Cited**

U.S. PATENT DOCUMENTS

4,020,297 A * 4/1977 Brodie 379/430
D284,859 S * 7/1986 Okada D14/192

(List continued on next page.)

Primary Examiner—Paula A. Mortimer

(74) *Attorney, Agent, or Firm*—Ipsolon LLP

(57) **CLAIM**

The ornamental design for a headset, as shown and described.

DESCRIPTION

FIG. 1 is a perspective view of a headset showing our new design;

FIG. 2 is a left side view thereof;

FIG. 3 is a right side view thereof;

FIG. 4 is a bottom view thereof;

FIG. 5 is a front view thereof;

FIG. 6 is a top view thereof;

FIG. 7 is a back view thereof;

FIG. 8 is a perspective view thereof with the microphone shown in a second alternative position;

FIG. 9 is a left side view thereof with the microphone shown in the second alternative position of FIG. 8;

FIG. 10 is a right side view thereof with the microphone shown in the second alternative position of FIG. 8;

FIG. 11 is a bottom view thereof with the microphone shown in the second alternative position of FIG. 8;

FIG. 12 is a front view thereof with the microphone shown in the second alternative position of FIG. 8;

FIG. 13 is a top view thereof with the microphone shown in the second alternative position of FIG. 8;

FIG. 14 is a back view thereof with the microphone shown in the second alternative position of FIG. 8;

FIG. 15 is a back view of an alternative embodiment of the headset showing our new design with the microphone shown in the second alternative position;

FIG. 16 is a top view of the alternative embodiment thereof of FIG. 15;

FIG. 17 is a front view of the alternative embodiment thereof of FIG. 15;

FIG. 18 is a bottom view of the alternative embodiment thereof of FIG. 15; and,

FIG. 19 is a back view of the alternative embodiment thereof of FIG. 15.

The broken lines showing recesses, vents, a control button, a pivot joint, an ear pad, and ports are for illustrative purpose only and form no part of the claimed design. The alternative embodiment of FIGS. 15–19 has surface contours substantially as shown and shaded for corresponding like surfaces of the embodiment of FIGS. 1–14.

1 Claim, 6 Drawing Sheets

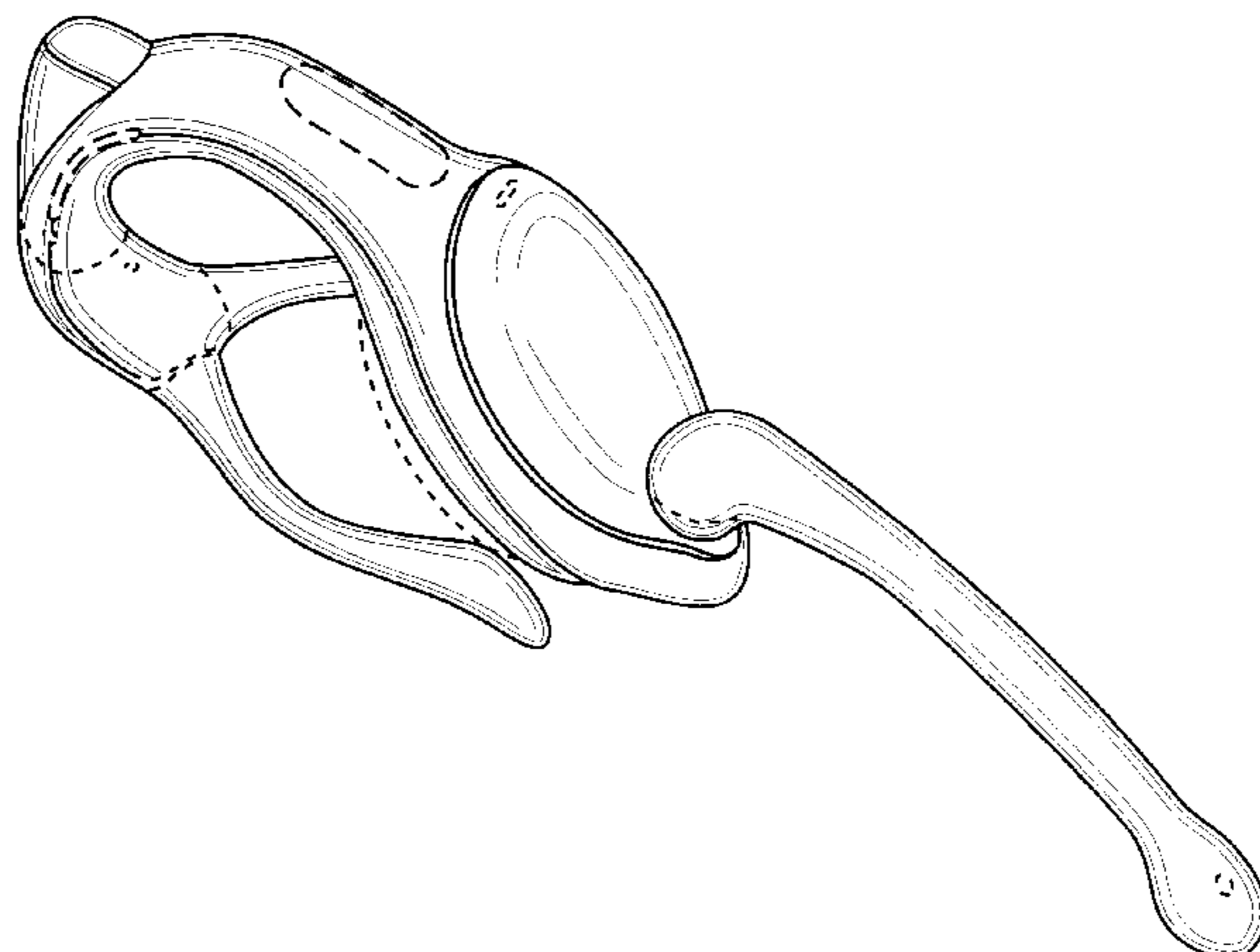

US D470,836 S

Page 2

U.S. PATENT DOCUMENTS

D366,486 S	*	1/1996	Runquist et al.	D14/206	D443,871 S	*	6/2001	Hofstede et al.	D14/206
5,655,026 A	*	8/1997	Peters et al.	381/385	D451,907 S	*	12/2001	Amae et al.	D14/223
D403,327 S	*	12/1998	Landreth et al.	D14/223	D455,417 S	*	4/2002	Bey et al.	D14/223
D431,235 S	*	9/2000	Lyman et al.	D14/142	D455,732 S	*	4/2002	Skulley et al.	D14/223
D439,890 S	*	4/2001	Skulley et al.	D14/223					

* cited by examiner

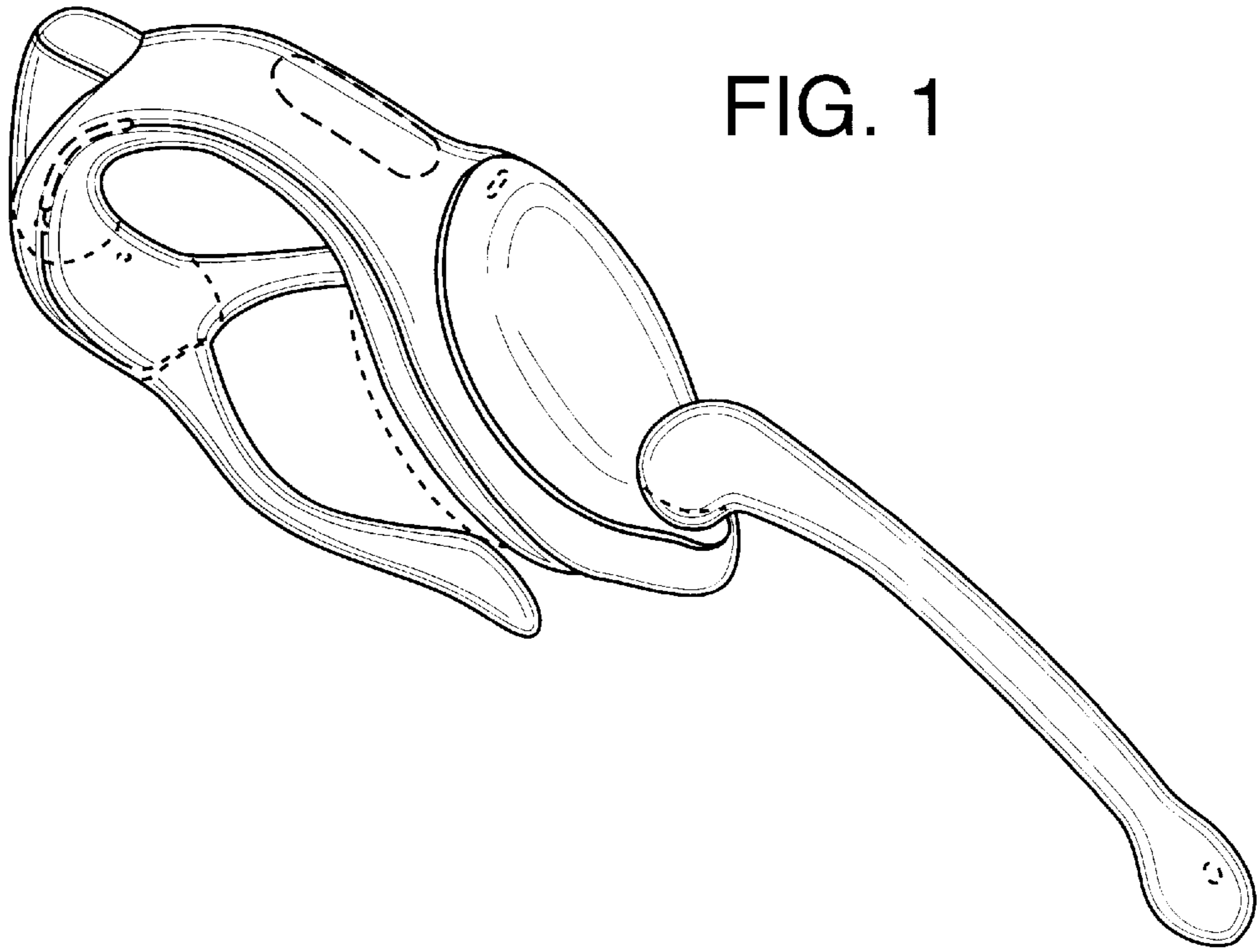

FIG. 1

FIG. 2

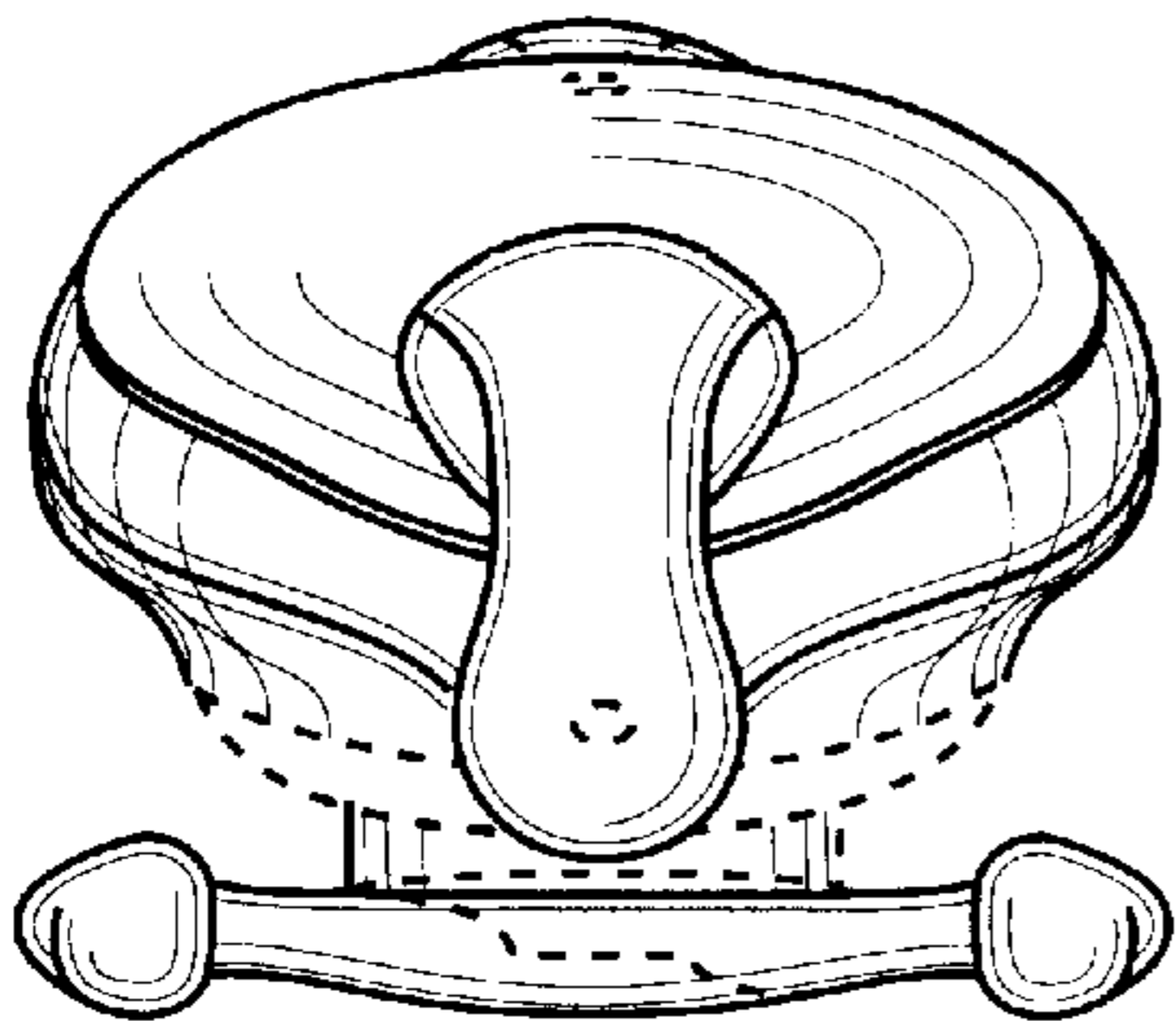

FIG. 3

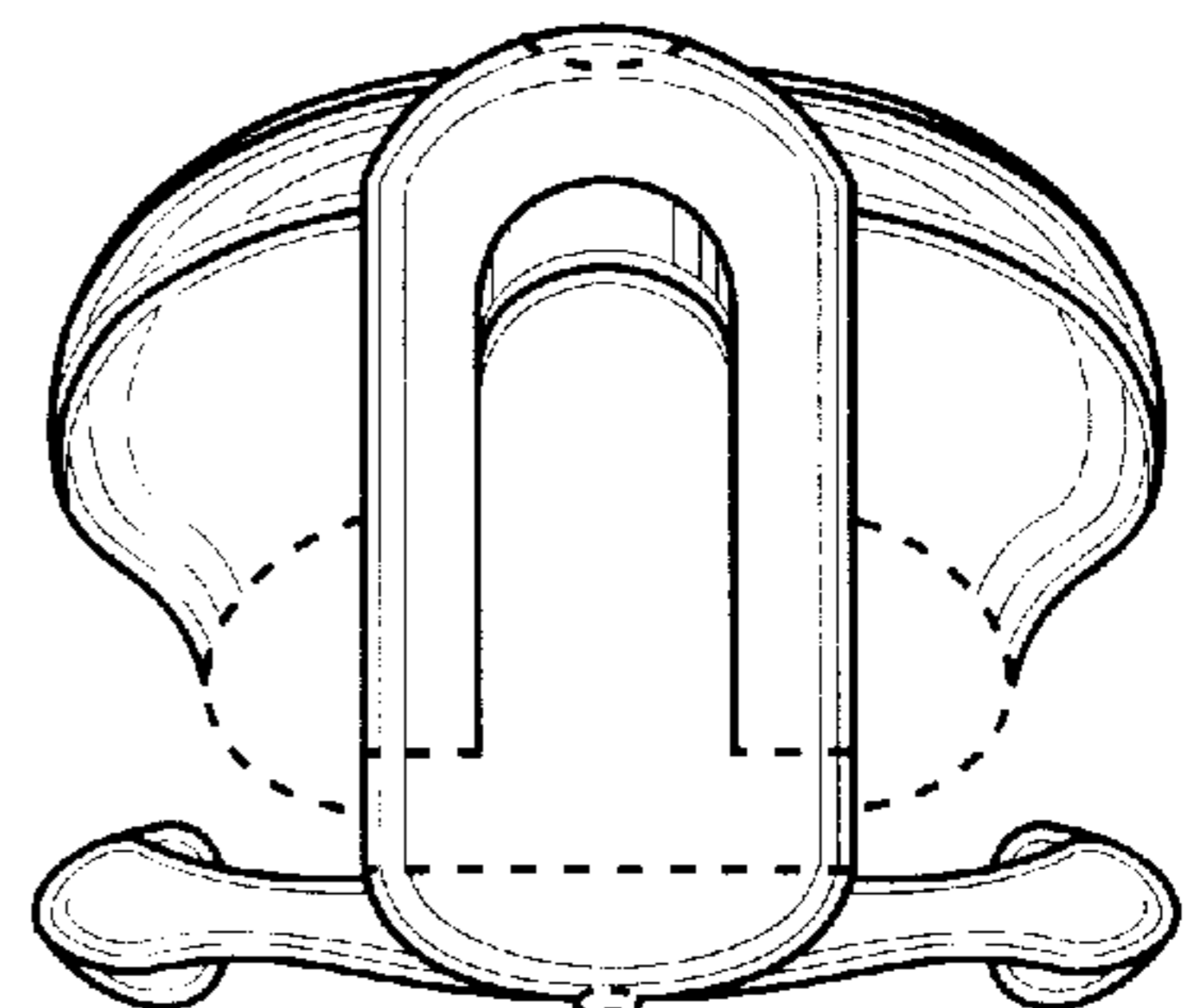

FIG. 4

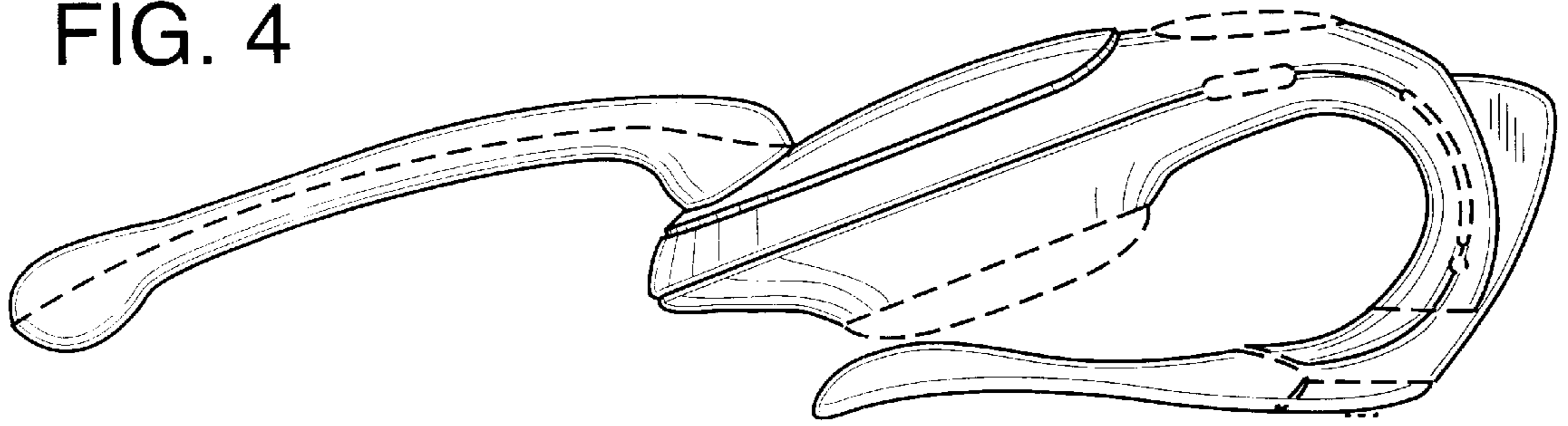

FIG. 5

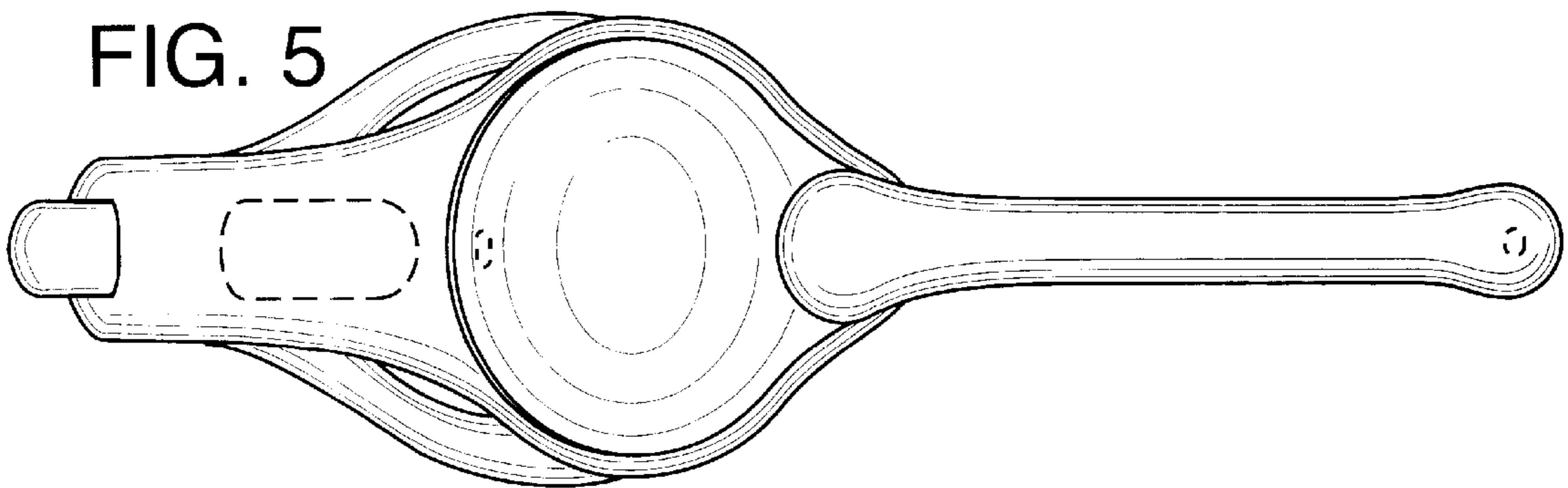

FIG. 6

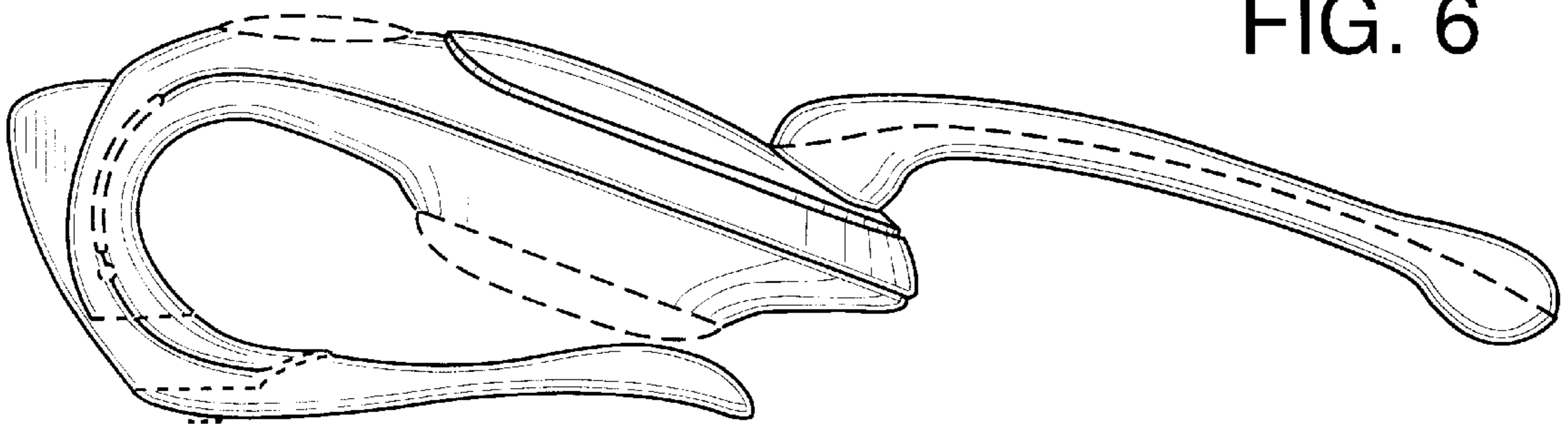
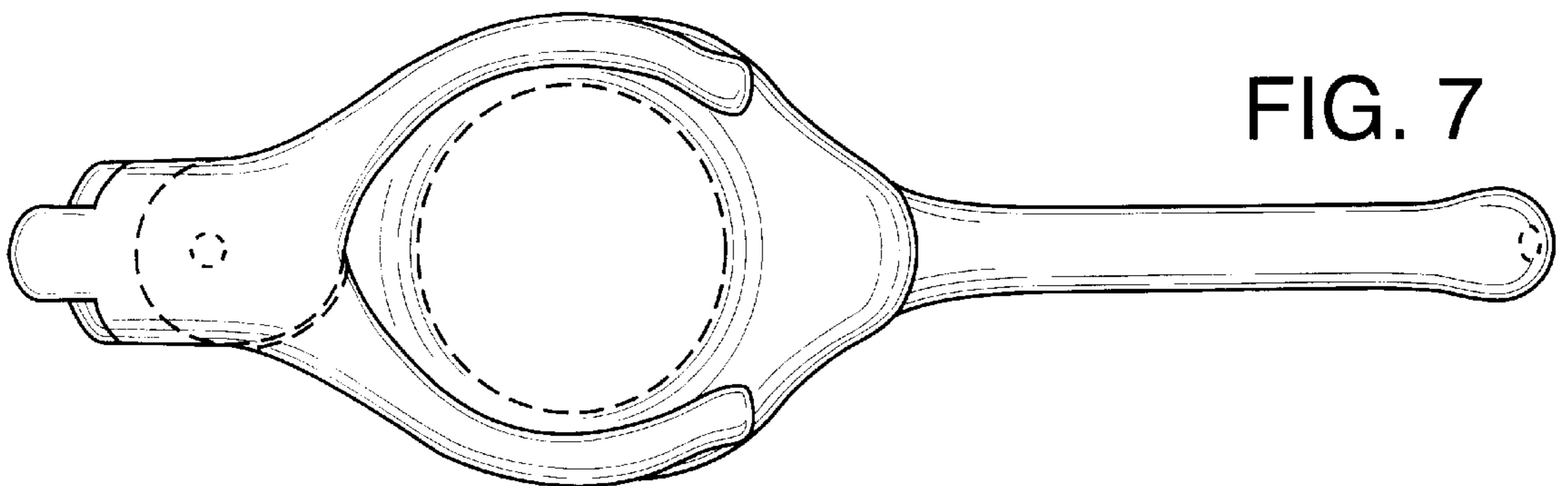

FIG. 7



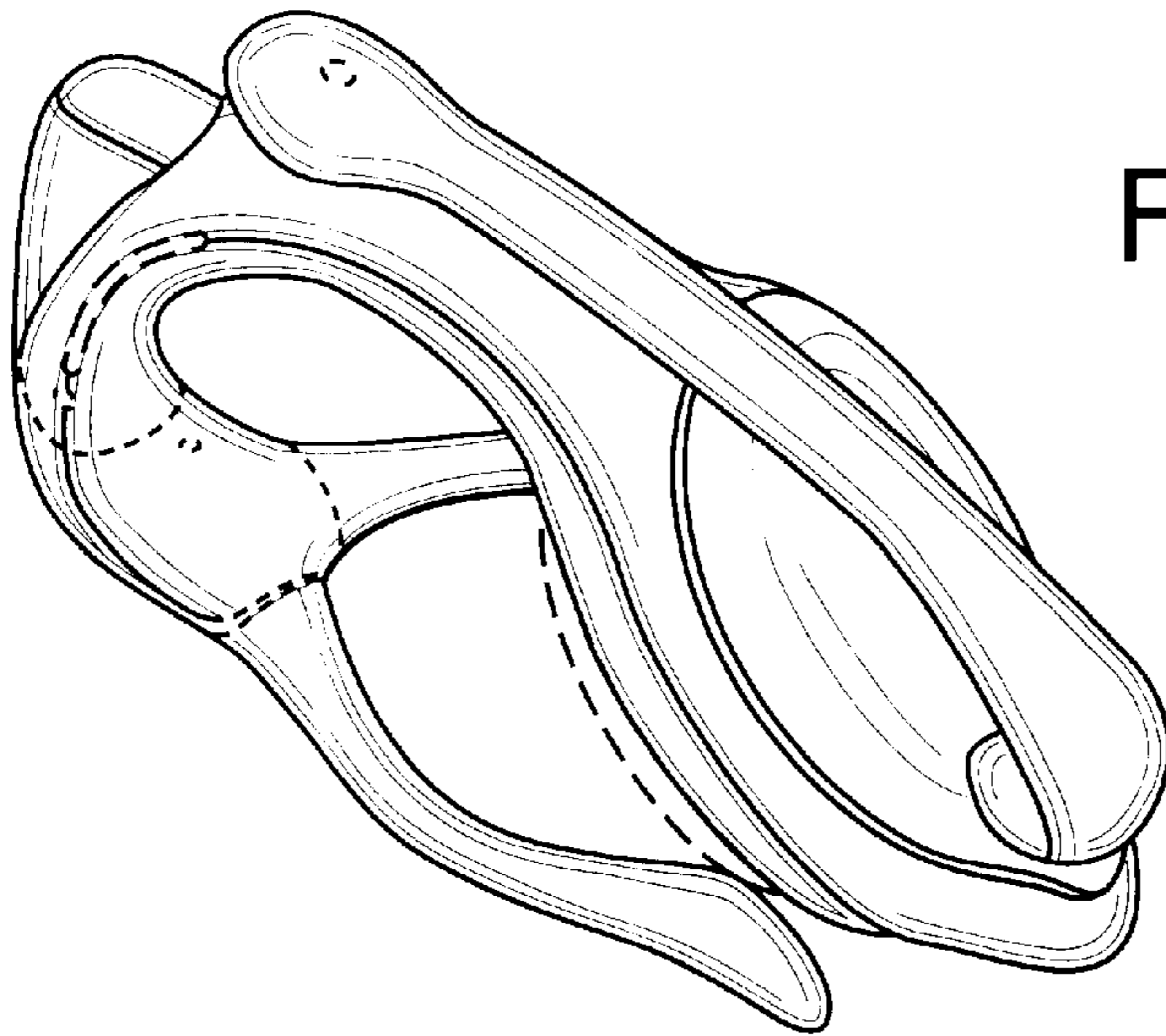

FIG. 8

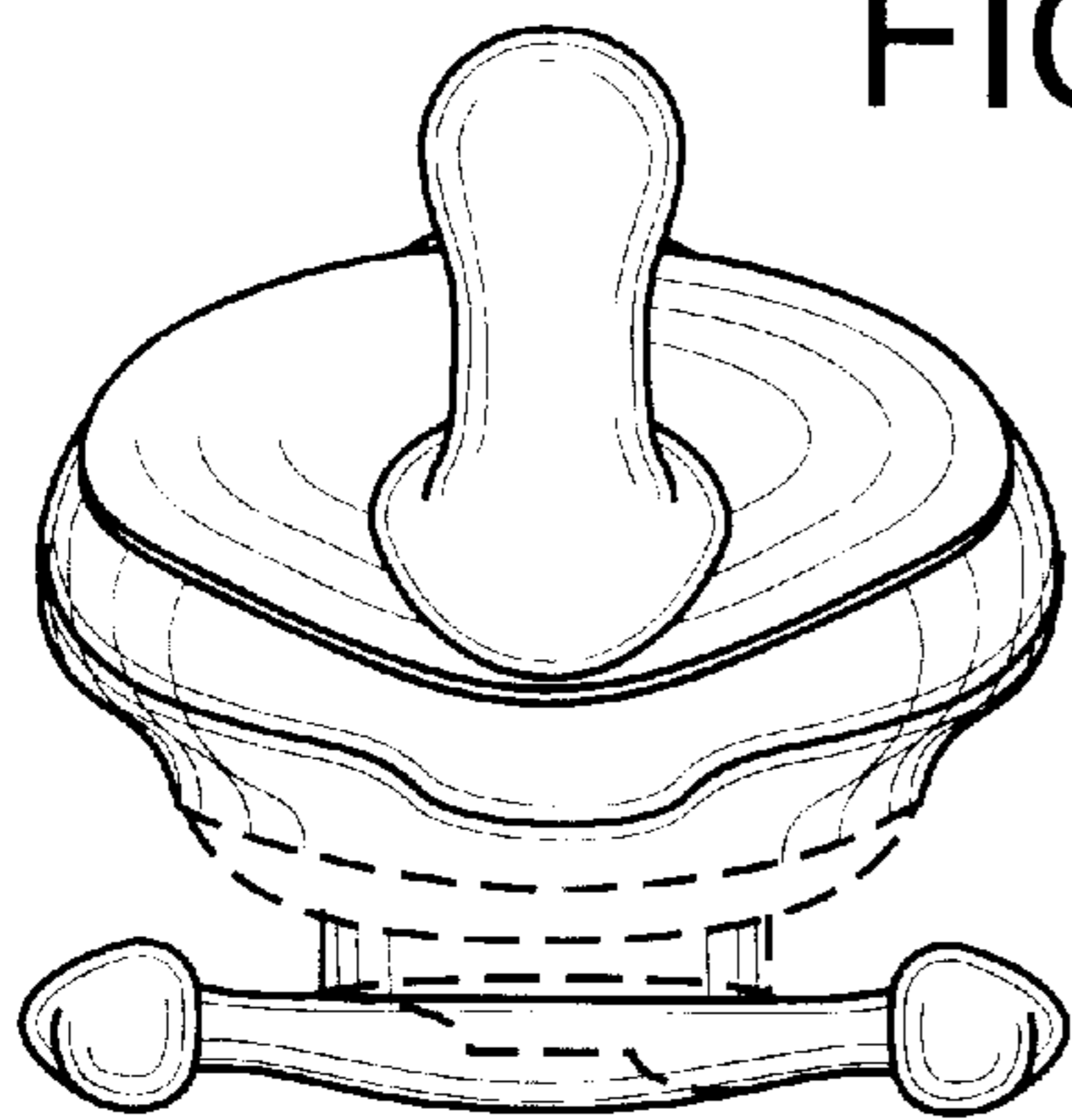

FIG. 9

FIG. 10

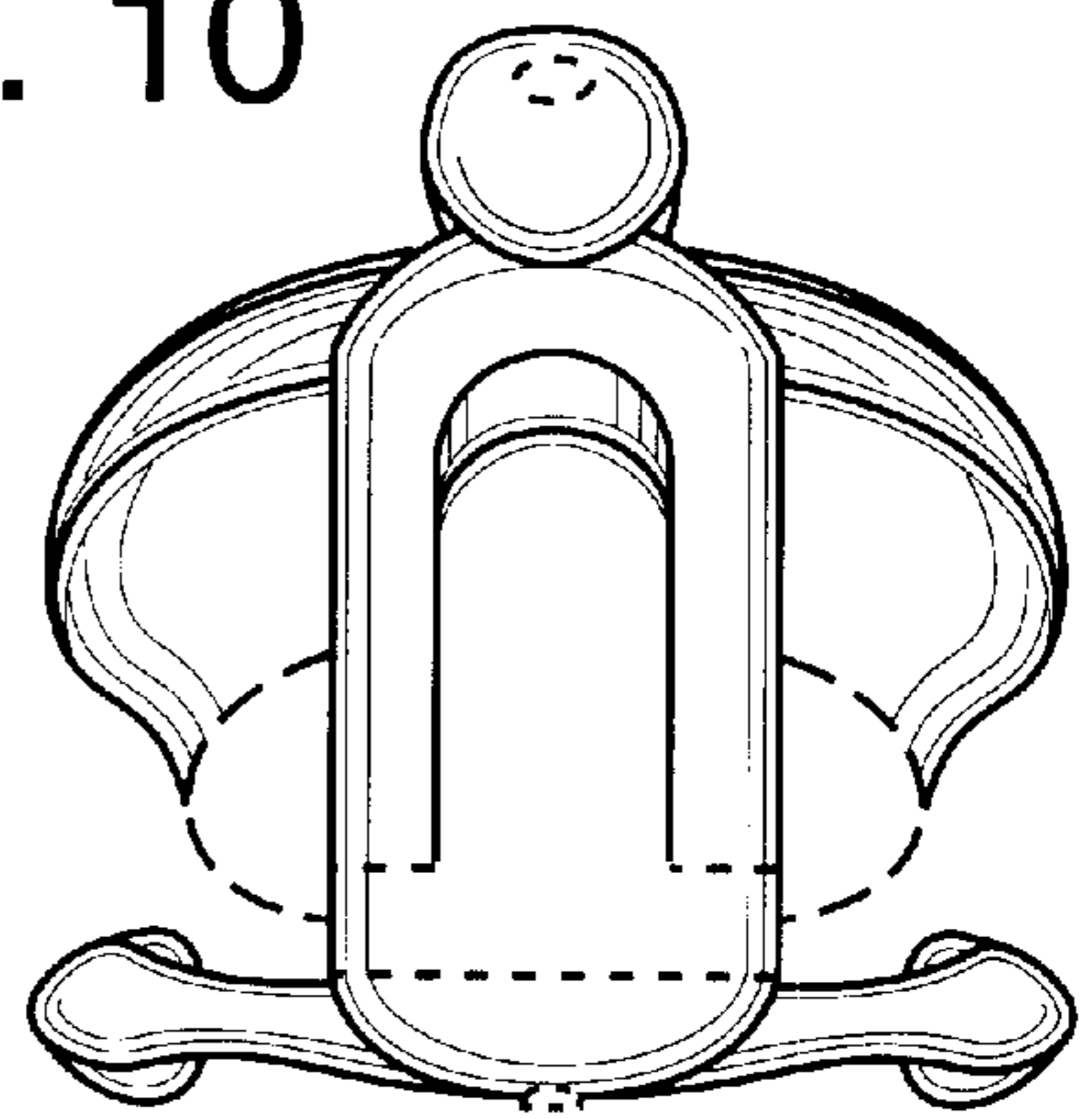

FIG. 11

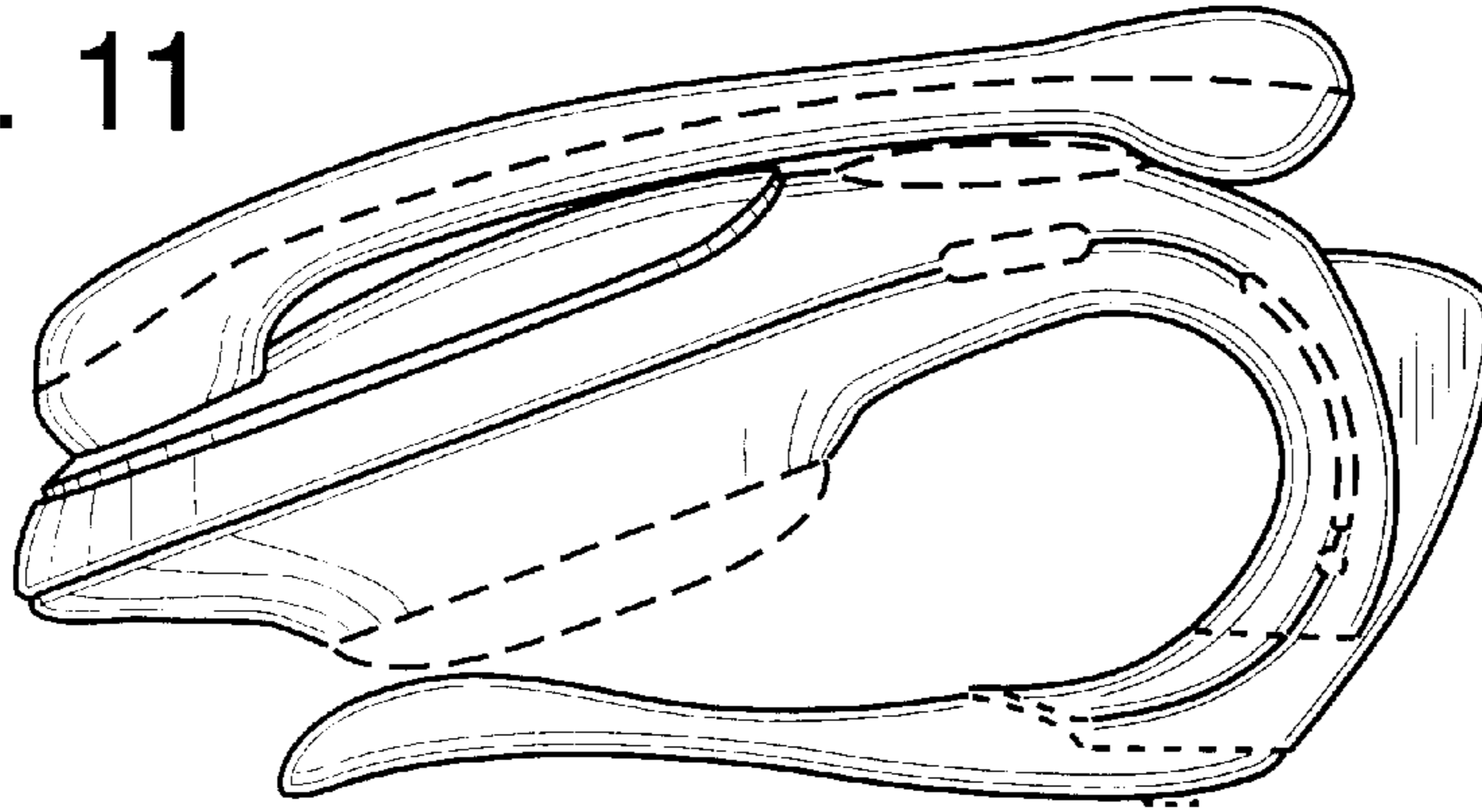

FIG. 12

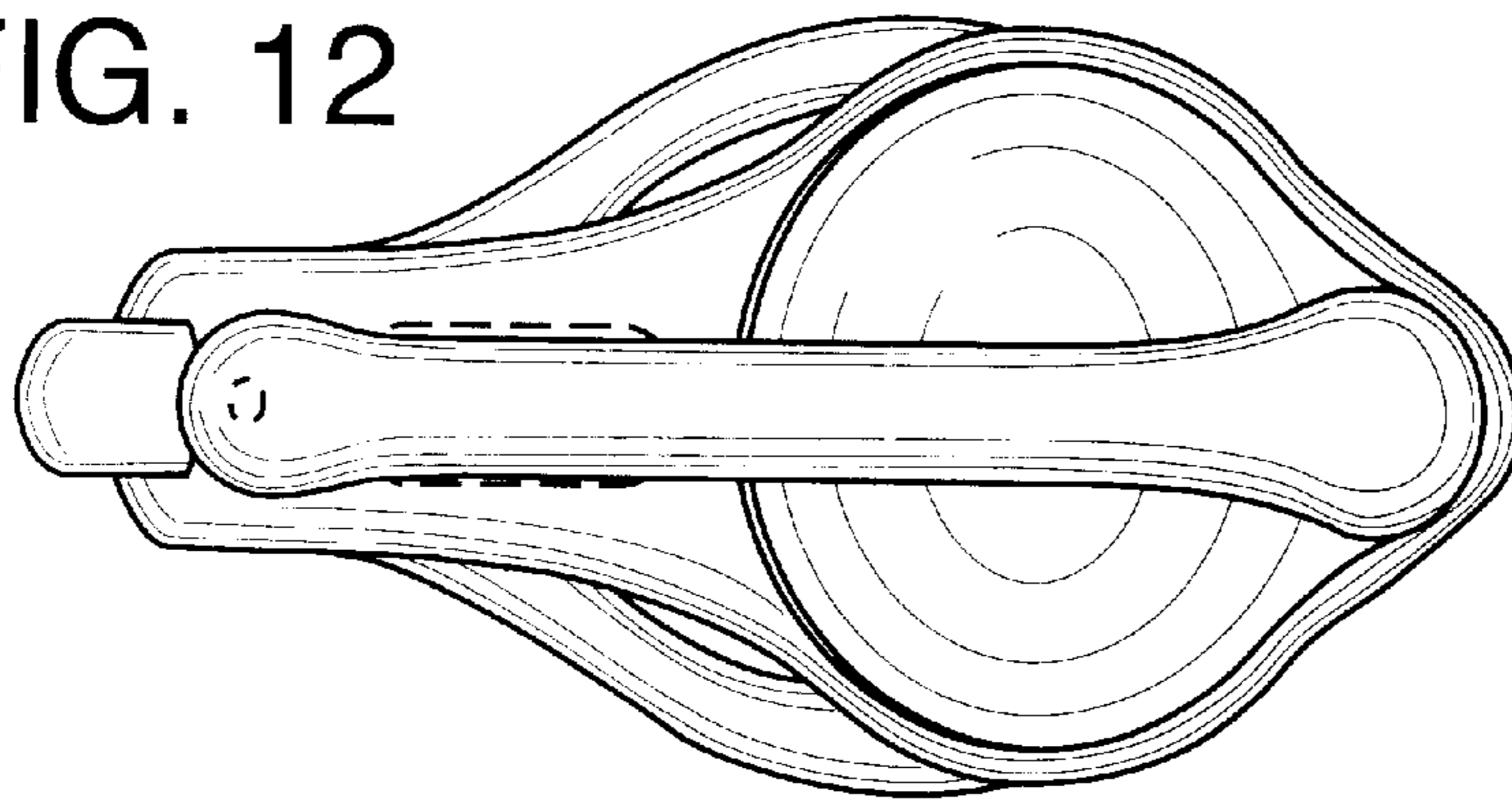

FIG. 13

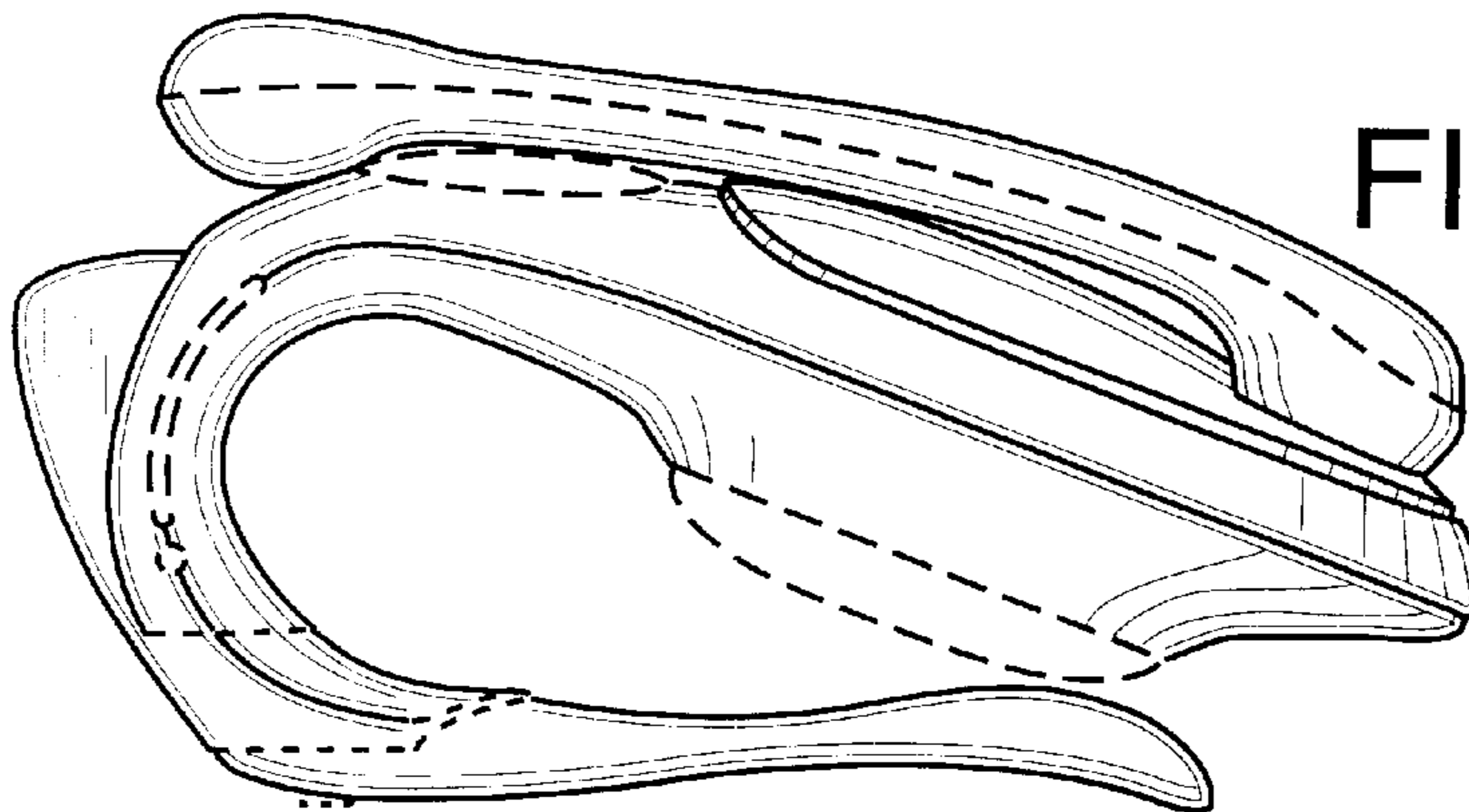

FIG. 14

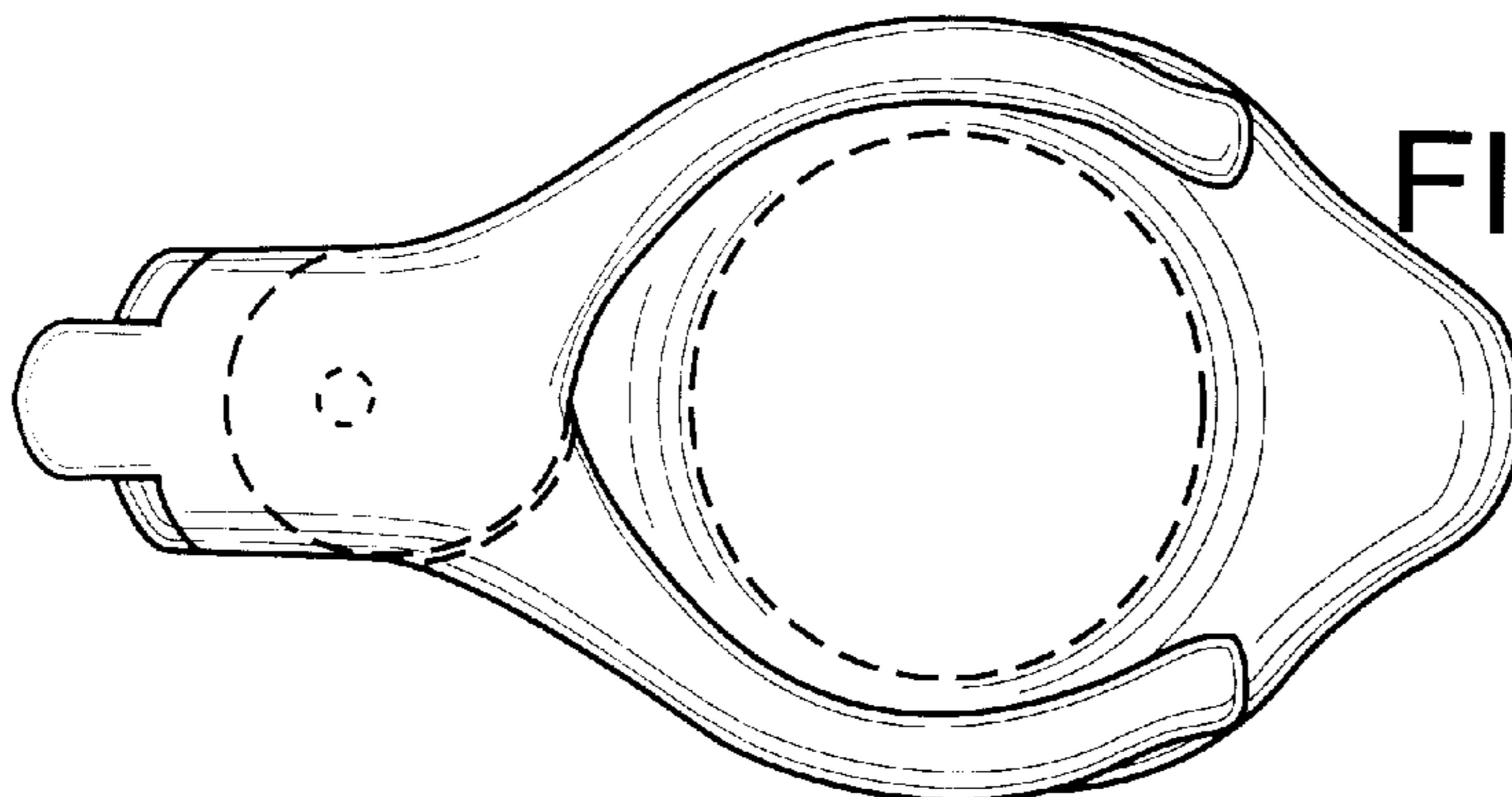

FIG. 15

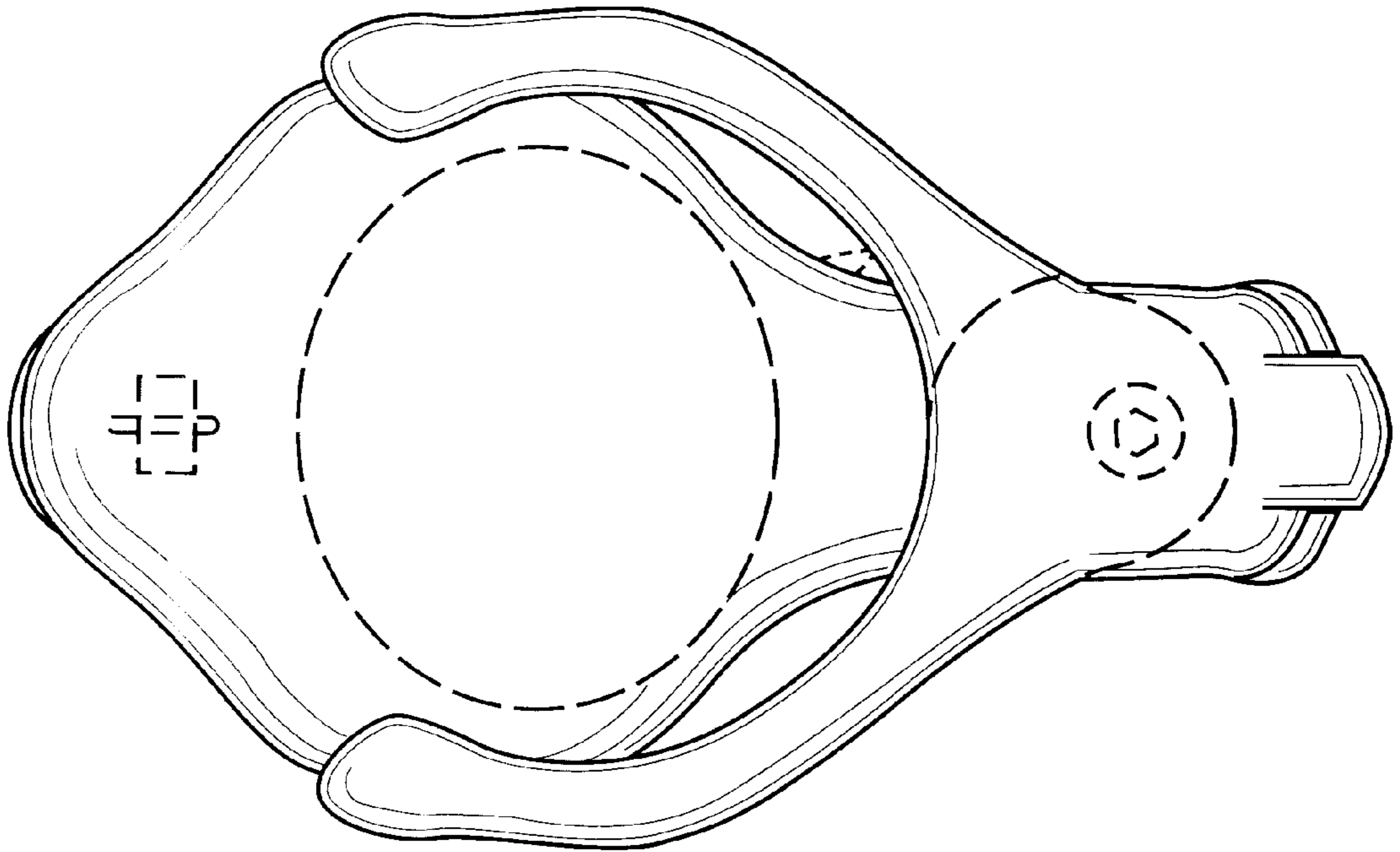

FIG. 16

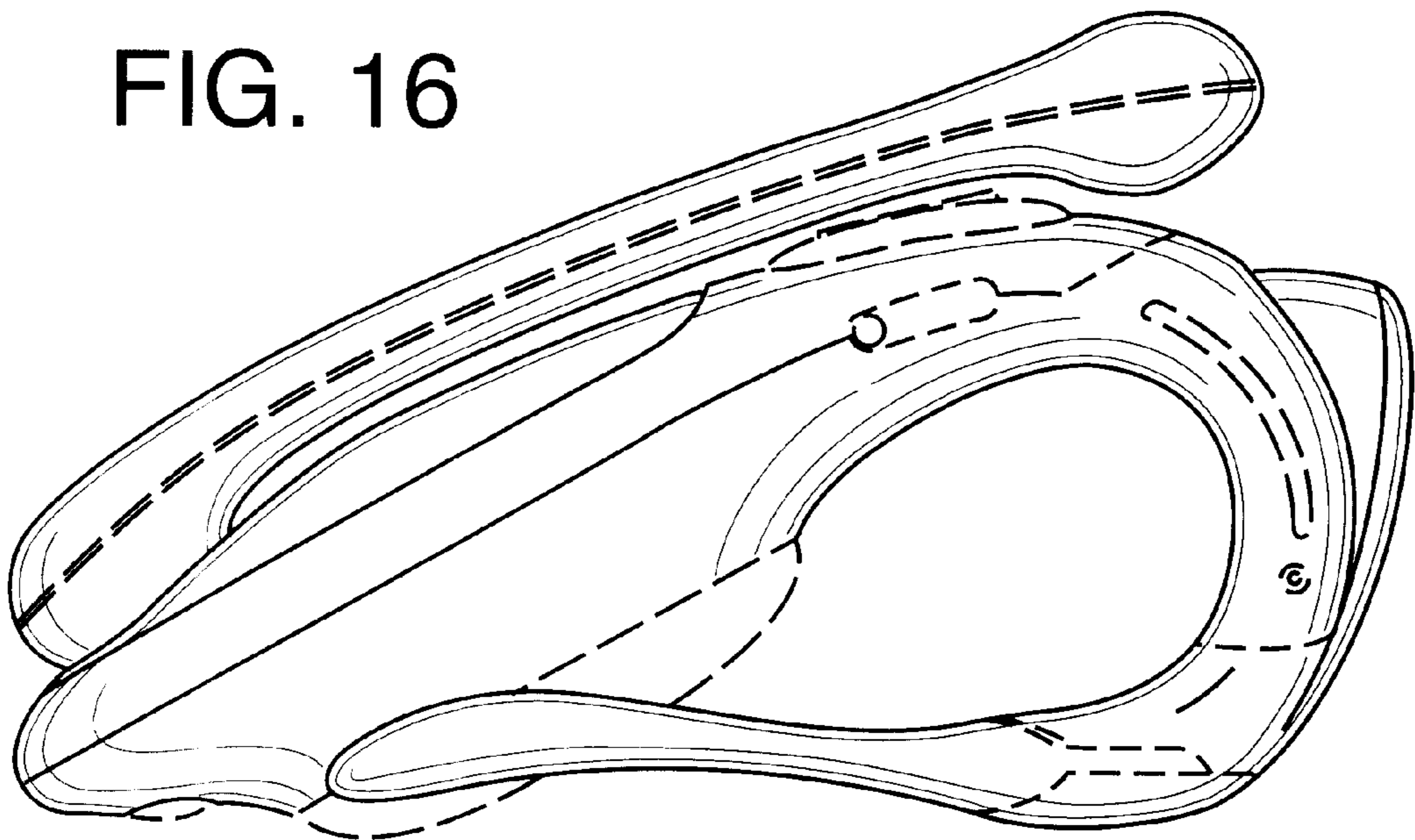

FIG. 17

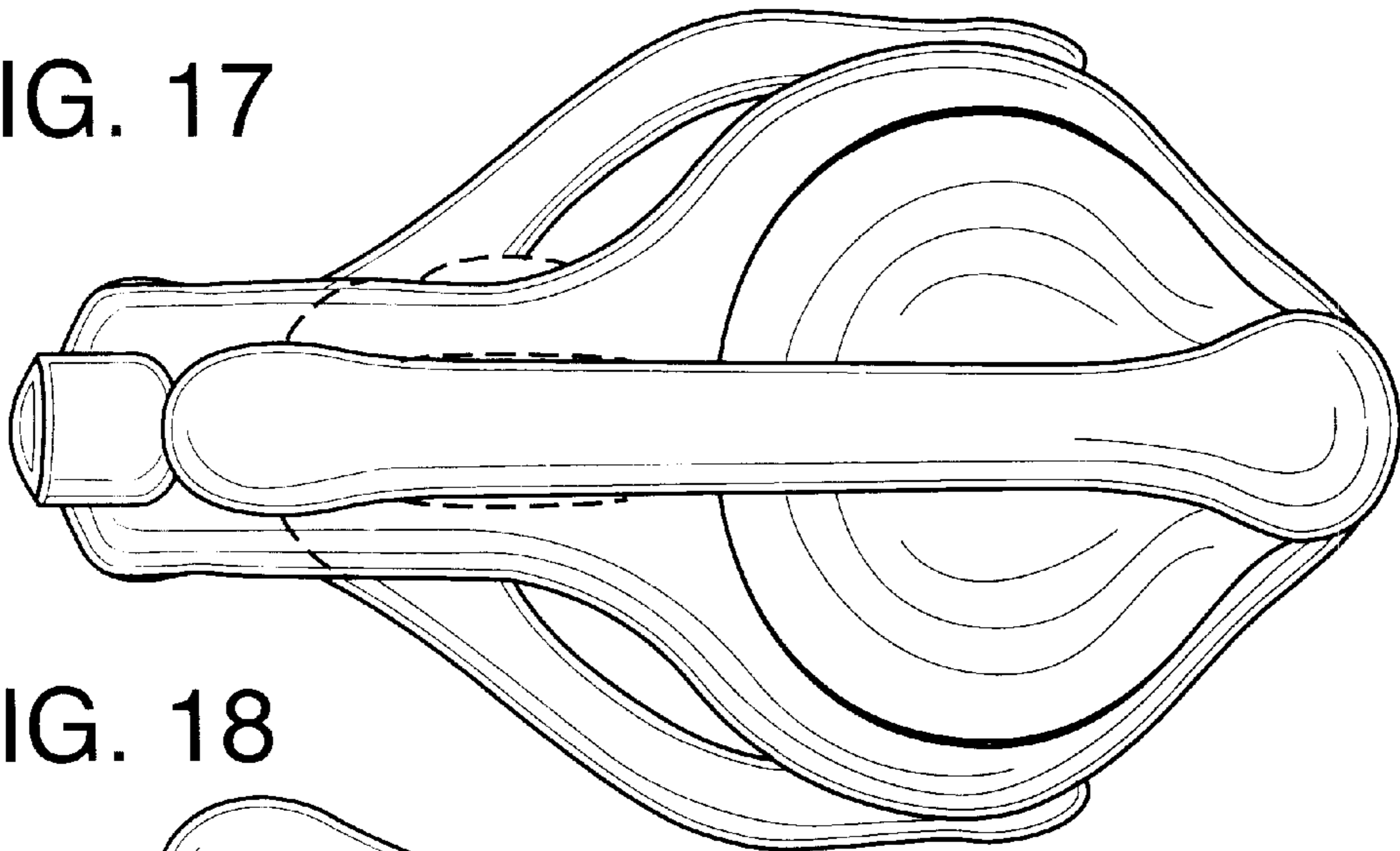

FIG. 18

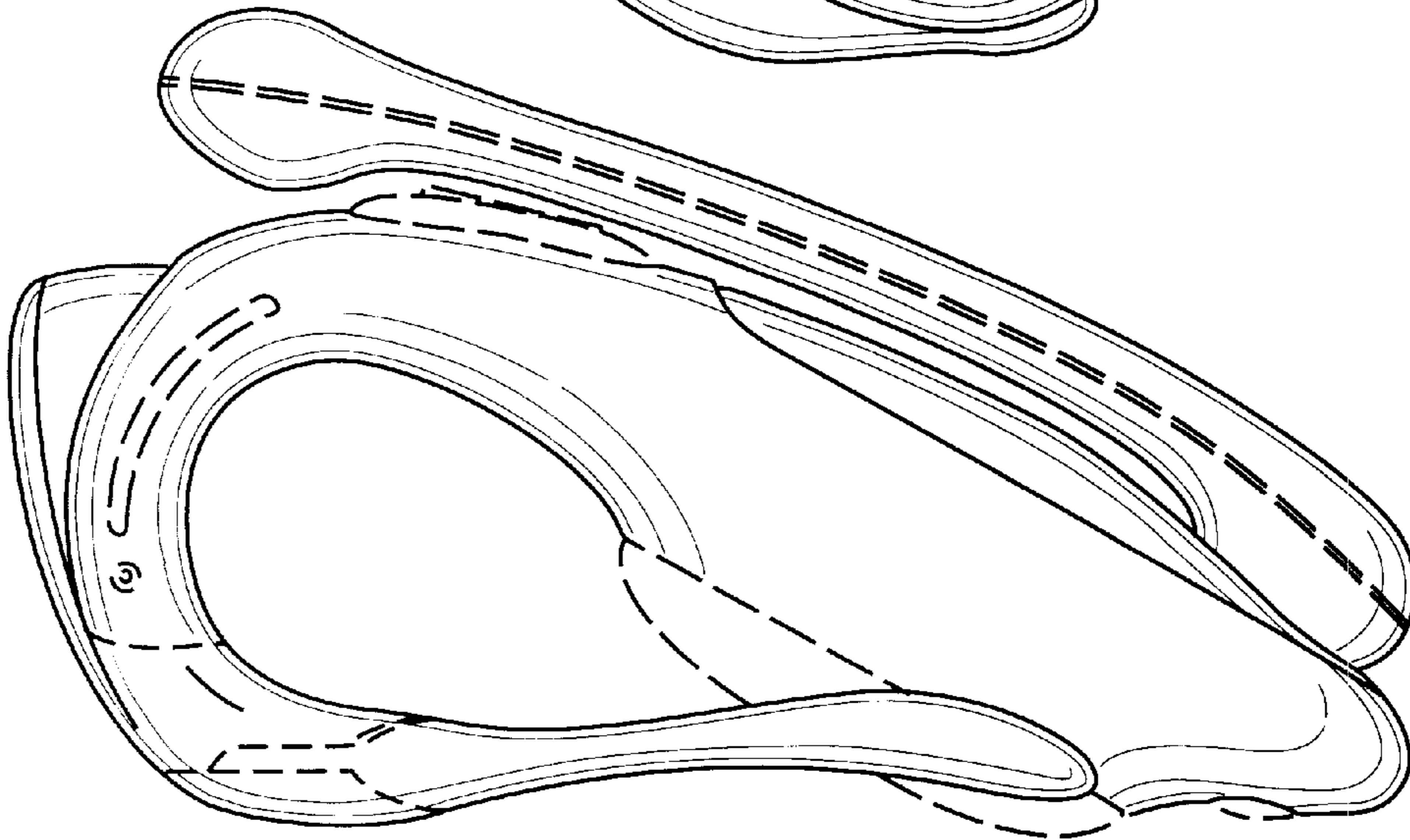

FIG. 19

