



US00D470707S

(12) **United States Design Patent**  
**Lopez Mas**

(10) **Patent No.:** **US D470,707 S**

(45) **Date of Patent:** **\*\* Feb. 25, 2003**

(54) **CASES FOR DATA DISKS**

(76) Inventor: **Antonia Lopez Mas**, Escuelas Pias, 32,  
08017 Barcelona (ES)

(\*\*) Term: **14 Years**

(21) Appl. No.: **29/111,885**

(22) Filed: **Oct. 7, 1999**

(30) **Foreign Application Priority Data**

Feb. 14, 2000 (ES) ..... 146130

(51) **LOC (7) Cl.** ..... **06-04**

(52) **U.S. Cl.** ..... **D6/634; D6/407; D6/635**

(58) **Field of Search** ..... D3/201-218; D6/407,  
D6/626-635; D19/26, 27, 32; 206/307.1,  
308.1, 308.2, 308.3, 311, 312, 387.11, 387.13,  
387.15; 369/37, 75.2, 291; 379/355

(56) **References Cited**

**U.S. PATENT DOCUMENTS**

|                |         |                        |       |           |
|----------------|---------|------------------------|-------|-----------|
| 4,089,414 A *  | 5/1978  | Sandor et al.          | ..... | 206/308.3 |
| D347,320 S *   | 5/1994  | Corday                 | ..... | D6/634    |
| 5,788,068 A *  | 8/1998  | Fraser et al.          | ..... | 206/310   |
| D411,071 S *   | 6/1999  | Cerda-Vicedo           | ..... | D6/632    |
| 5,944,181 A *  | 8/1999  | Lau                    | ..... | 206/308.1 |
| 5,996,788 A *  | 12/1999 | Belden, Jr. et al.     | ..... | 206/310   |
| D420,240 S *   | 2/2000  | Sorenson et al.        | ..... | D6/632    |
| D426,978 S *   | 6/2000  | Belden, Jr. et al.     | ..... | D6/407    |
| 6,164,446 A *  | 12/2000 | Law                    | ..... | 206/308.1 |
| D437,171 S *   | 2/2001  | Cuadrado-Serena        | ..... | D6/632    |
| D437,520 S *   | 2/2001  | Choi                   | ..... | D6/632    |
| 6,196,384 B1 * | 3/2001  | Belden, Jr.            | ..... | 206/308.1 |
| 6,206,185 B1 * | 3/2001  | Ke et al.              | ..... | 206/308.1 |
| 6,206,186 B1 * | 3/2001  | Cerda-Vilaplana et al. | ..... | 206/308.1 |
| 6,227,362 B1 * | 5/2001  | Cheung                 | ..... | 206/308.1 |
| 6,237,763 B1 * | 5/2001  | Lau                    | ..... | 206/308.1 |
| 6,241,089 B1 * | 6/2001  | Grobecker              | ..... | 206/310   |
| 6,276,524 B1 * | 8/2001  | Cerda-Vilaplana et al. | ..... | 206/308.1 |
| 6,293,396 B1 * | 9/2001  | Takahashi et al.       | ..... | 206/310   |

\* cited by examiner

*Primary Examiner*—Celia Murphy

(74) *Attorney, Agent, or Firm*—Blank Rome Comisky & McCauley LLP

(57) **CLAIM**

The ornamental designs for cases for data discs, as shown and described.

**DESCRIPTION**

FIG. 1 is a plan view of a first embodiment of my case in an open position showing the outside surfaces;  
 FIG. 2 is a plan view of a first embodiment of my case in an open position showing the inside surfaces;  
 FIG. 3 is a side view of my case shown in FIG. 2 viewed from the right side;  
 FIG. 4 is a side view of my case shown in FIG. 2 viewed from the bottom;  
 FIG. 5 is a perspective view of a first embodiment of my case in a closed position viewed from the front surface;  
 FIG. 6 is a perspective view of a first embodiment of my case in a closed position viewed from the rear surface;  
 FIG. 7 is an enlarged perspective view of the central hub portion of my case shown in FIG. 2;  
 FIG. 8 is a cross-sectional view of section A—A of my case shown in FIG. 2;  
 FIG. 9 is a plan view of a second embodiment of my case in an open position showing the outside surfaces;  
 FIG. 10 is a plan view of a second embodiment of my case in an open position showing the inside surfaces;  
 FIG. 11 is a side view of my case shown in FIG. 10 viewed from the right side;  
 FIG. 12 is a side view of my case shown in FIG. 10 viewed from the bottom;  
 FIG. 13 is a perspective view of a second embodiment of my case in a closed position viewed from the front surface;  
 FIG. 14 is a perspective view of a second embodiment of my case in a closed position viewed from the rear surface;  
 FIG. 15 is an enlarged perspective view of the central hub portion of my case shown in FIG. 10; and,  
 FIG. 16 is a side cross-sectional view of section B—B of my case shown in FIG. 10.

**1 Claim, 12 Drawing Sheets**

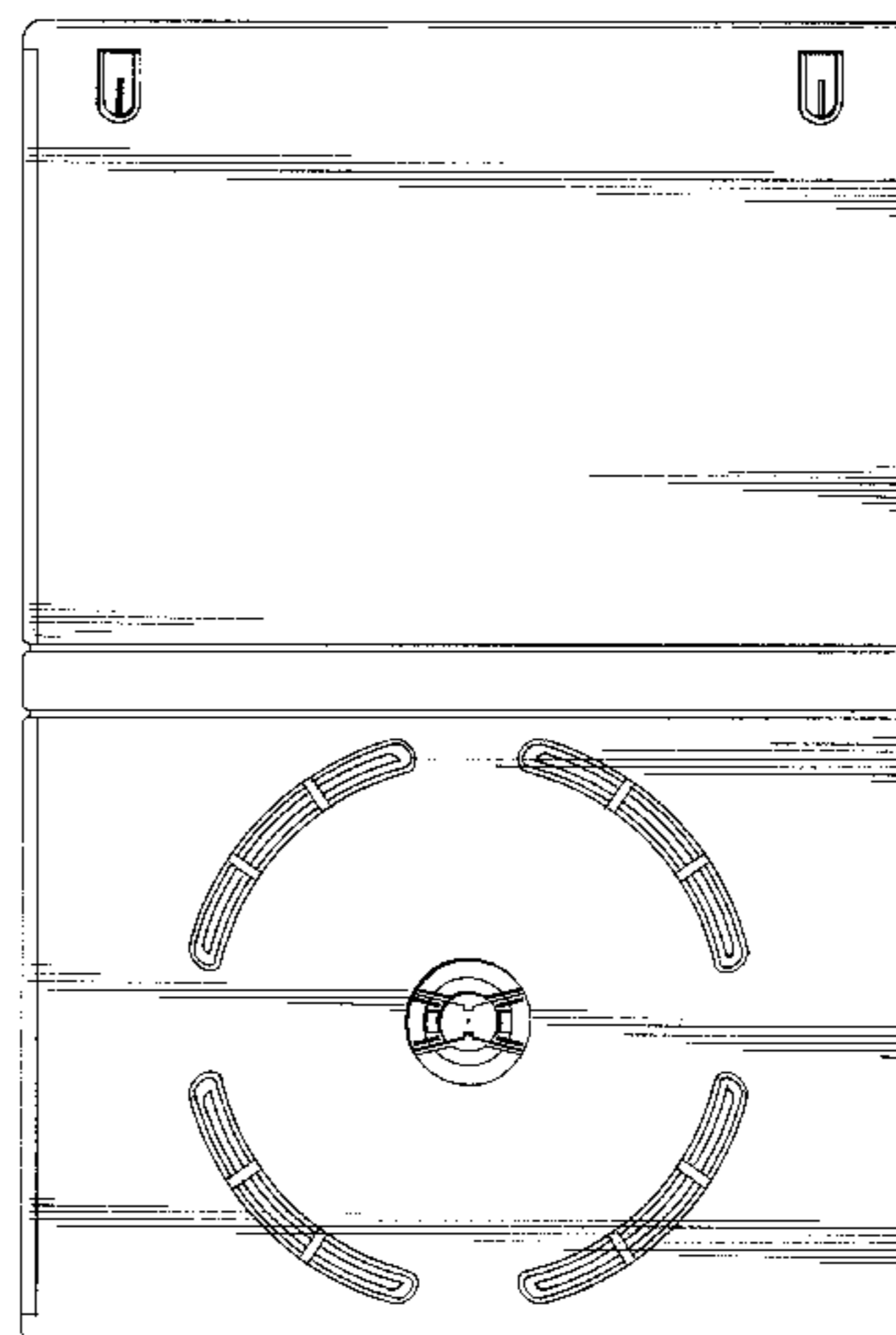
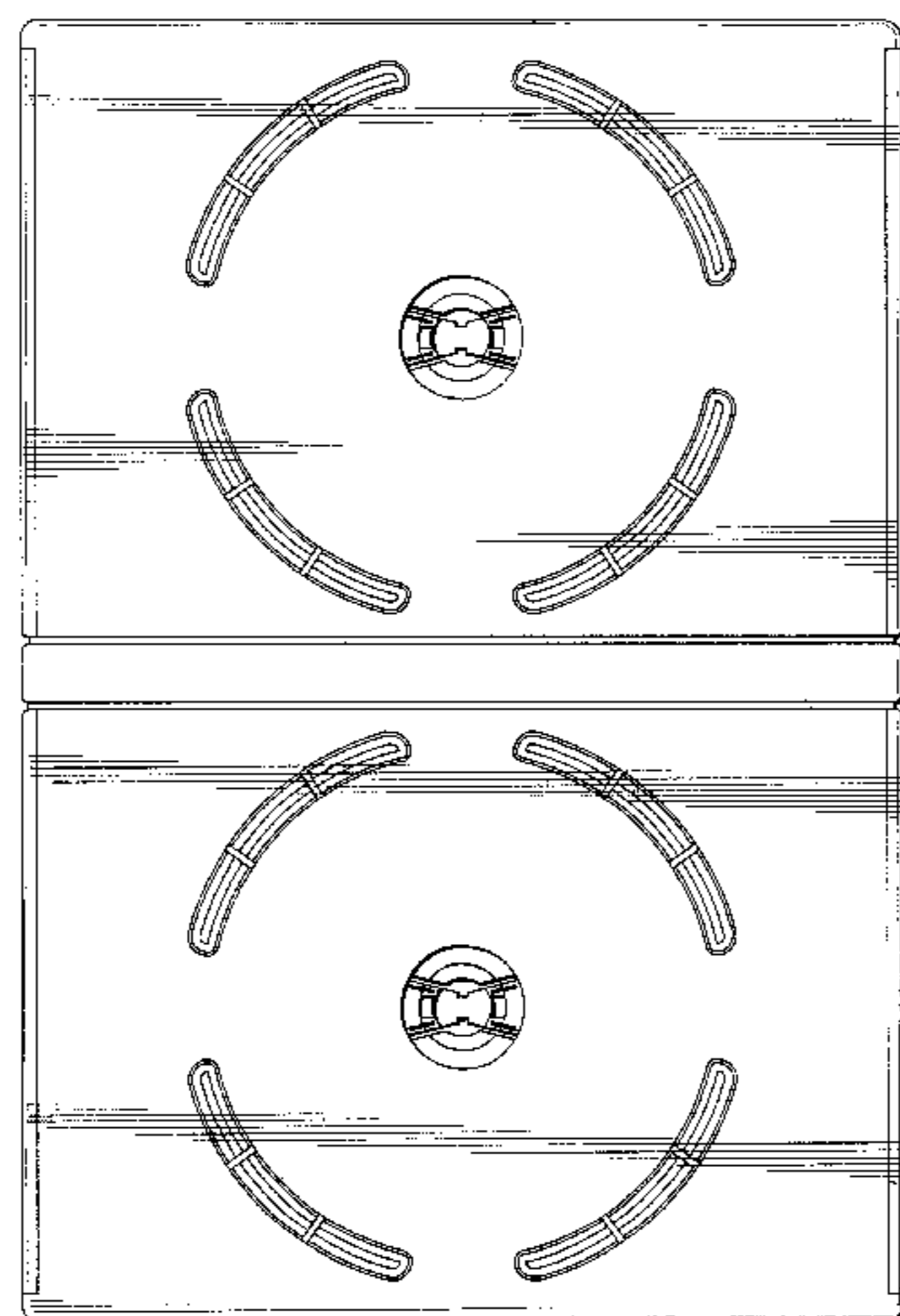

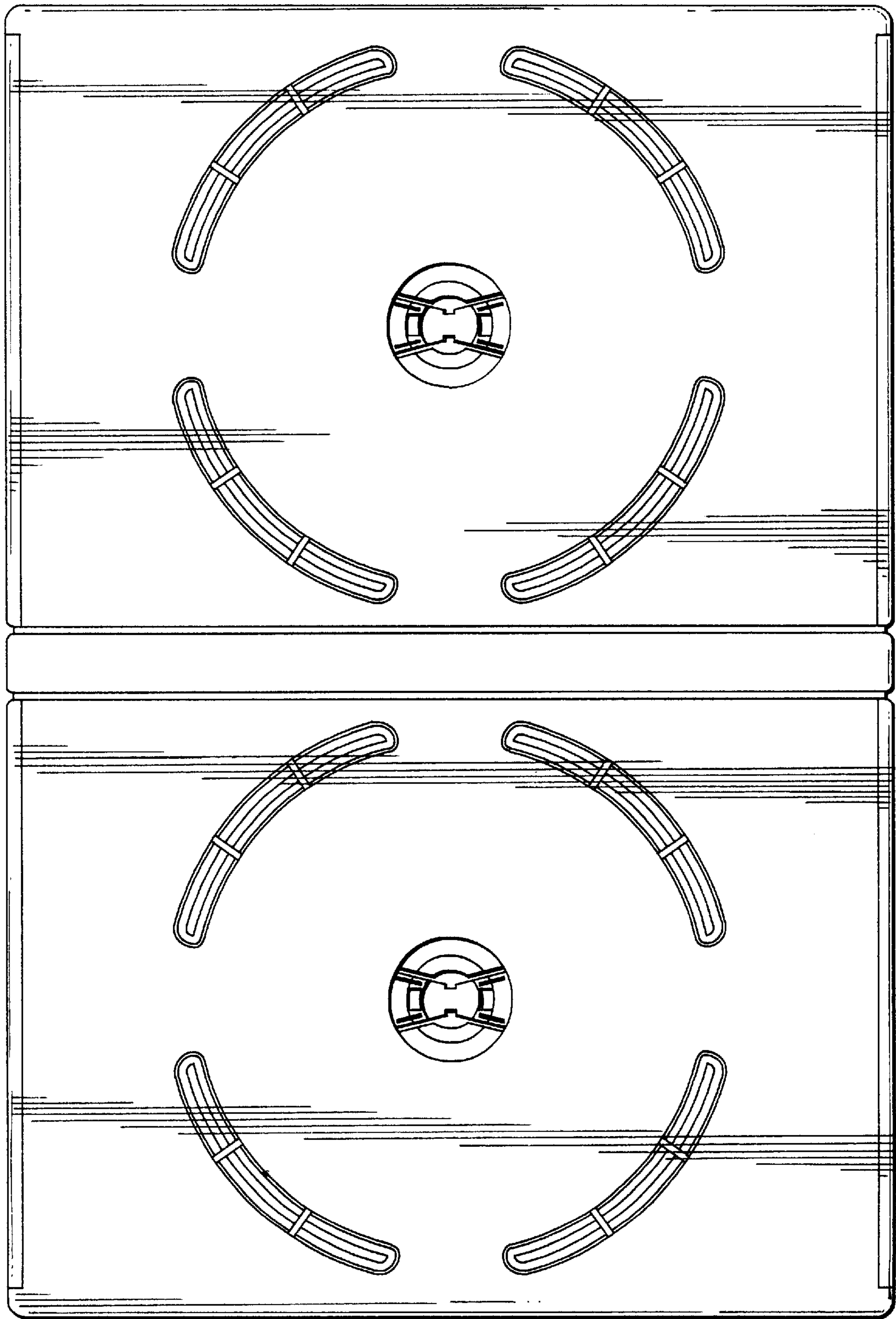

FIG. 1

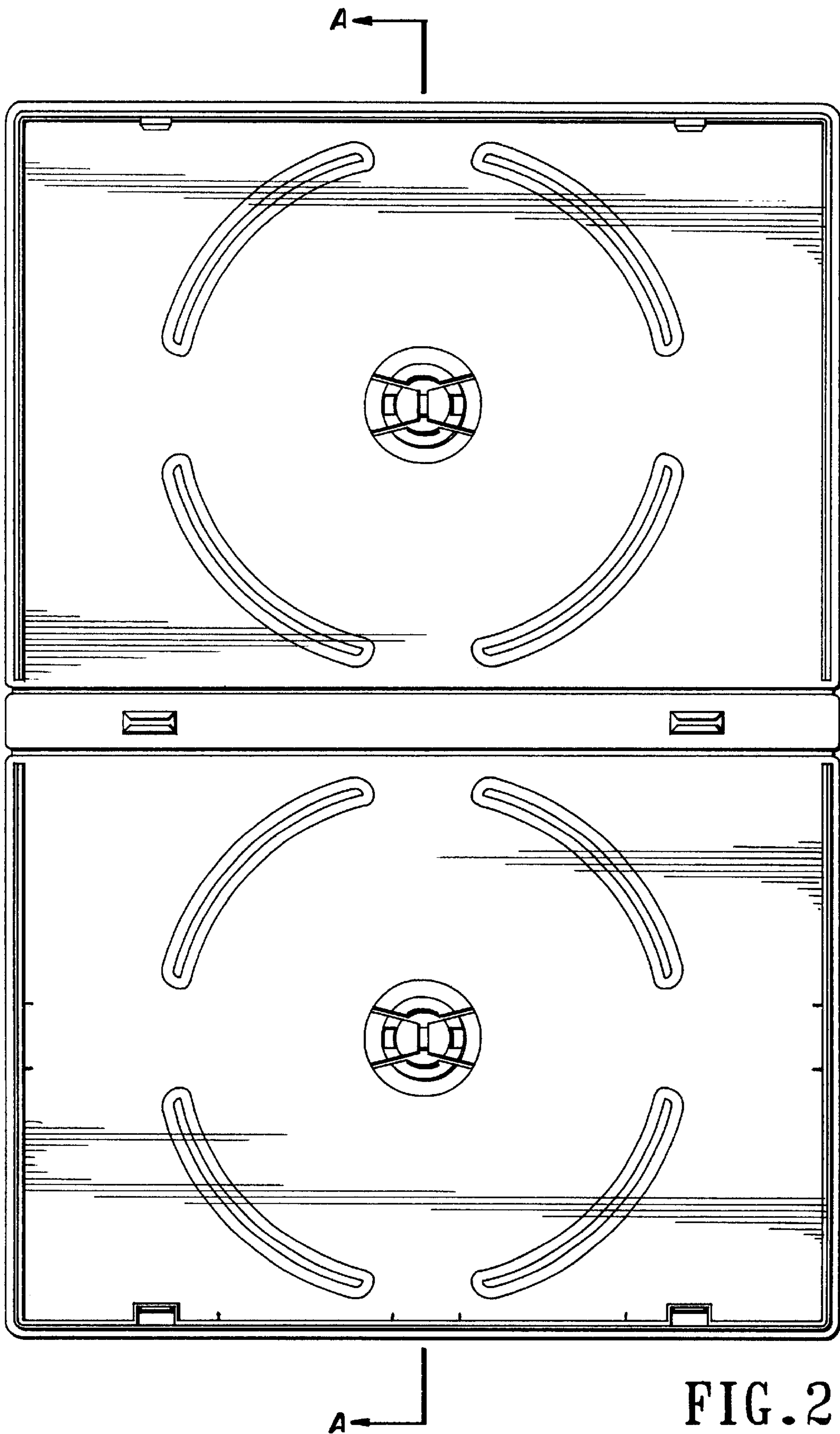

FIG. 2

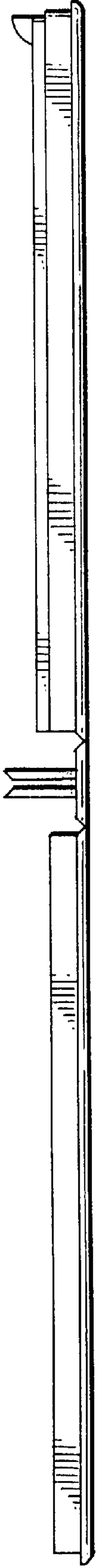

FIG. 3

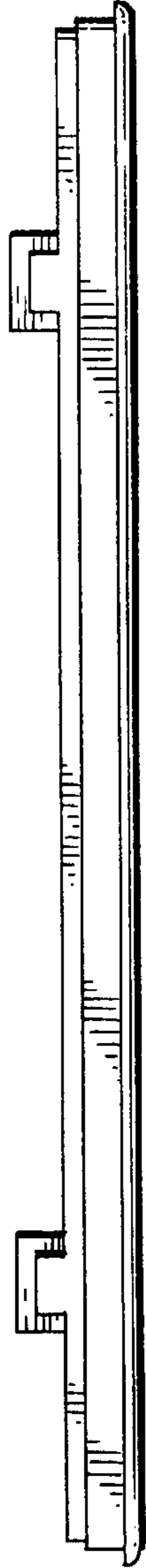

FIG. 4

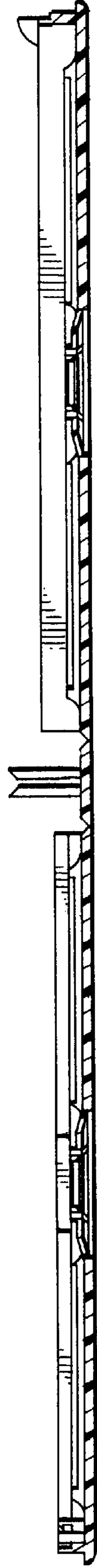

FIG. 8

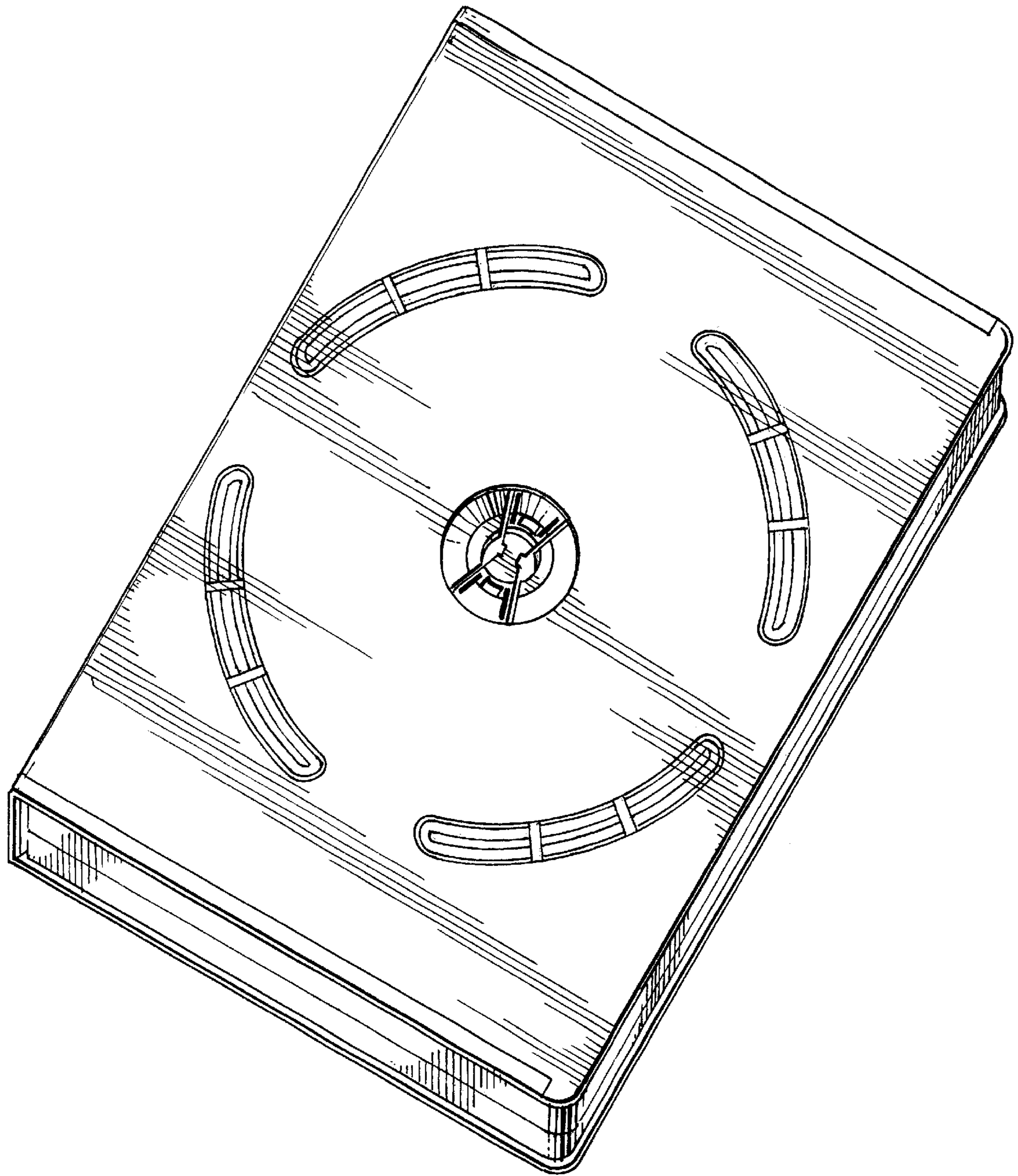

FIG. 5

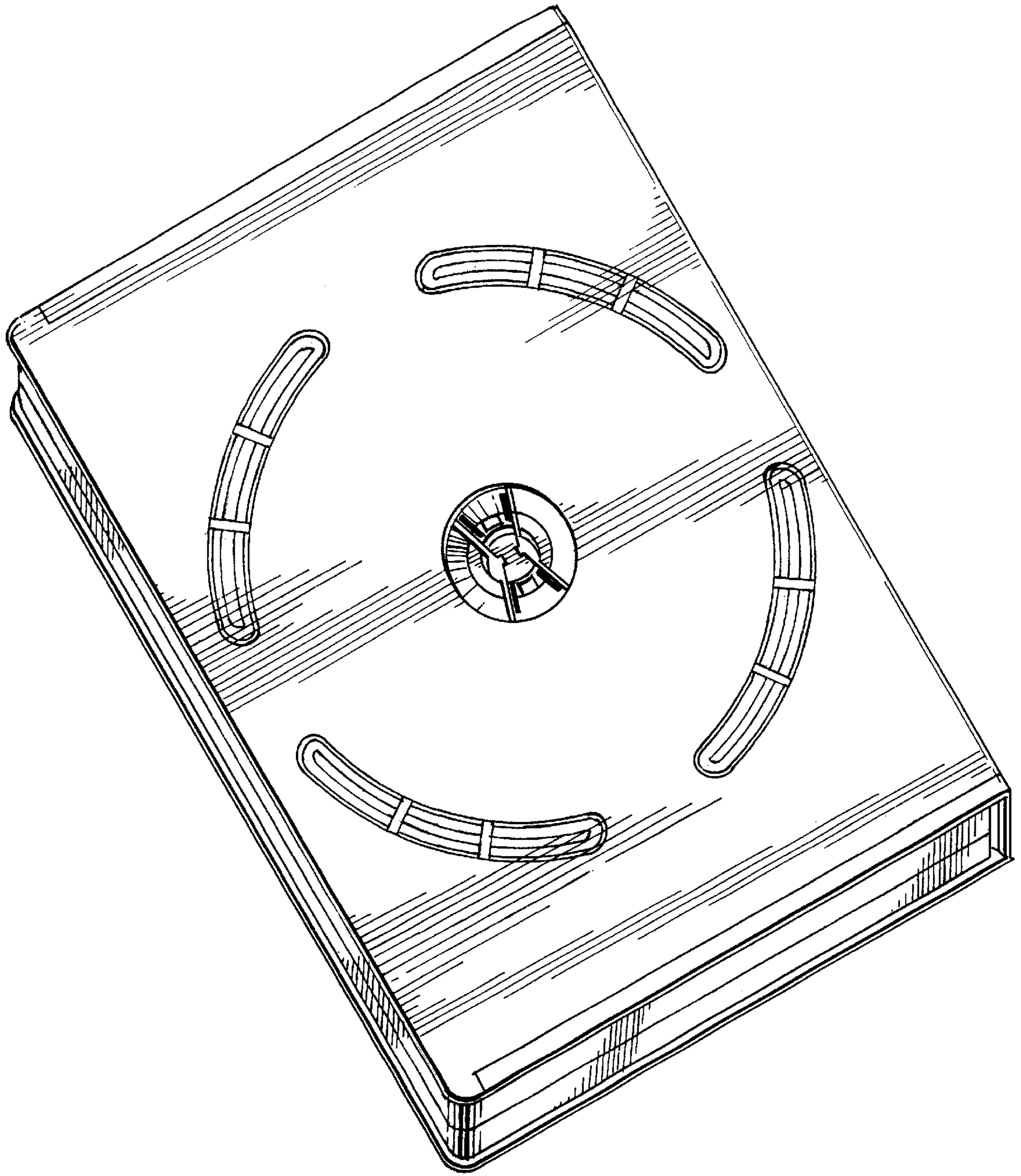

FIG. 6

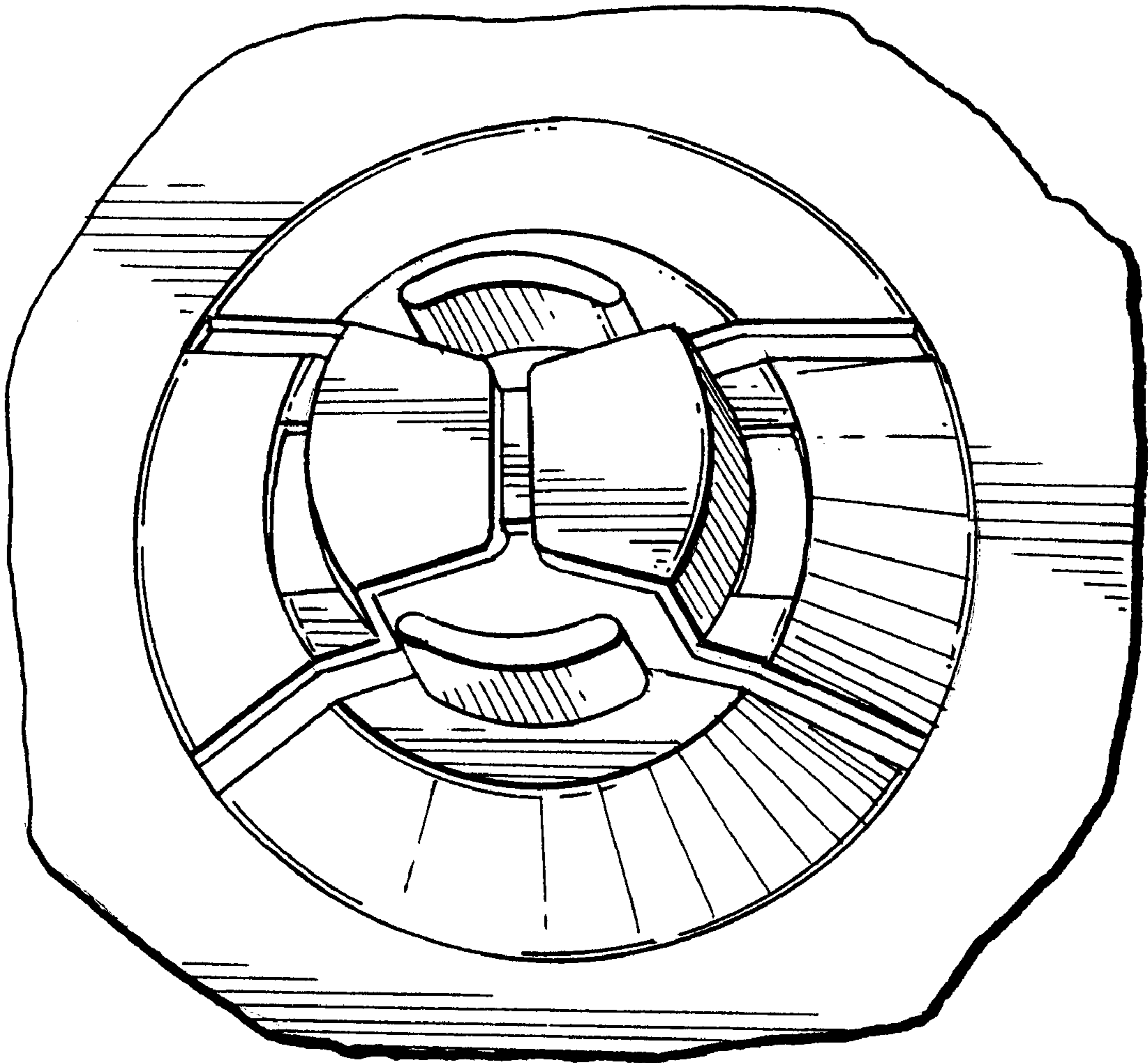

FIG. 7

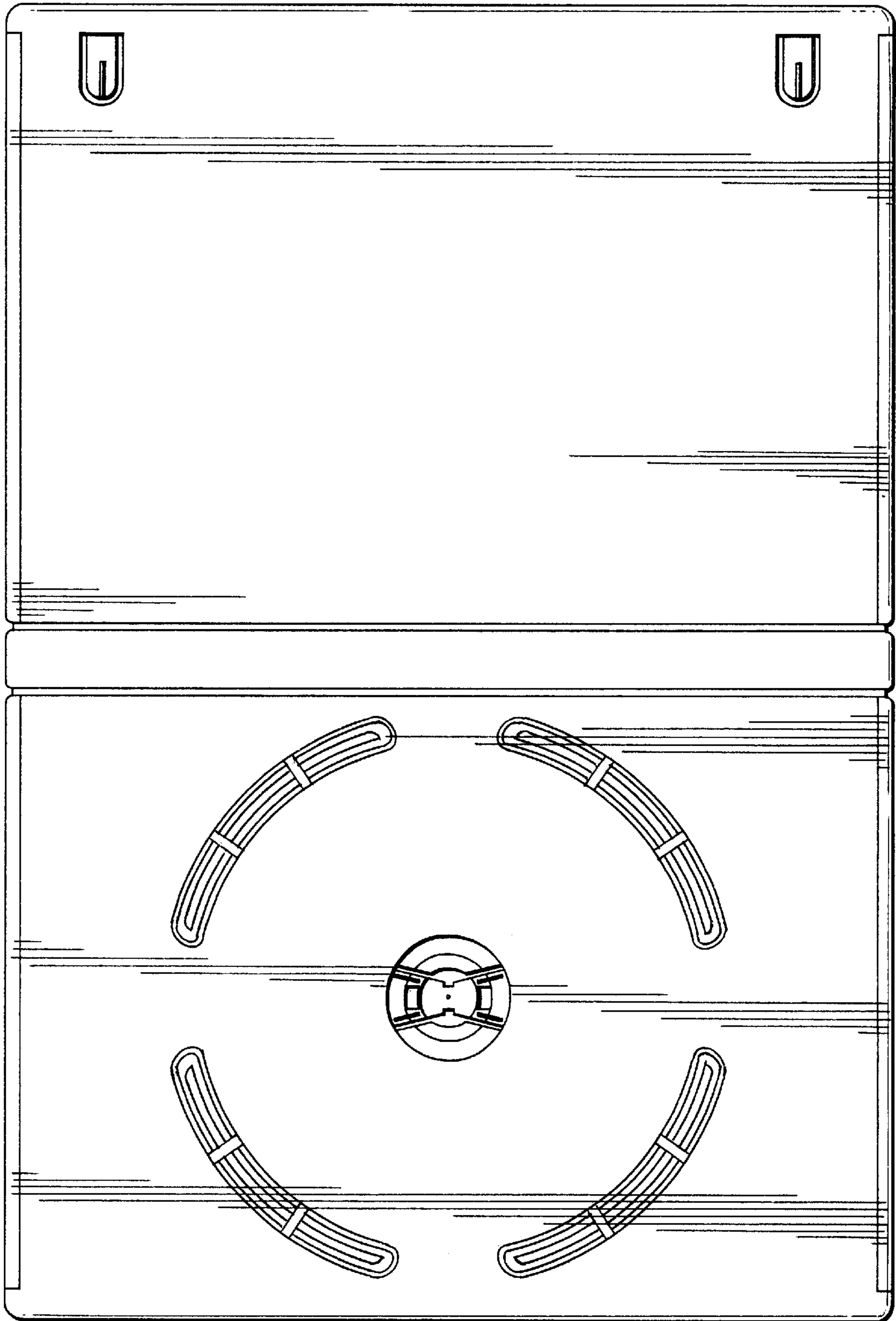

FIG. 9



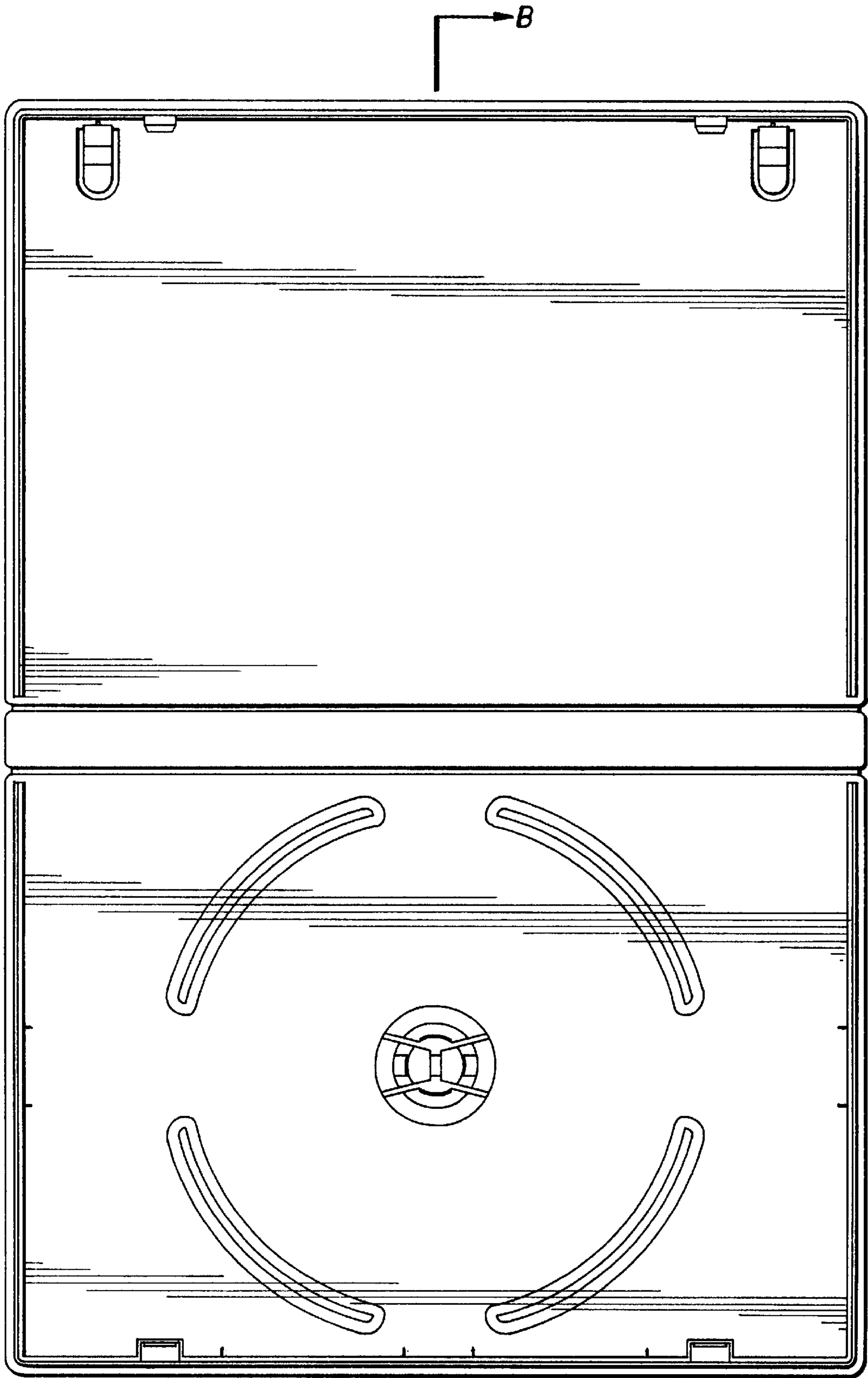

FIG. 10

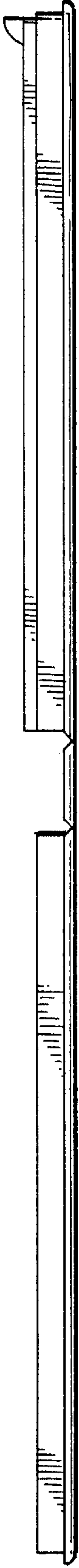

FIG. 11



FIG. 12



FIG. 16

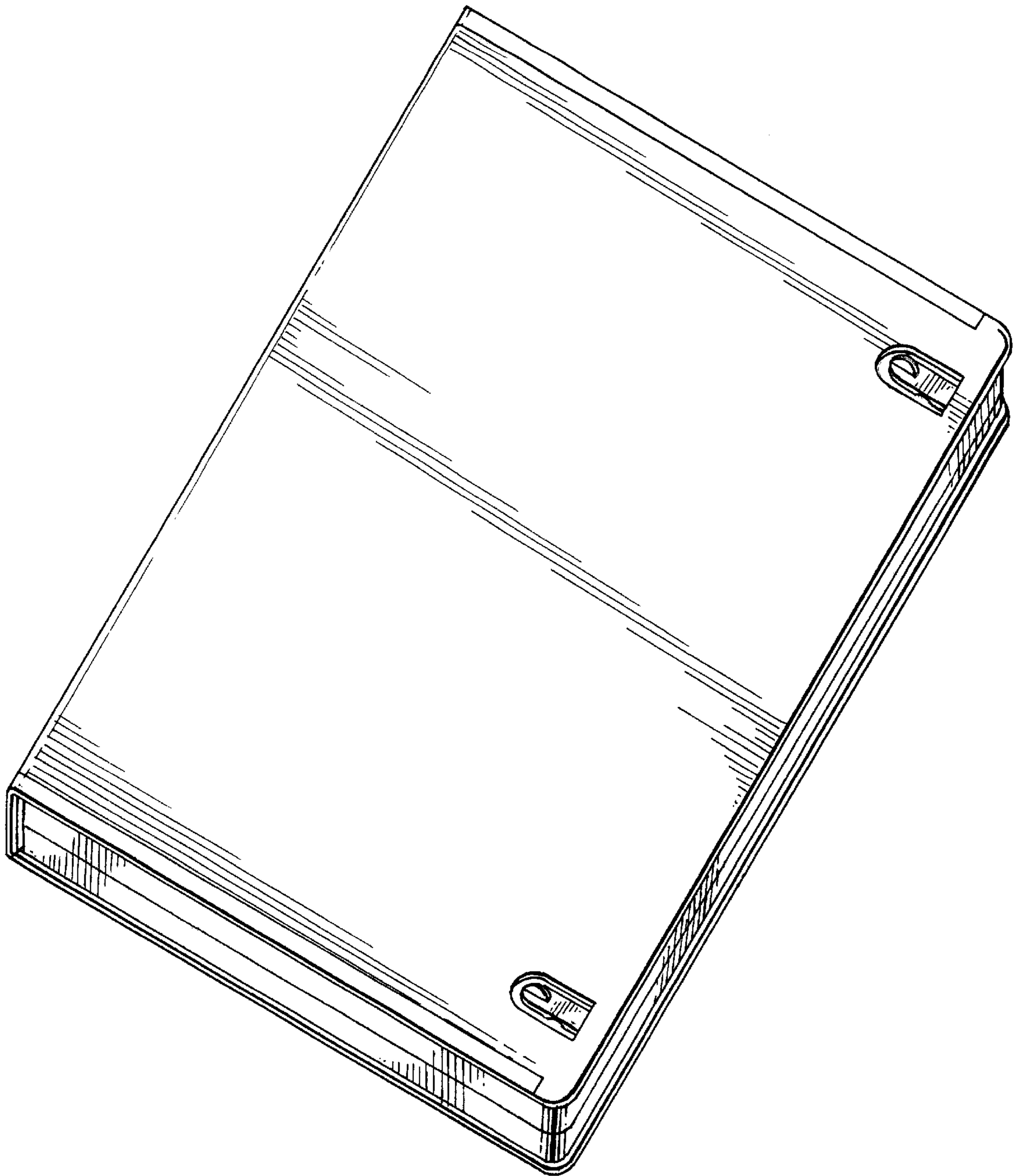

FIG. 13

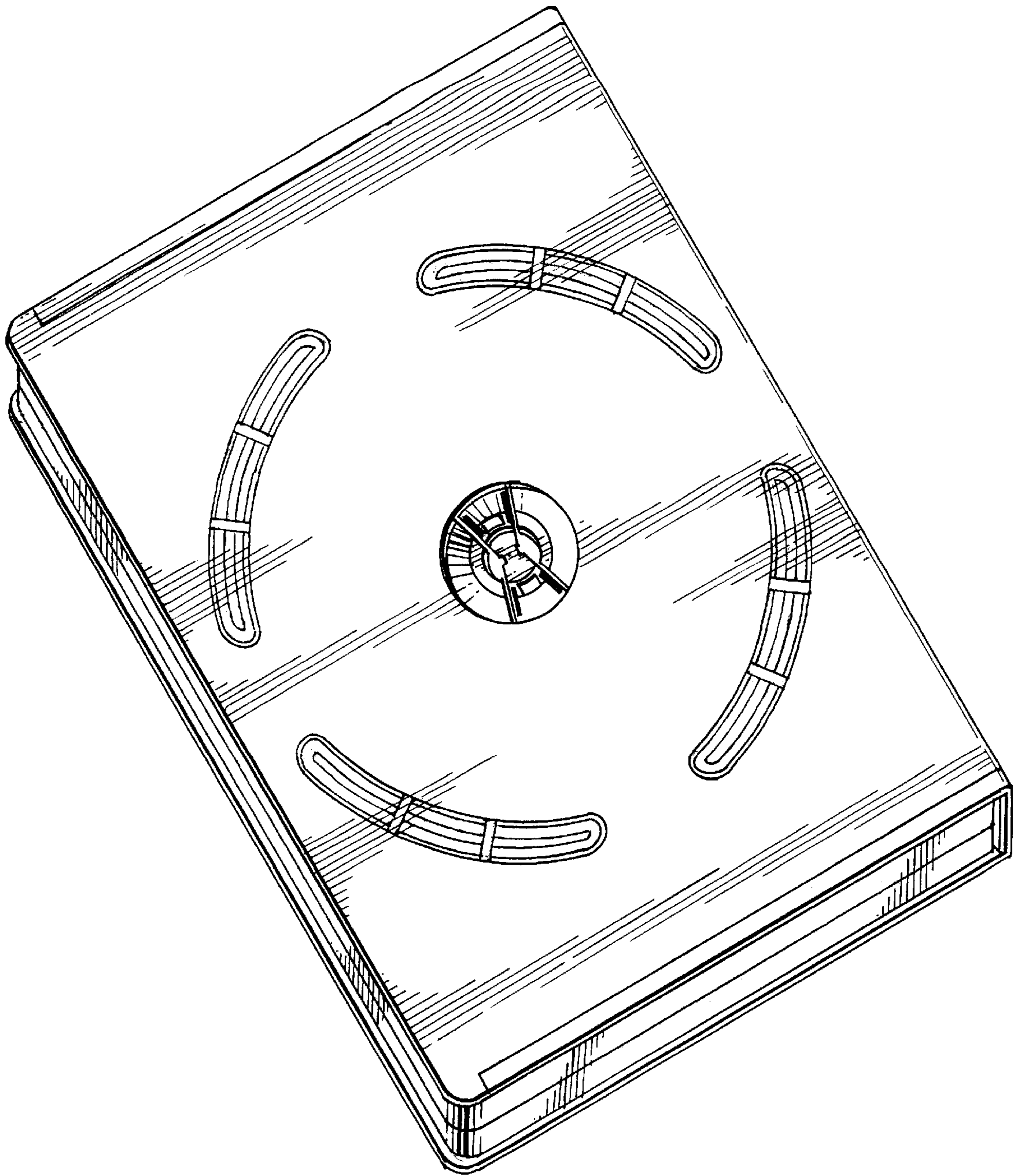

FIG. 14

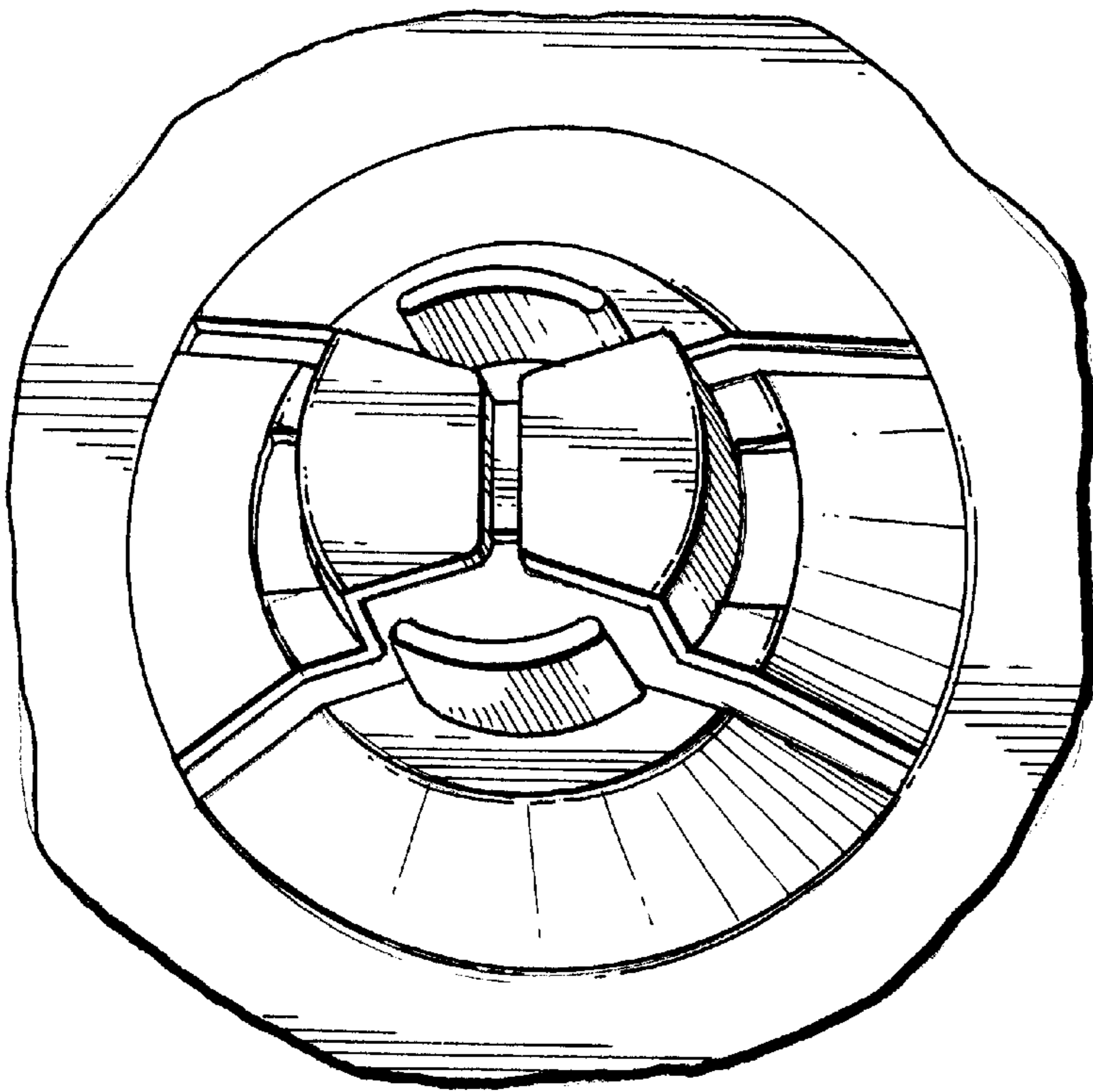

FIG. 15