



US00D470635S

(12) **United States Design Patent**
Choi

(10) **Patent No.:** **US D470,635 S**

(45) **Date of Patent:** **** Feb. 18, 2003**

- (54) **IRON**
- (75) Inventor: **Lung Wai Choi, Kowloon (HK)**
- (73) Assignee: **Goodway Electrical Co. Ltd., Kowloon (HK)**
- (**) Term: **14 Years**
- (21) Appl. No.: **29/119,208**
- (22) Filed: **Feb. 25, 2000**
- (30) **Foreign Application Priority Data**
 - Dec. 3, 1999 (GB) 2088572
 - Dec. 3, 1999 (GB) 2088573
- (51) **LOC (7) Cl.** **07-05**
- (52) **U.S. Cl.** **D32/70**
- (58) **Field of Search** D32/68, 69, 70;
38/77.1, 77.2, 77.3, 77.4, 77.5, 74, 69,
88; 219/245, 254, 273, 275

- D406,933 S 3/1999 Leverrier
- D413,005 S 8/1999 Taylor
- D415,865 S 10/1999 Littmann et al.
- D416,656 S 11/1999 Sadler
- D419,274 S 1/2000 Choi
- D423,162 S 4/2000 Sugimoto et al.
- D425,278 S 5/2000 Yang
- D427,403 S 6/2000 Gudefin
- D428,541 S 7/2000 Bas
- D432,751 S 10/2000 Gudefin
- D434,197 S 11/2000 Perko et al.
- D435,157 S 12/2000 Naft et al.
- D443,743 S * 6/2001 Edwards et al. D32/70

* cited by examiner

Primary Examiner—Cynthia E. Ramirez
(74) *Attorney, Agent, or Firm*—Christensen O'Connor Johnson Kindness PLLC

(57) **CLAIM**

I claim the ornamental design for an iron, as shown and described.

- (56) **References Cited**
 - U.S. PATENT DOCUMENTS**
 - D291,616 S 8/1987 Henny
 - D361,184 S 8/1995 Casuso Fuente
 - D362,944 S * 10/1995 Sham et al. D32/70
 - D368,348 S 3/1996 Loomis et al.
 - D369,005 S 4/1996 Stützer et al.
 - D376,234 S 12/1996 Hensel et al.
 - D386,863 S 11/1997 Lin
 - D389,627 S 1/1998 Stützer et al.
 - D401,706 S 11/1998 Gudefin

DESCRIPTION

FIG. 1 is a perspective view of my new iron;
FIG. 2 is a top view thereof;
FIG. 3 is a bottom view thereof;
FIG. 4 is a front view thereof;
FIG. 5 is a rear view thereof;
FIG. 6 is a left side view thereof; and,
FIG. 7 is a right side view thereof.

1 Claim, 6 Drawing Sheets

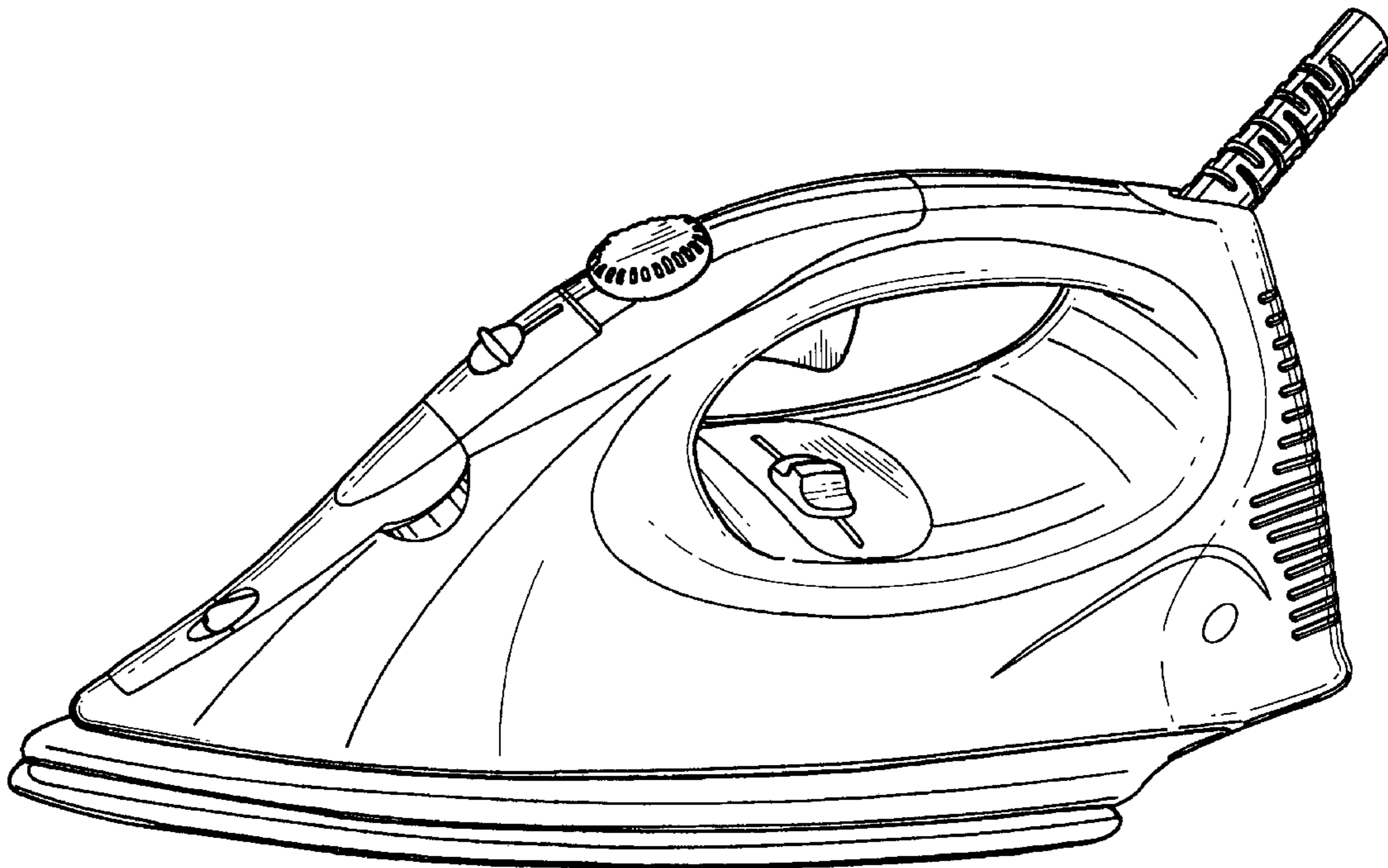

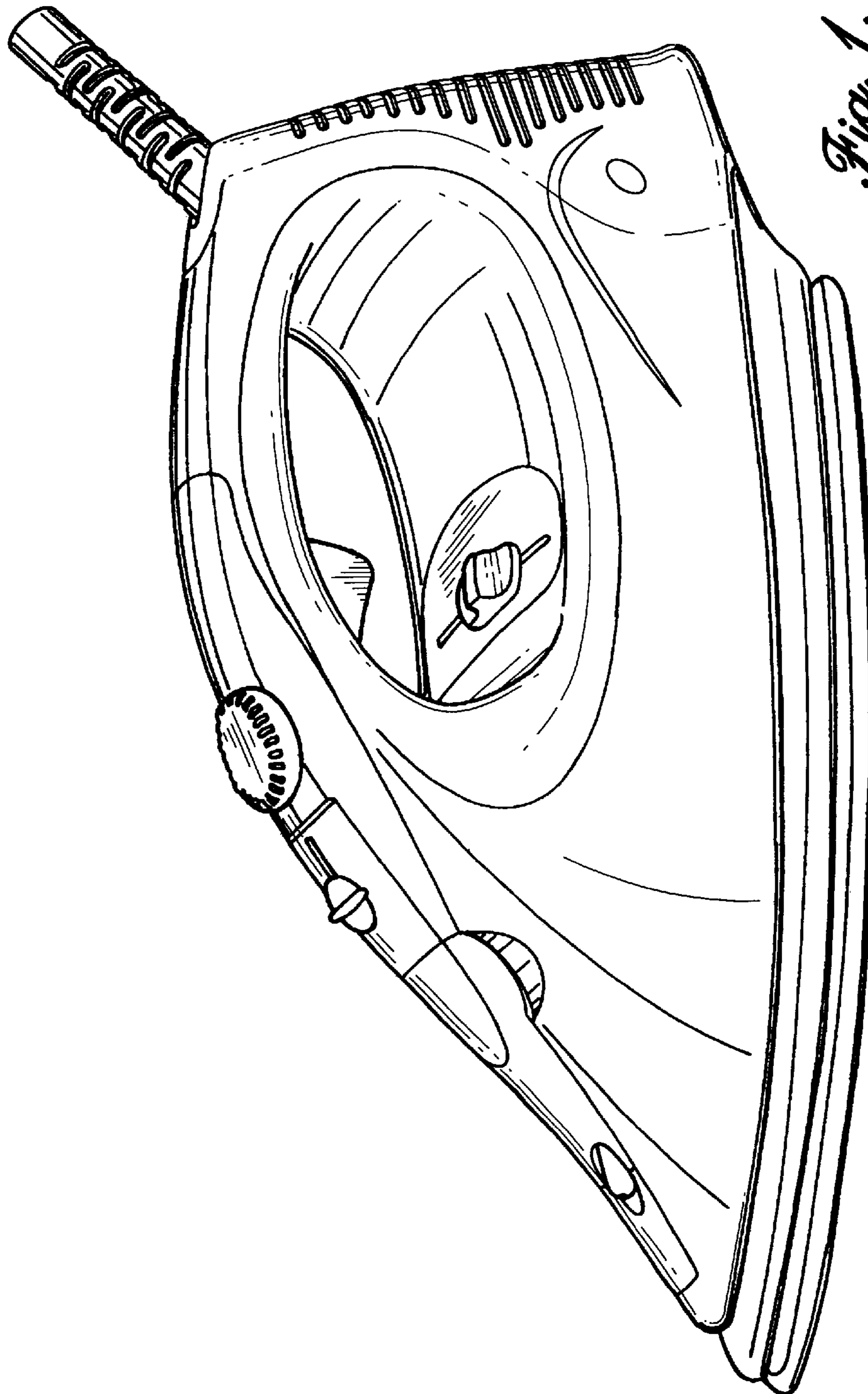
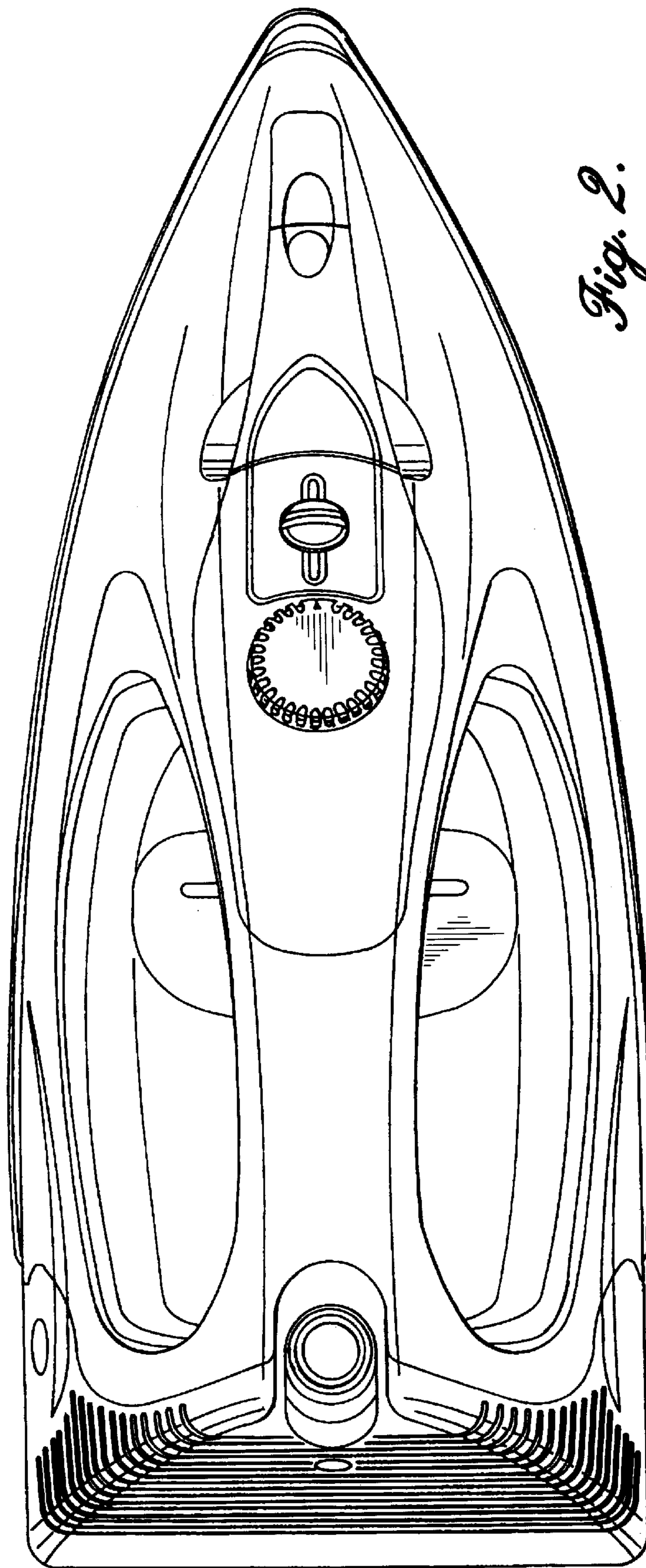

Fig. 1.



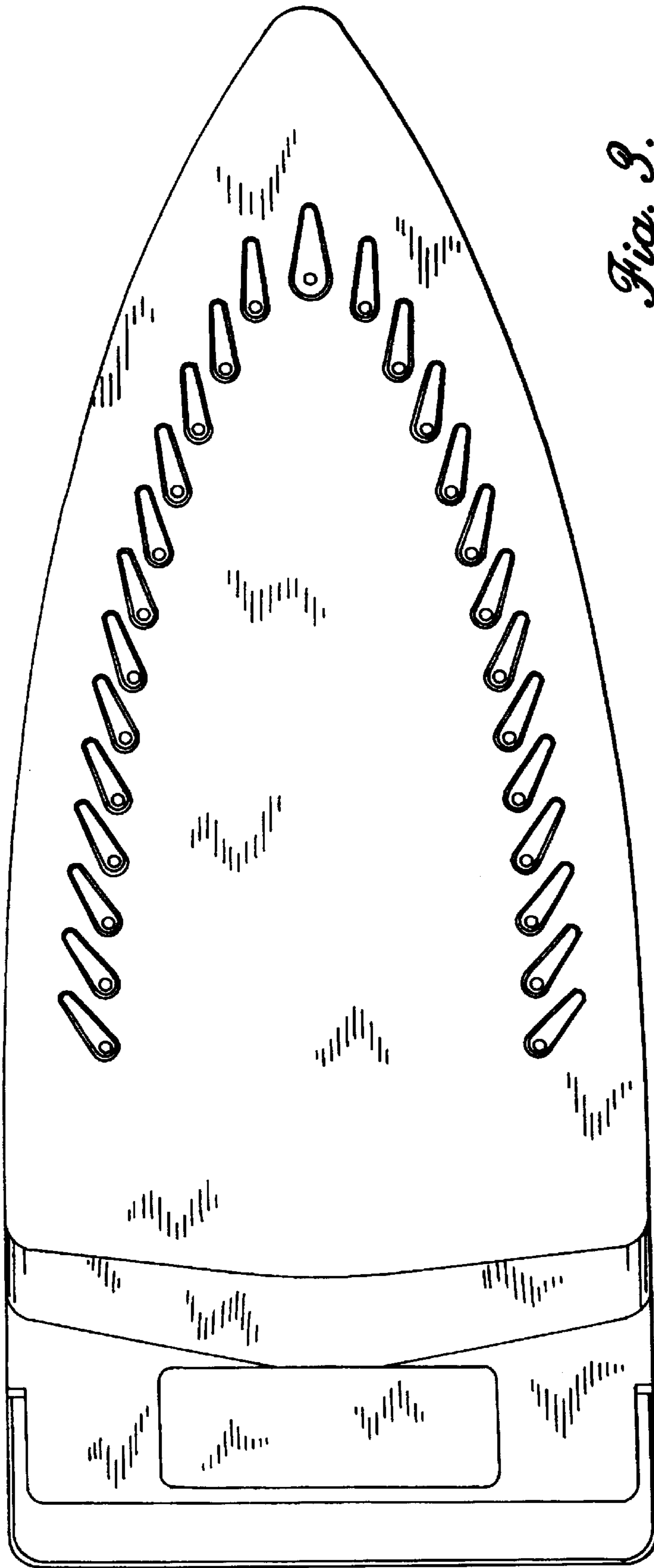

Fig. 3.

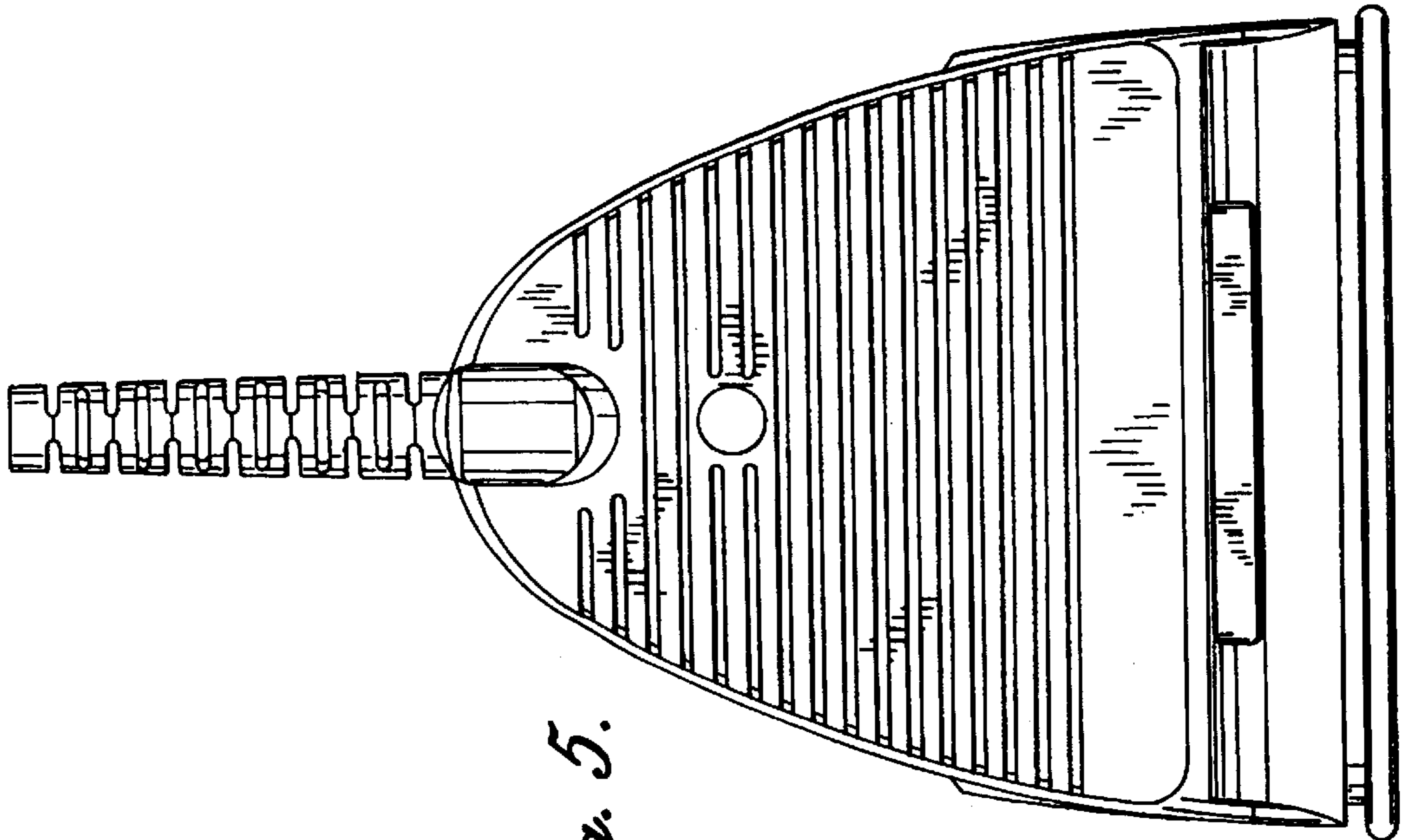

Fig. 5.

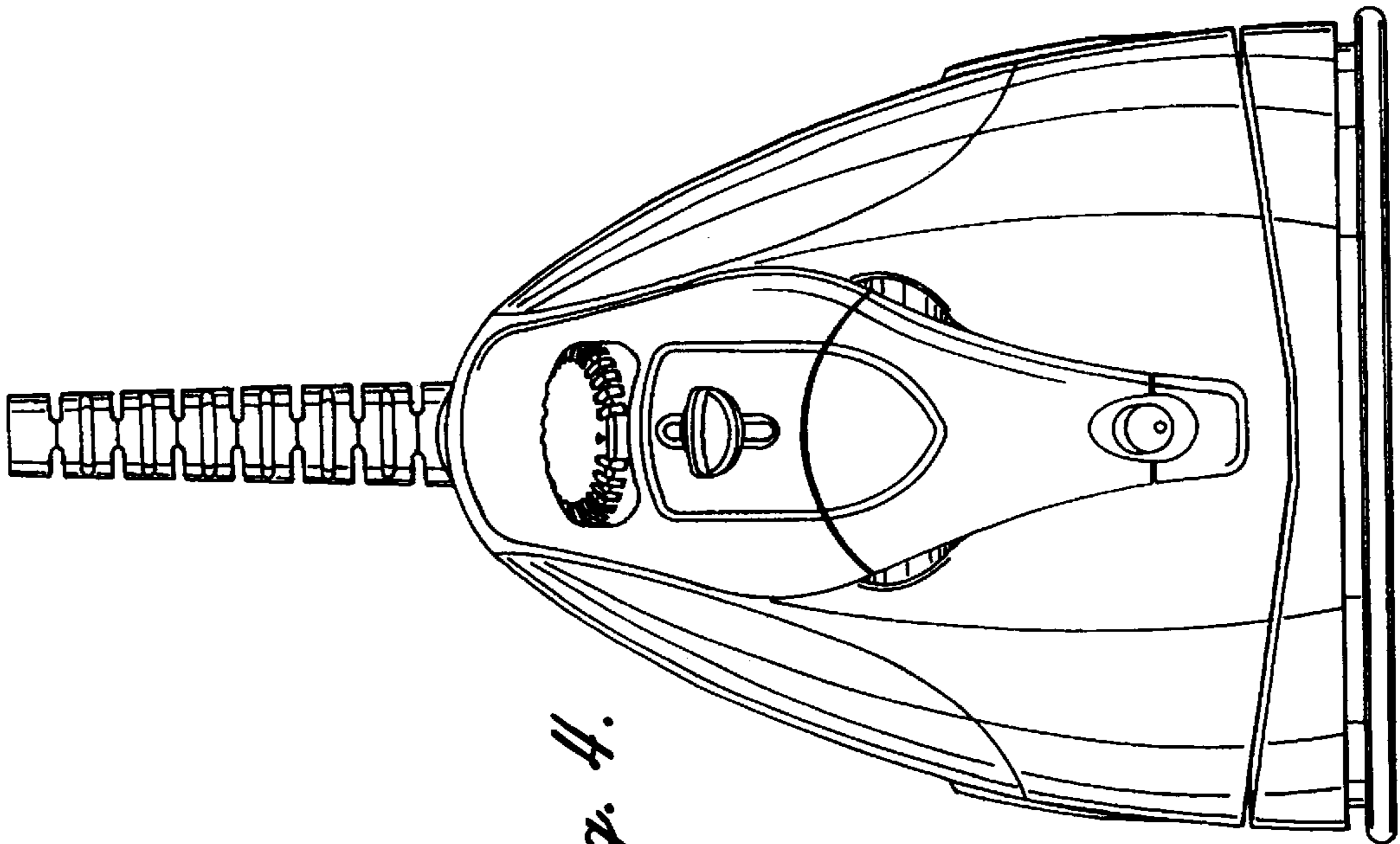

Fig. 4.

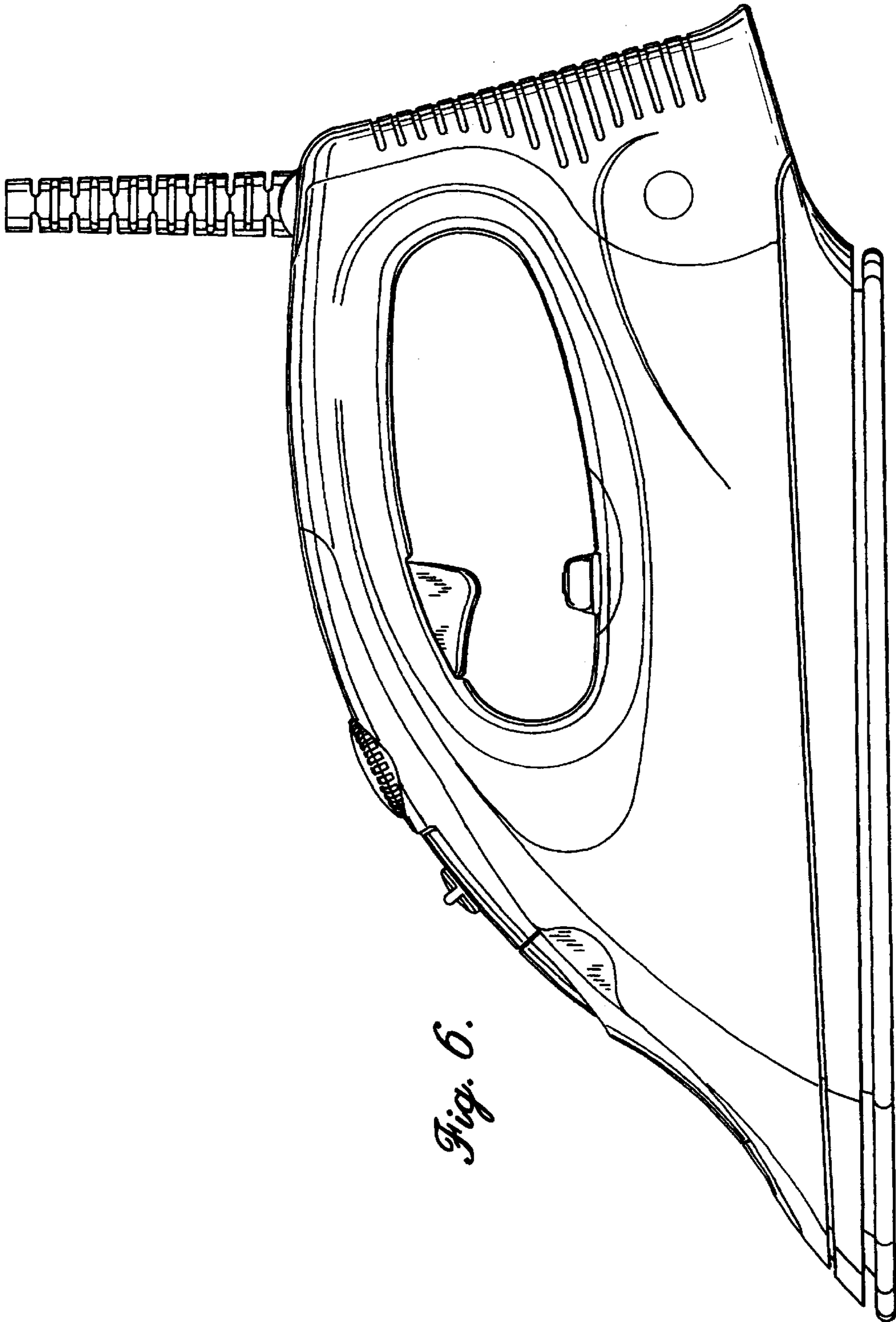

Fig. 6.

