



US00D470538S

(12) **United States Design Patent**
Morgan

(10) **Patent No.:** **US D470,538 S**

(45) **Date of Patent:** **** Feb. 18, 2003**

(54) **GAME BOARD**

(76) Inventor: **David P. Morgan**, Box 190, Dundurn,
Saskatchewan (CA), S0K 1K0

(**) Term: **14 Years**

(21) Appl. No.: **29/156,327**

(22) Filed: **Feb. 28, 2002**

(51) **LOC (7) Cl.** **21-01**

(52) **U.S. Cl.** **D21/335; D21/364**

(58) **Field of Search** **D21/334-368;**
273/236-288

(56) **References Cited**

U.S. PATENT DOCUMENTS

D270,921 S	*	10/1983	Morgan	D21/335
4,515,370 A	*	5/1985	Garcia	273/258
D450,779 S	*	11/2001	Ko	D21/335

* cited by examiner

Primary Examiner—Sandra L. Morris

(74) *Attorney, Agent, or Firm*—Ryan W. Dupuis

(57) **CLAIM**

The ornamental design for a game board, as shown and described.

DESCRIPTION

FIG. 1 is a top plan view of the game board unfolded with a handle of the game board shown separated.

FIG. 2 is a side elevational view from the lower side of FIG. 1.

FIG. 3 is a side elevational view from the upper side of FIG. 1.

FIG. 4 is an underside plan view of the game board unfolded.

FIG. 5 is a left side elevational view of FIG. 1.

FIG. 6 is a right side elevational view of FIG. 1.

FIG. 7 is a top plan view of the game board with one panel folded and the handle attached thereto.

FIG. 8 is a top plan view of the game board with two panels folded and the handle attached thereto.

FIG. 9 is a top plan view of the game board with three panels folded and the handle attached thereto.

FIG. 10 is a side elevational view of FIG. 9.

FIG. 11 is an isometric view of the game board of FIG. 9 shown with three panels folded and the handle attached thereto.

FIG. 12 is an isometric view of FIG. 8 shown with two panels folded and the handle separated; and,

FIG. 13 is an isometric view of FIG. 1.

1 Claim, 6 Drawing Sheets

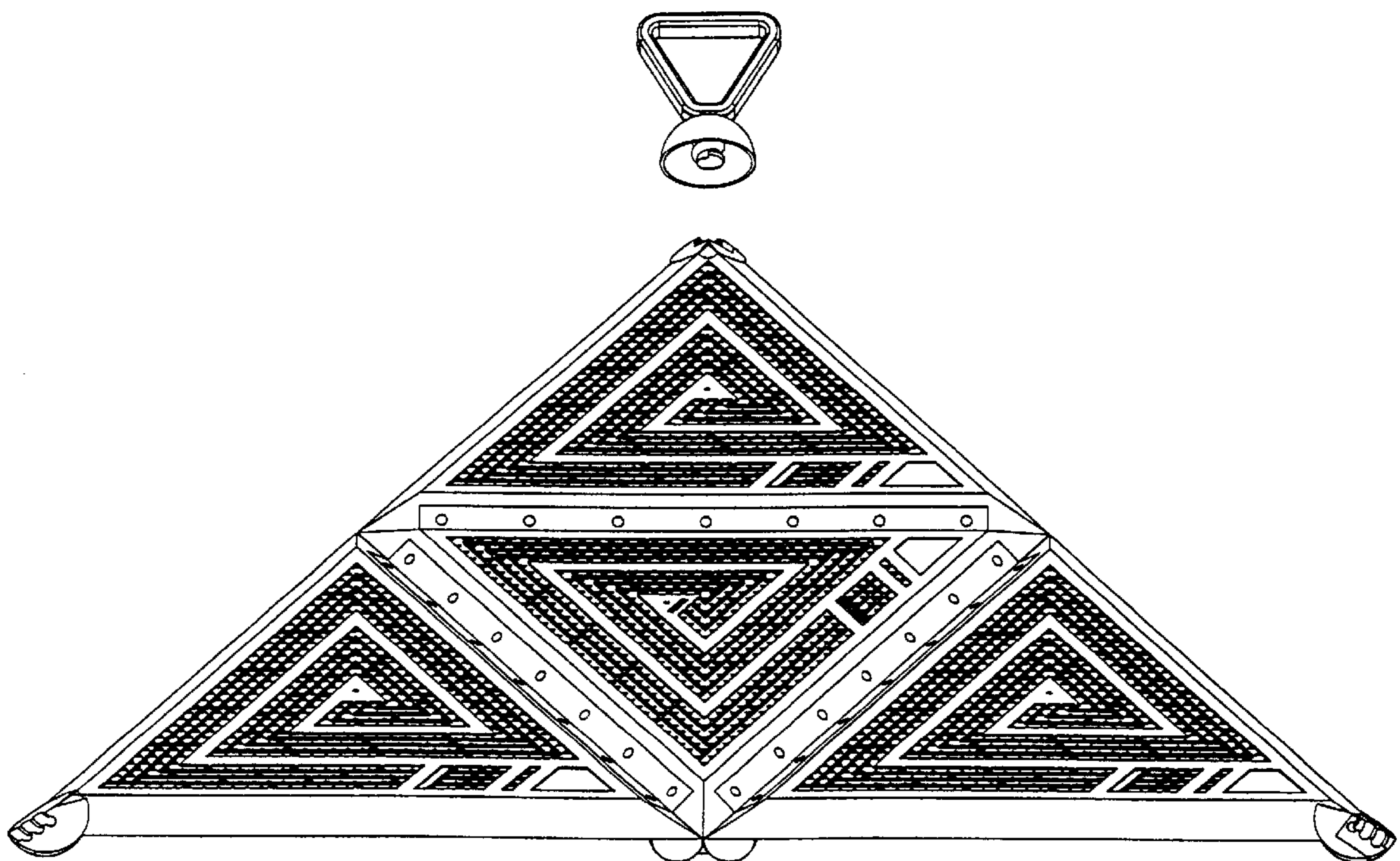

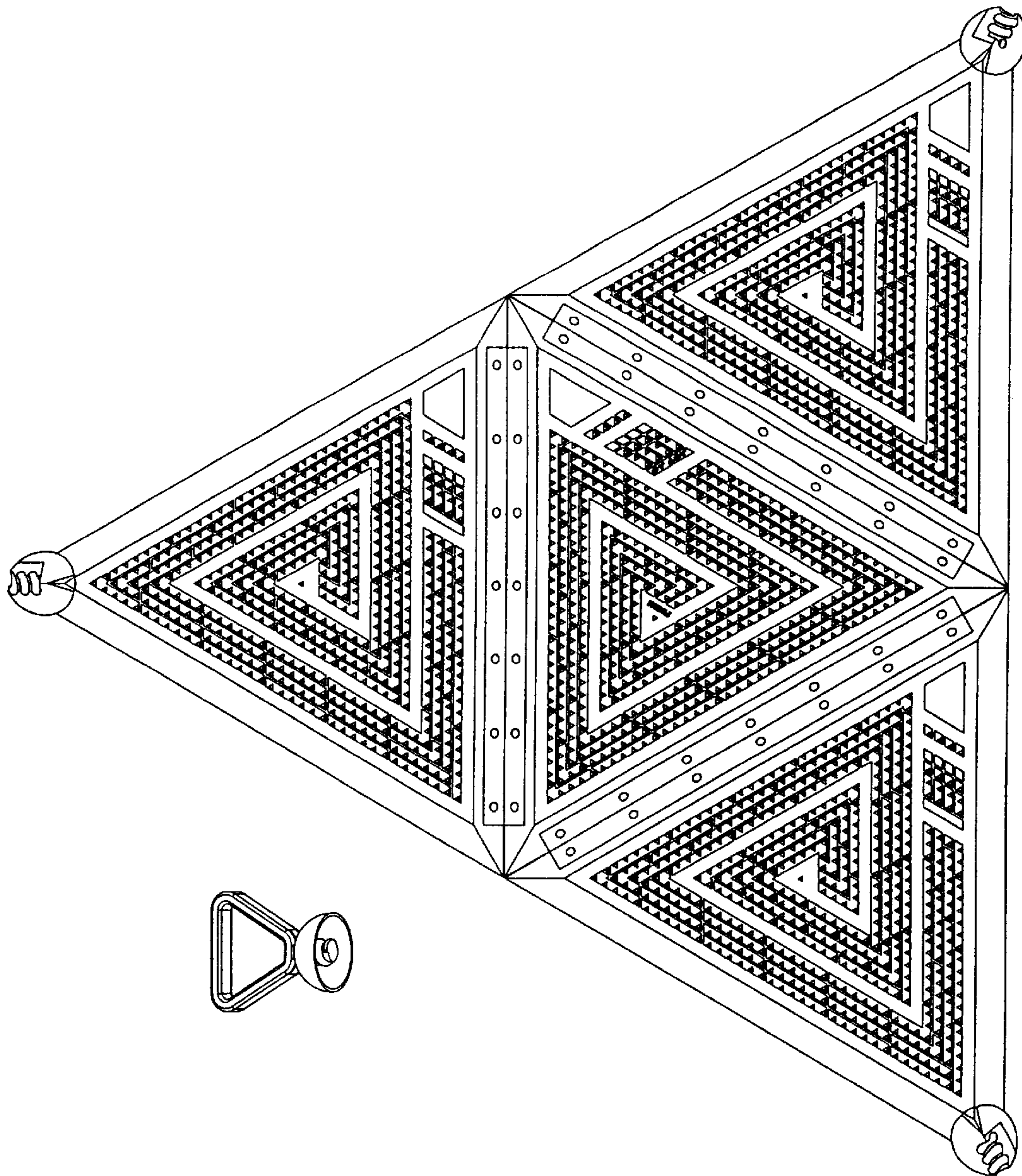

FIG. 1

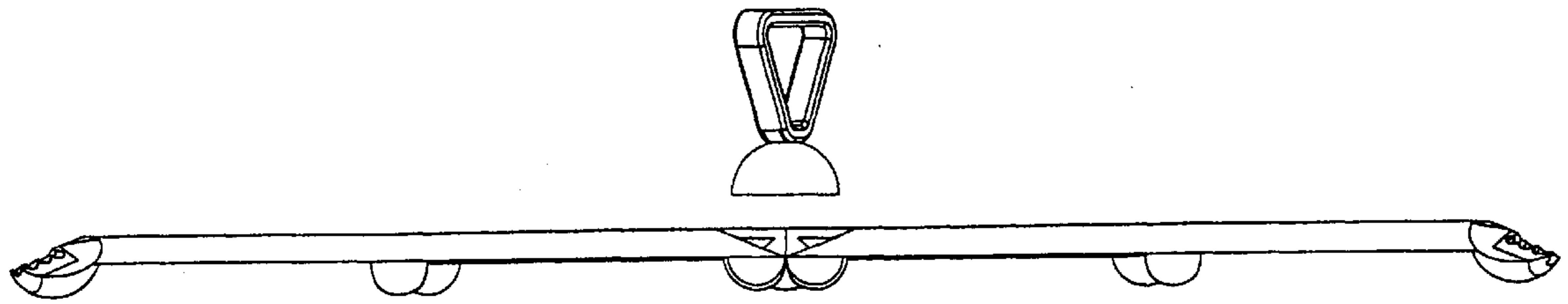

FIG. 2

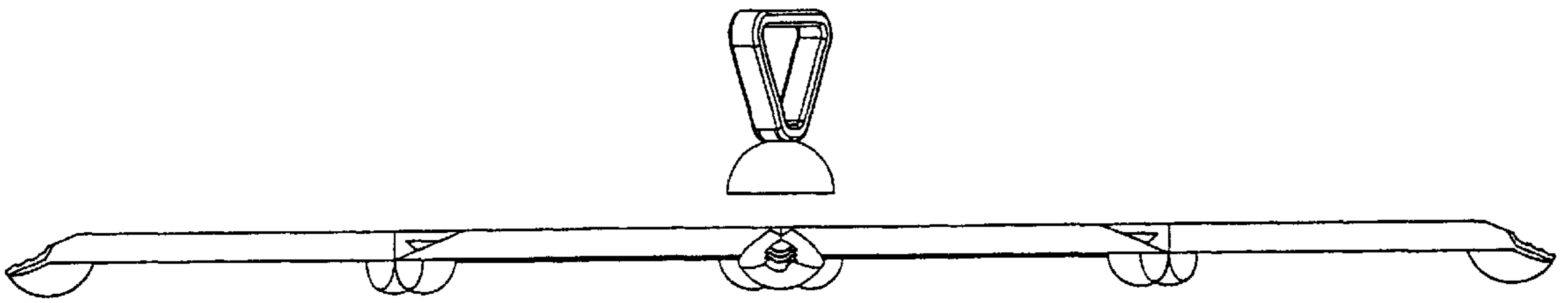

FIG. 3

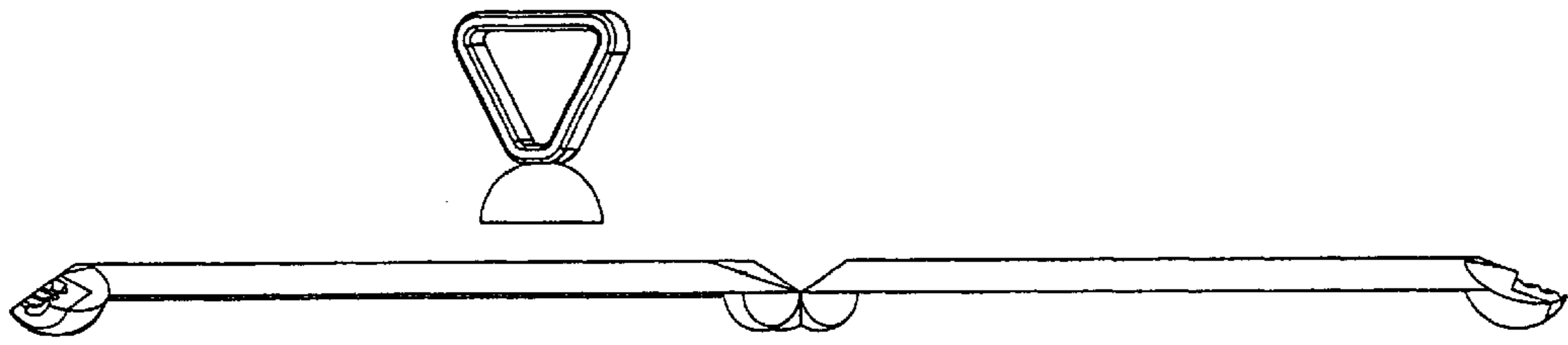

FIG. 5

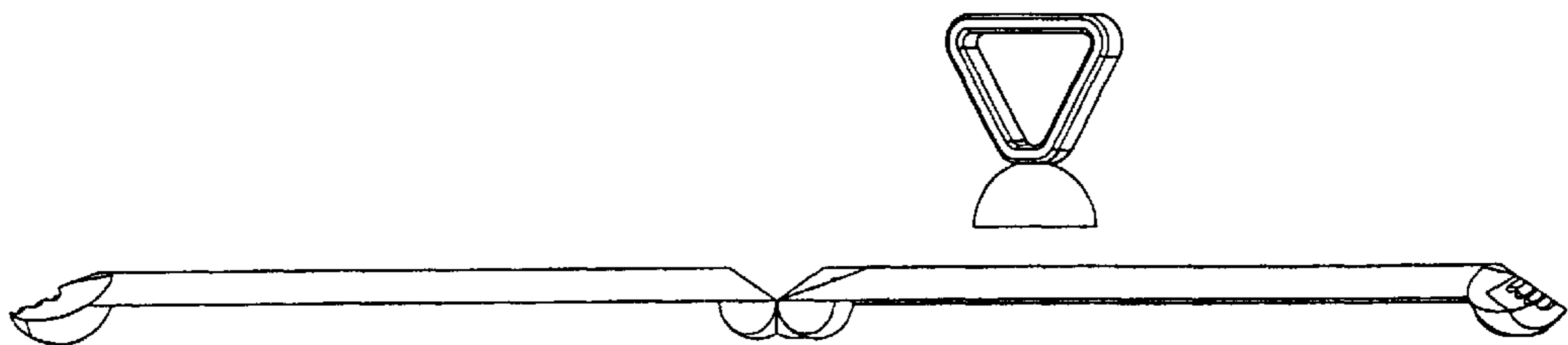

FIG. 6

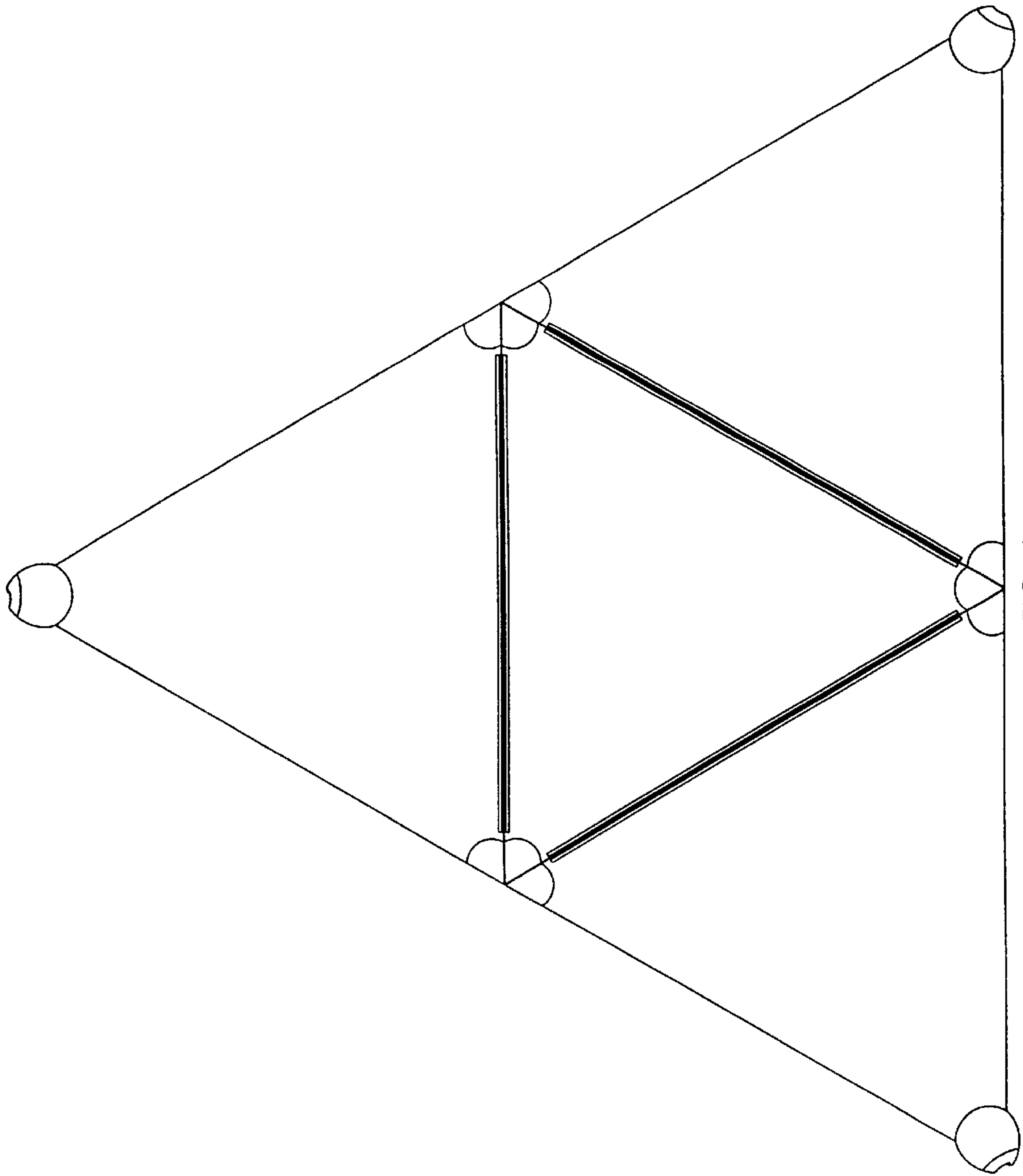

FIG. 4

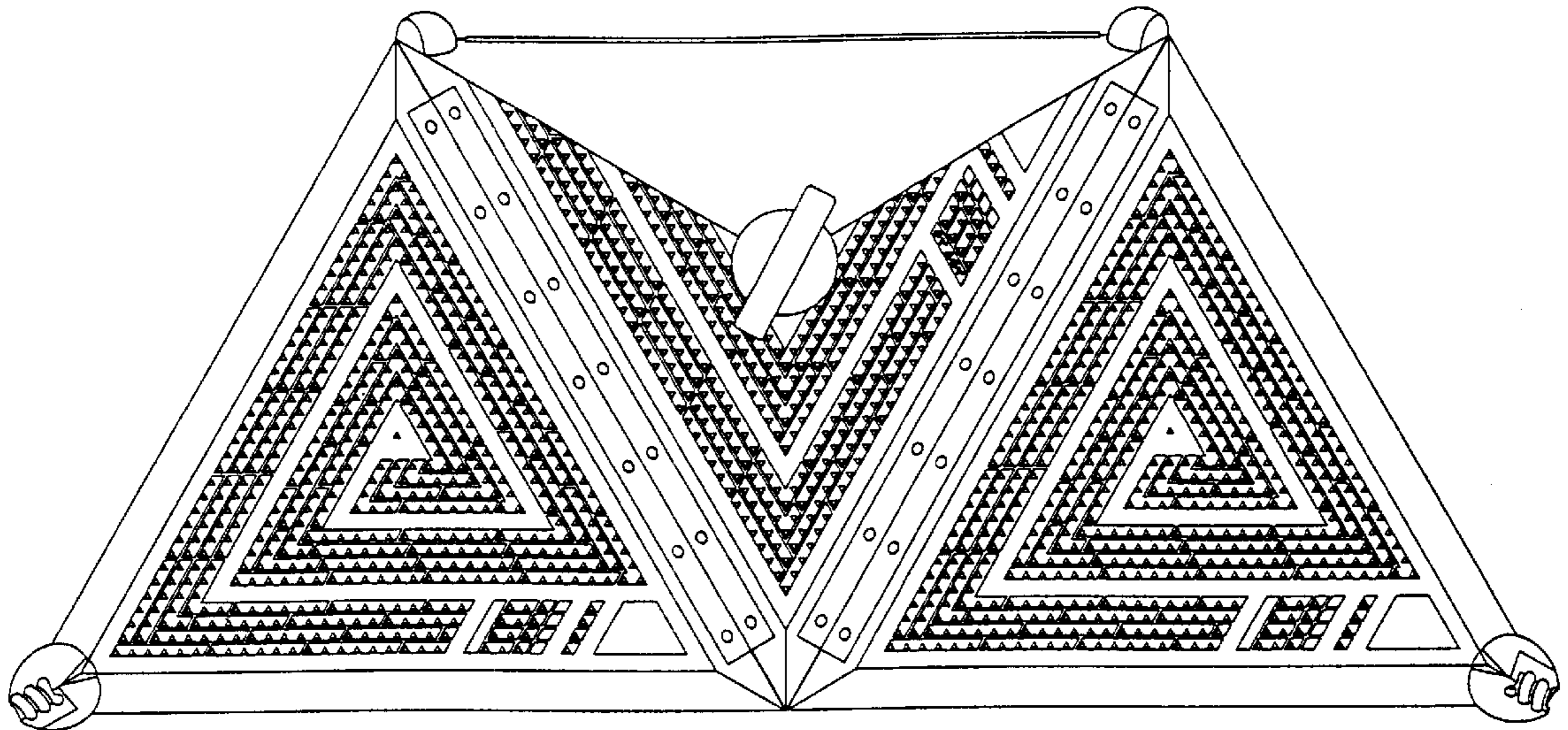

FIG. 7

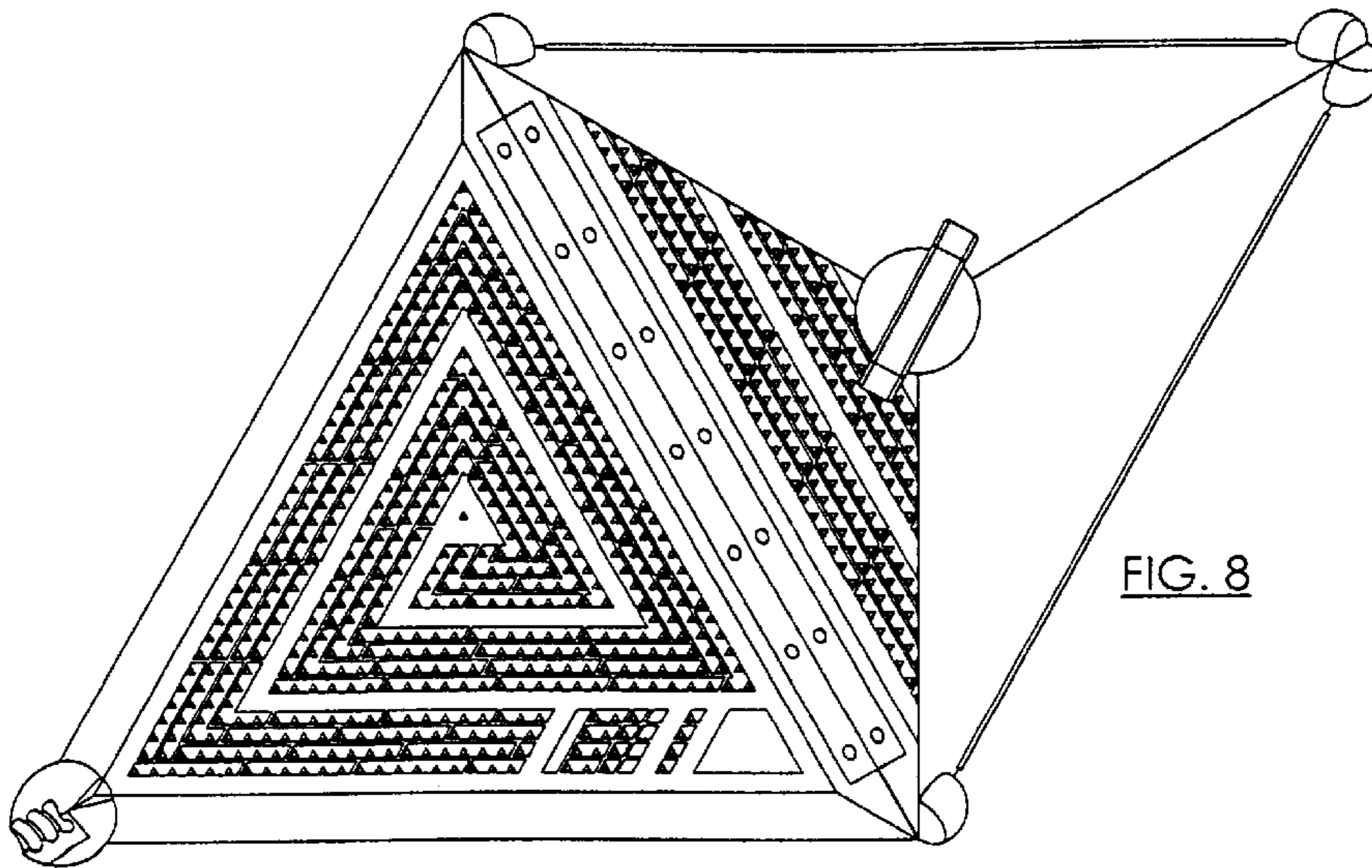

FIG. 8

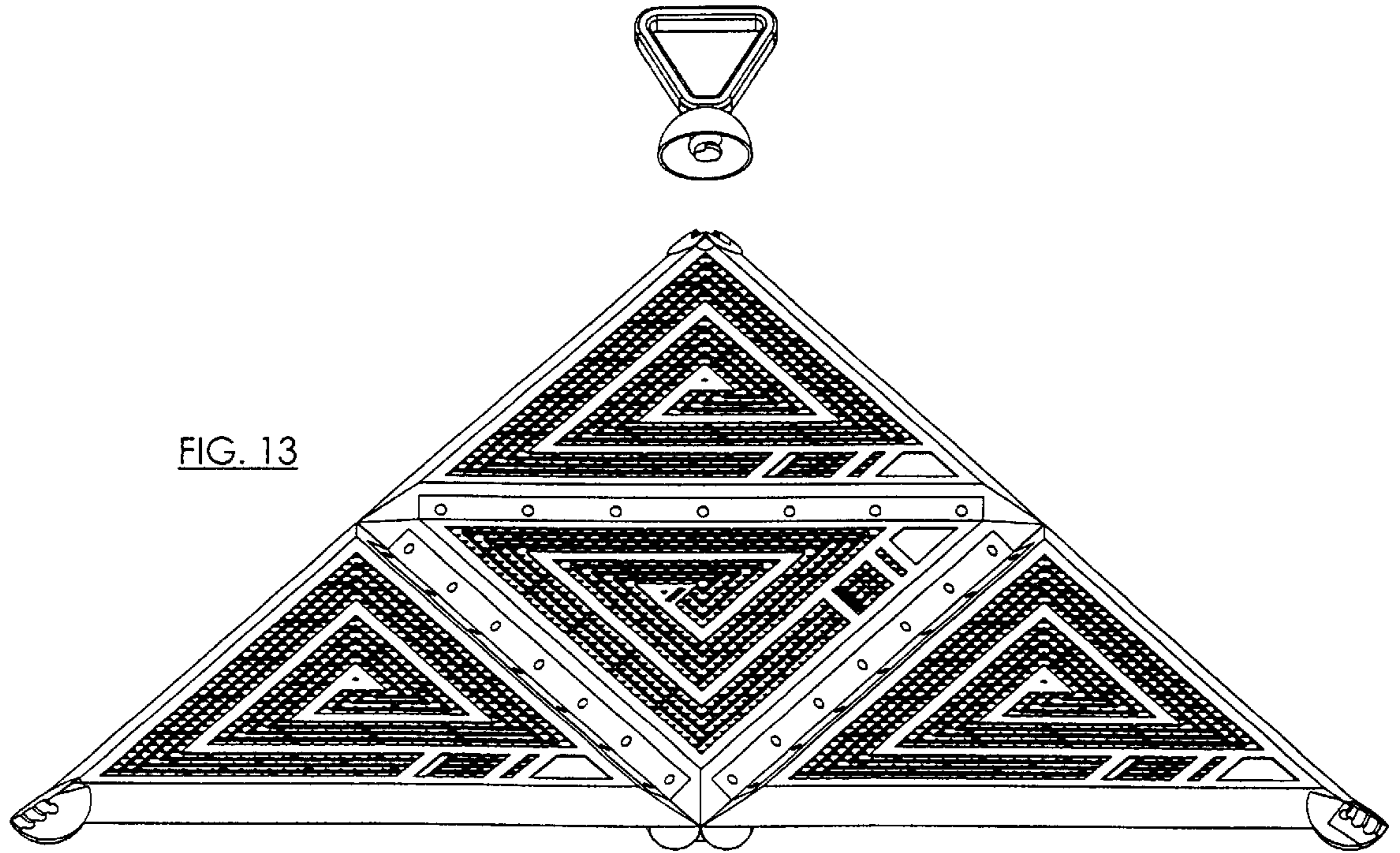

FIG. 13

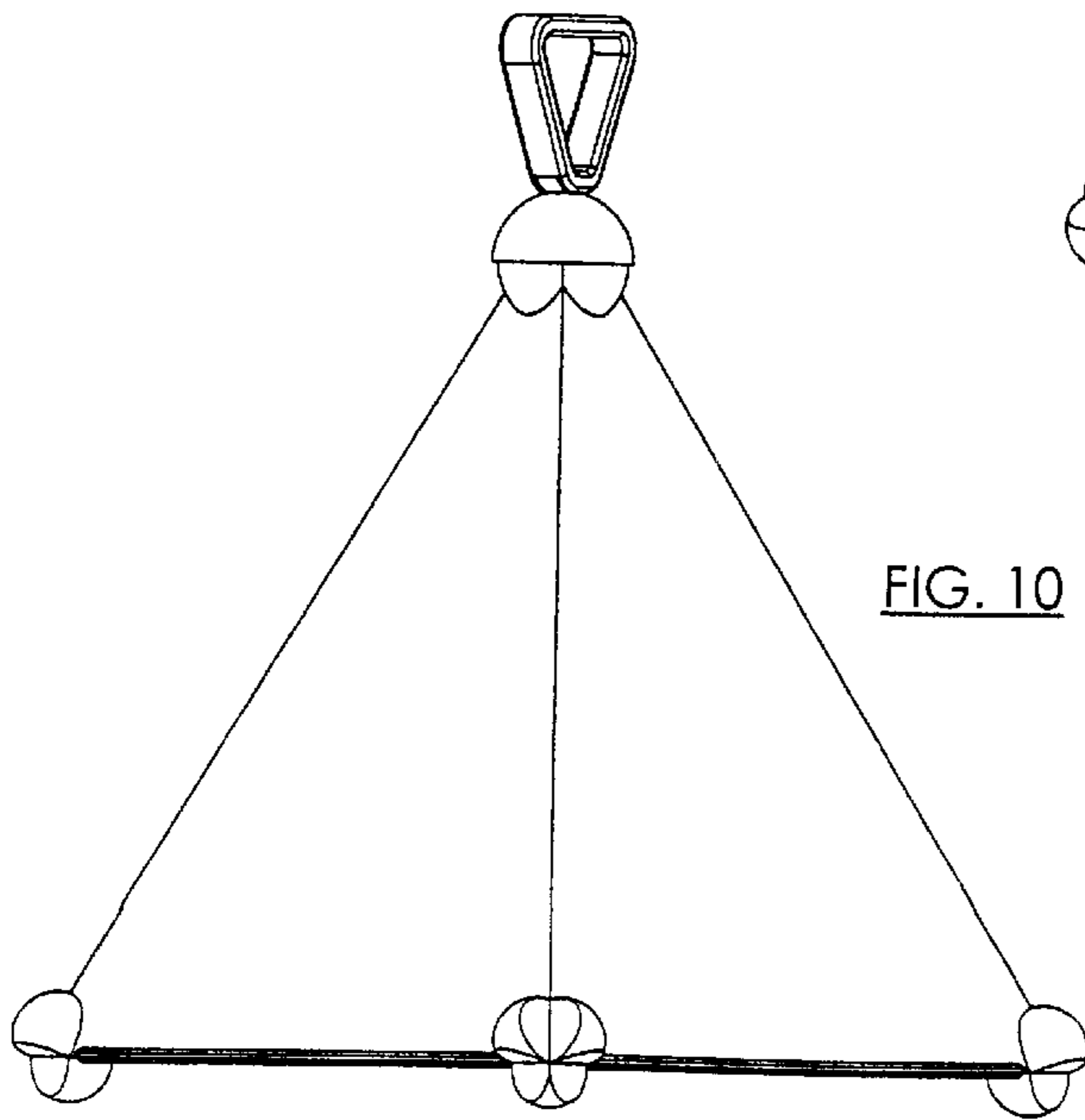

FIG. 10

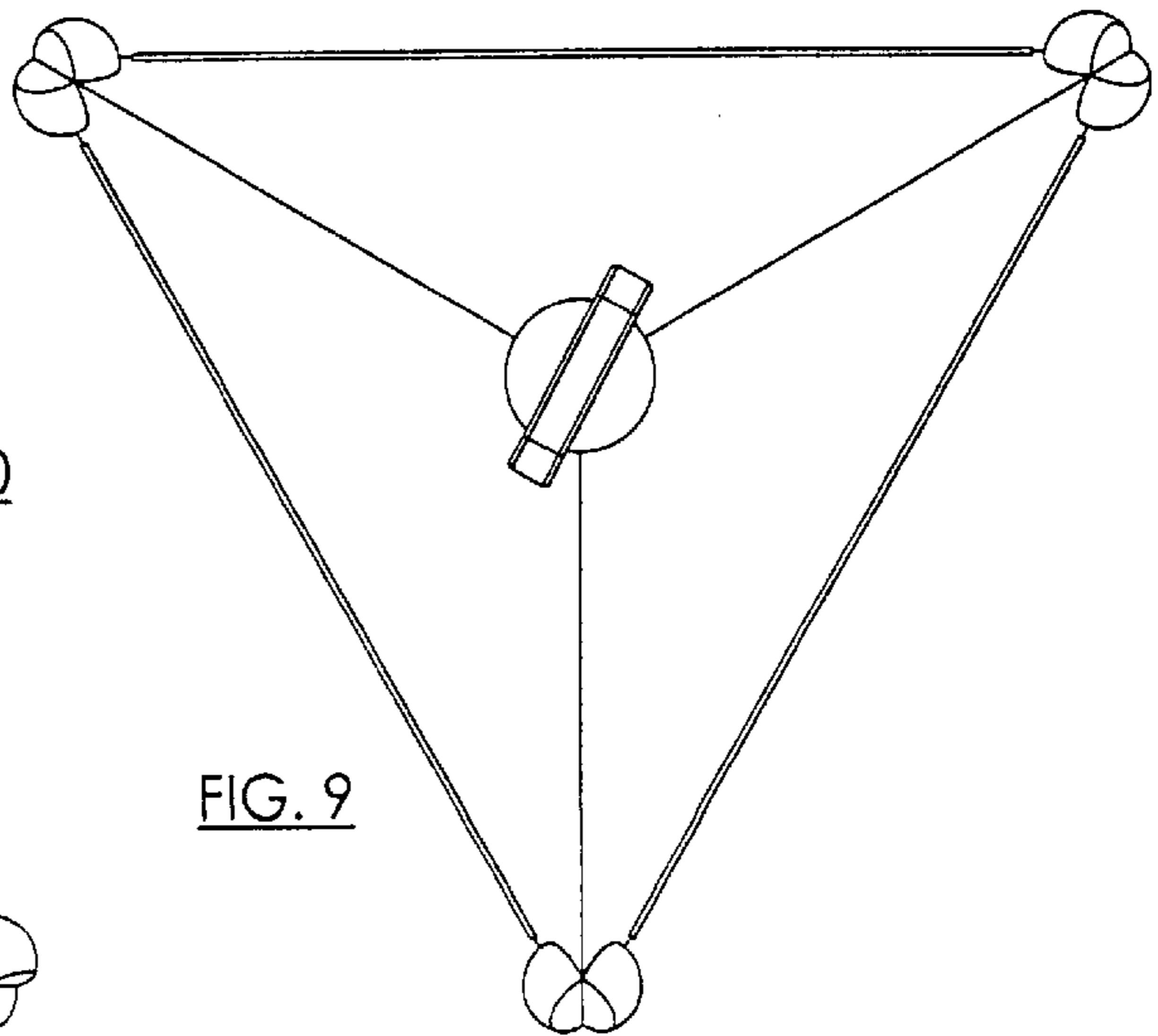

FIG. 9

