



US00D470433S

(12) **United States Design Patent**  
**Osawa**

(10) **Patent No.:** **US D470,433 S**

(45) **Date of Patent:** **\*\* Feb. 18, 2003**

(54) **SMALL FLOWER VASE**

(75) **Inventor:** **Shokichiro Osawa, Osaka (JP)**

(73) **Assignee:** **Izumi Chemical Co., Ltd., Osaka-fu (JP)**

(\*\*) **Term:** **14 Years**

(21) **Appl. No.:** **29/163,092**

(22) **Filed:** **Jun. 28, 2002**

(30) **Foreign Application Priority Data**

Dec. 28, 2001 (JP) ..... 2001-038730

(51) **LOC (7) Cl.** ..... **11-02**

(52) **U.S. Cl.** ..... **D11/146**

(58) **Field of Search** ..... D11/143, 144, D11/146, 152, 153, 154; D6/556; D26/72, 76; D99/5, 19; 47/41.01, 41.11, 41.12, 41.14, 41.15; 206/423; 248/27.8, 311.2

(56) **References Cited**

**U.S. PATENT DOCUMENTS**

809,172 A *	1/1906	Burdick	47/41.01
1,074,239 A *	9/1913	Braun	248/311.2
1,096,180 A *	5/1914	Meurling	47/41.11
1,868,023 A *	7/1932	North	47/41.01
D146,484 S *	3/1947	Moore	D6/556

D315,532 S *	3/1991	Belokin, Jr.	D11/146
D319,910 S *	9/1991	Hepburn et al.	D99/5
D365,041 S *	12/1995	Dollinger	D11/146
5,794,379 A *	8/1998	McKay	47/41.01
6,067,748 A *	5/2000	Williams	47/41.01
6,324,784 B1 *	12/2001	Bina	47/41.01

\* cited by examiner

*Primary Examiner*—Doris V. Coles

*Assistant Examiner*—Mimosa De

(74) *Attorney, Agent, or Firm*—Fitch, Even, Tabin & Flannery

(57) **CLAIM**

The ornamental design of a small flower vase, as shown.

**DESCRIPTION**

FIG. 1 is a front elevation view of a small flower vase showing my new design;  
 FIG. 2 is a rear elevation view thereof;  
 FIG. 3 is a side elevation view thereof;  
 FIG. 4 is a top plan view thereof;  
 FIG. 5 is a bottom plan view thereof;  
 FIG. 6 is a perspective view thereof;  
 FIG. 7 is a cross-sectional view taken in the direction of the arrows on line 7—7 of FIG. 4; and,  
 FIG. 8 is a cross-sectional view taken in the direction of the arrows on line 8—8 of FIG. 4.

**1 Claim, 8 Drawing Sheets**

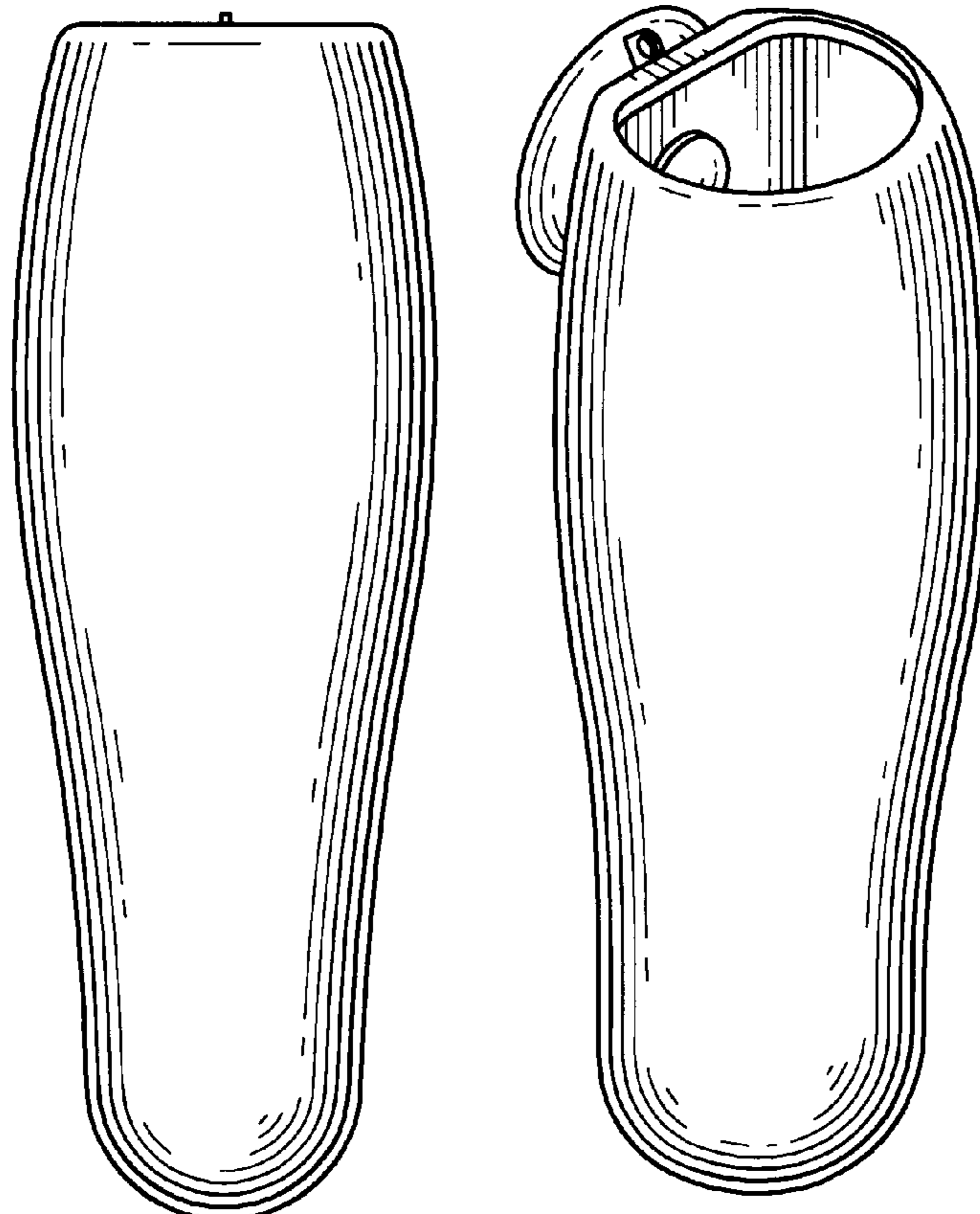

Fig. 1

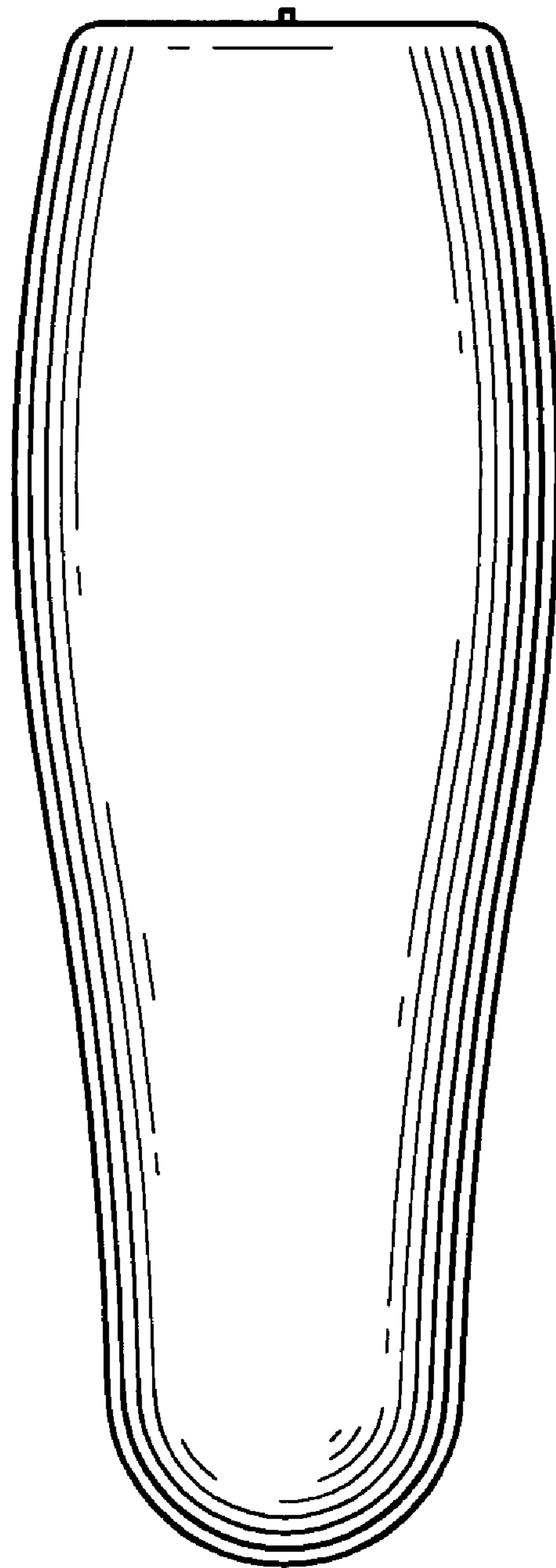

Fig. 2

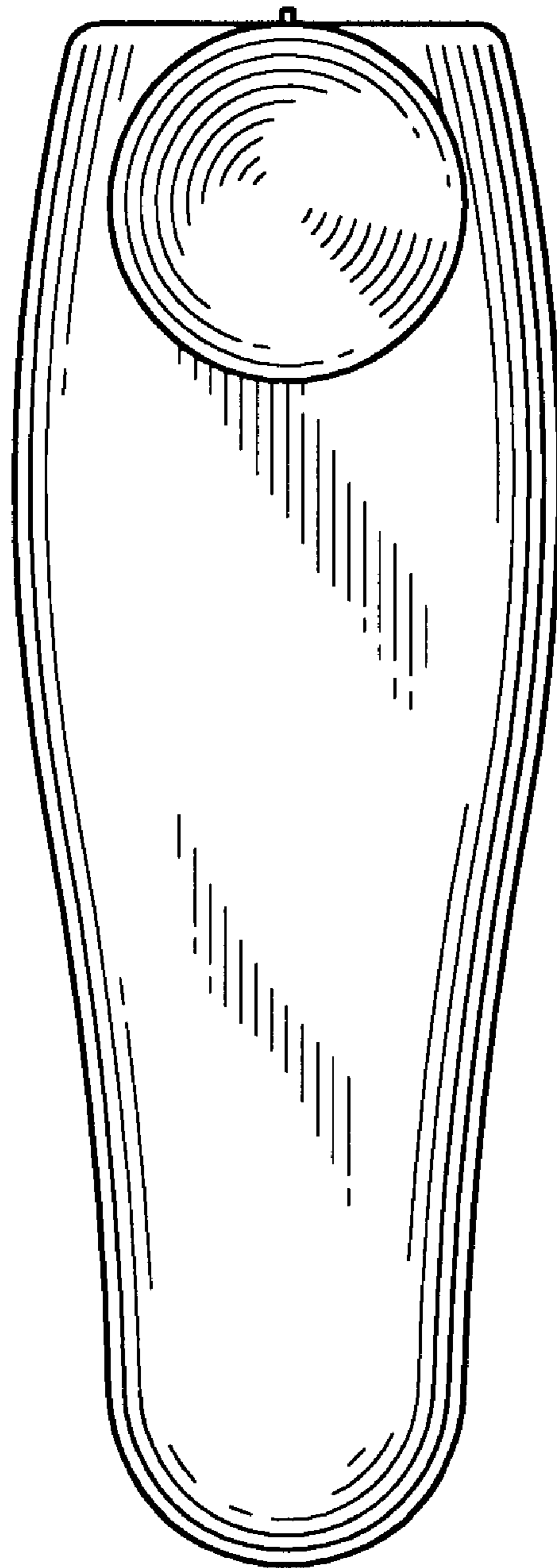
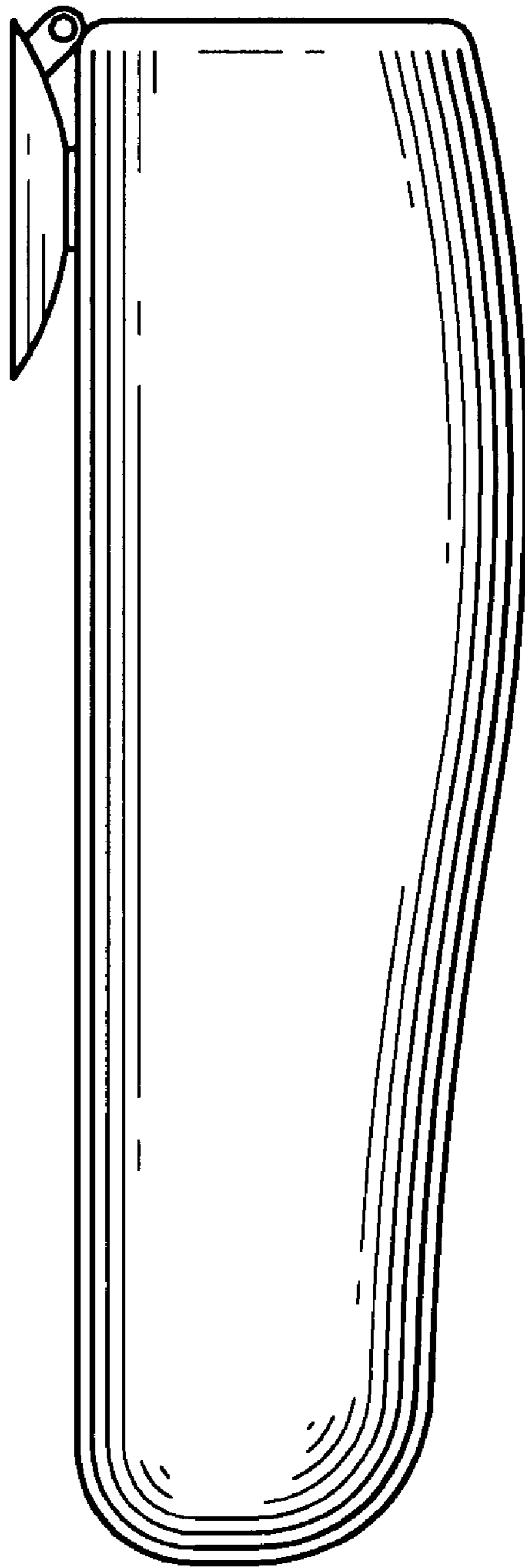
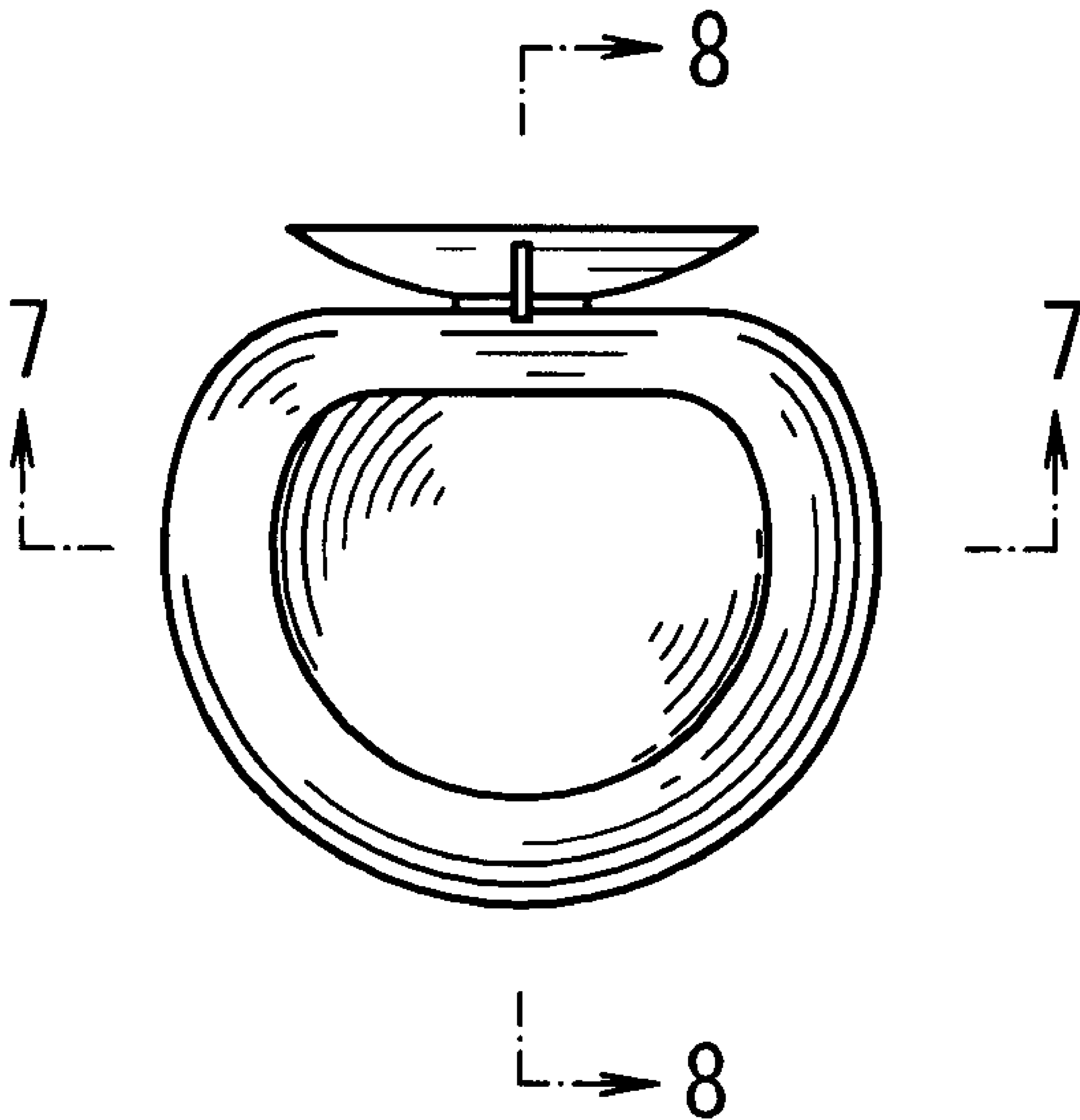

Fig. 3



# Fig. 4



# Fig. 5

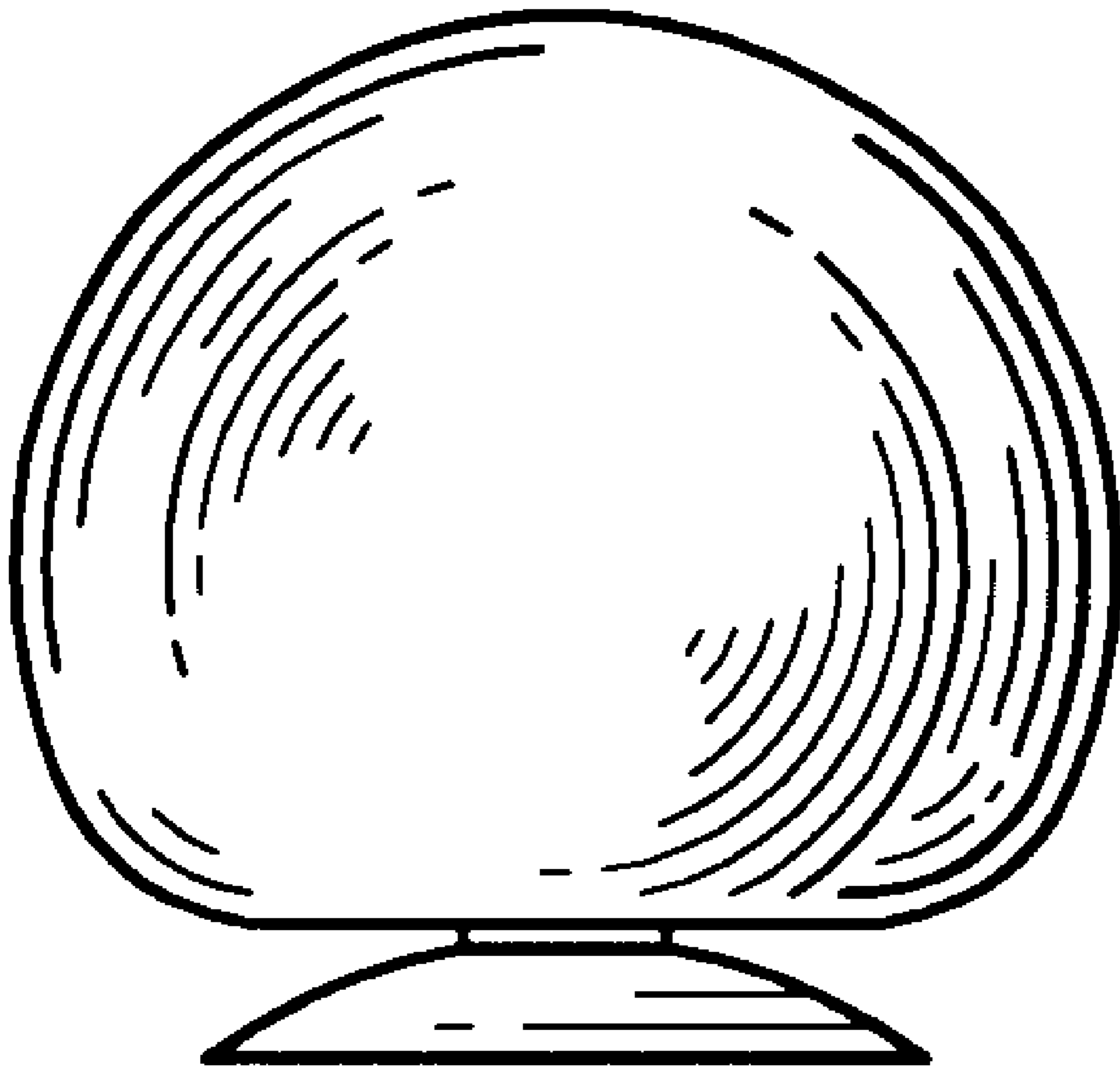

Fig. 6

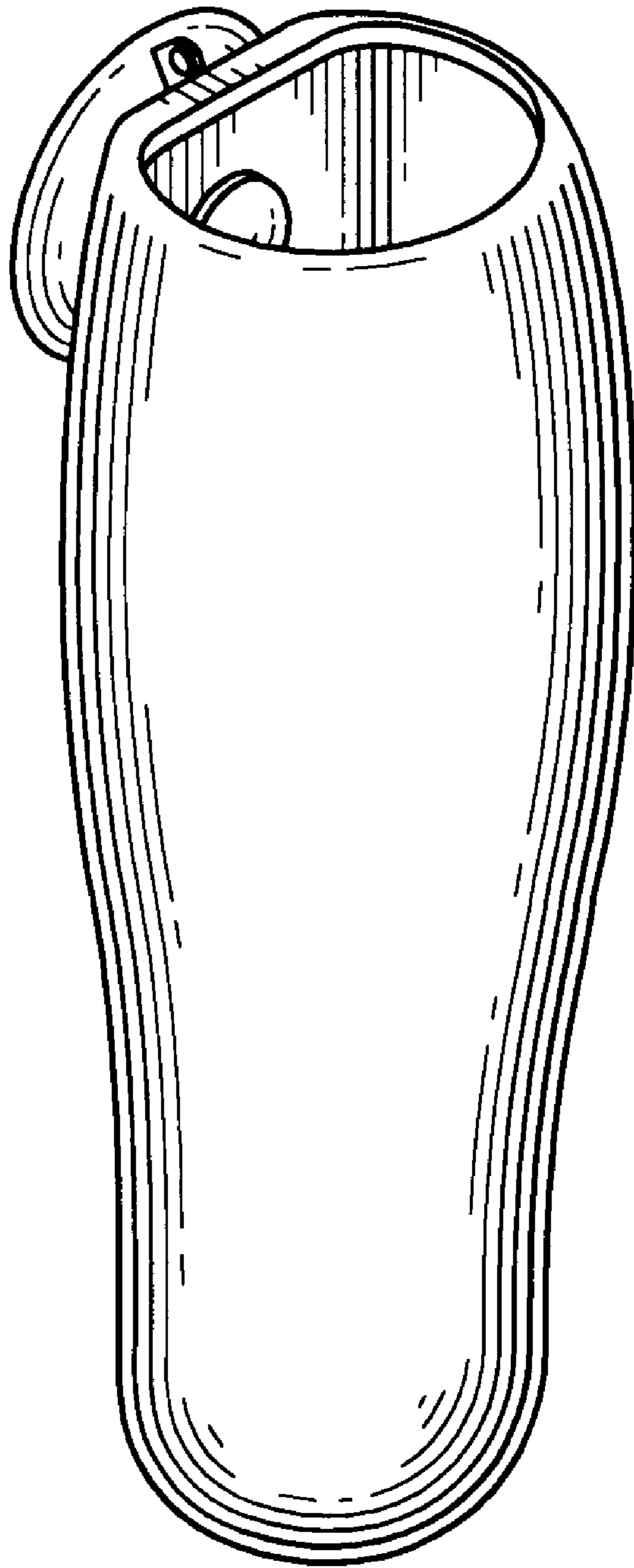

Fig. 7

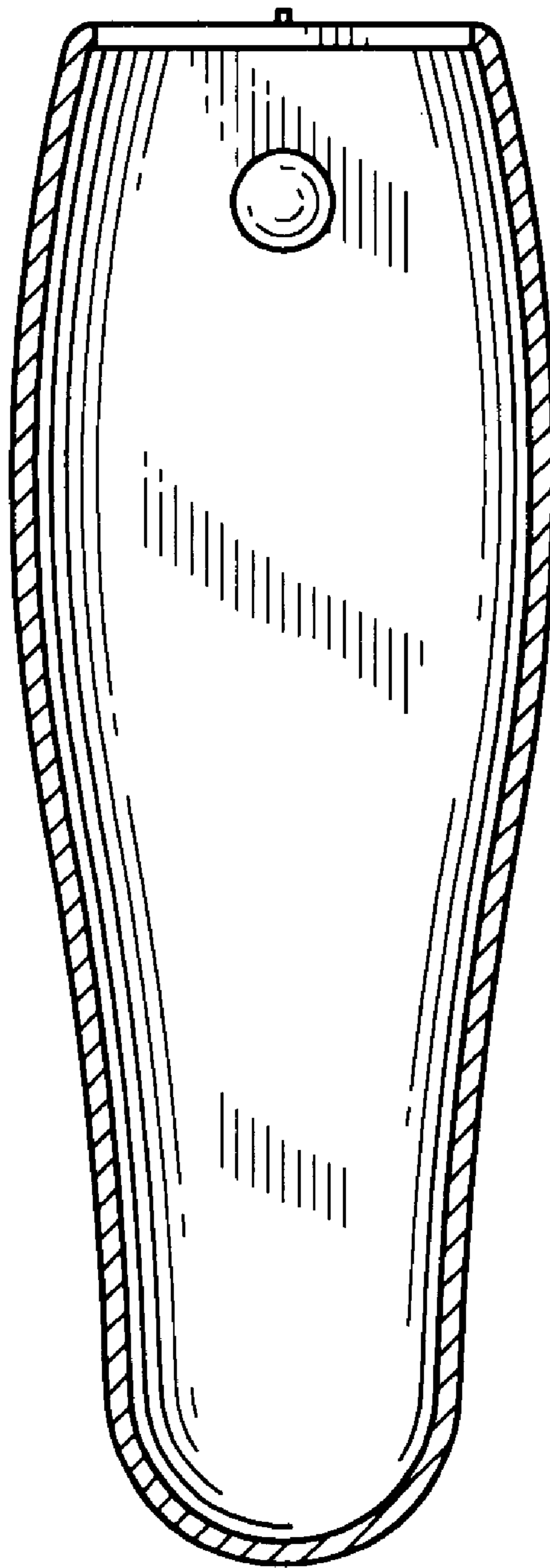



Fig. 8

