



US00D470347S

(12) **United States Design Patent**
Wood et al.

(10) **Patent No.:** **US D470,347 S**

(45) **Date of Patent:** **** Feb. 18, 2003**

(54) **CORNER FITTING**

(75) Inventors: **Graham R. Wood**, Glencoe, IL (US);
Brett Woodley, Wilmette, IL (US)

(73) Assignee: **Opto International, Inc.**, Wheeling, IL (US)

(**) Term: **14 Years**

(21) Appl. No.: **29/153,984**

(22) Filed: **Jan. 15, 2002**

(51) **LOC (7) Cl.** **06-06**

(52) **U.S. Cl.** **D6/491**

(58) **Field of Search** D6/480-489, 511,
D6/491; 108/153.1, 155, 156, 157.1, 161,
65, 27; 312/140.1, 140.2, 140.3; 248/345.1;
D8/403

(56) **References Cited**

U.S. PATENT DOCUMENTS

1,542,138 A * 6/1925 Hunter 108/27

D275,251 S * 8/1984 Buchanan D8/403 X
D301,953 S * 7/1989 Evenson D6/491
6,431,092 B1 * 8/2002 Stanford 108/132

* cited by examiner

Primary Examiner—Janice E. Seeger

(74) *Attorney, Agent, or Firm*—Welsh & Katz, Ltd.

(57) **CLAIM**

The ornamental design for a corner fitting, as shown and described.

DESCRIPTION

FIG. 1 is a front view of the corner fitting.
FIG. 2. is a left side view of the corner fitting of FIG. 1.
FIG. 3. is a right side view of the corner fitting of FIG. 1.
FIG. 4. is a rear view of the corner fitting of FIG. 1.
FIG. 5. is a bottom view of the corner fitting of FIG. 1.
FIG. 6. is a top view of the corner fitting of FIG. 1; and,
FIG. 7. is a perspective view of the corner fitting of FIG. 1.
The broken lines are for environmental purposes only and form no part of the claimed design.

1 Claim, 3 Drawing Sheets

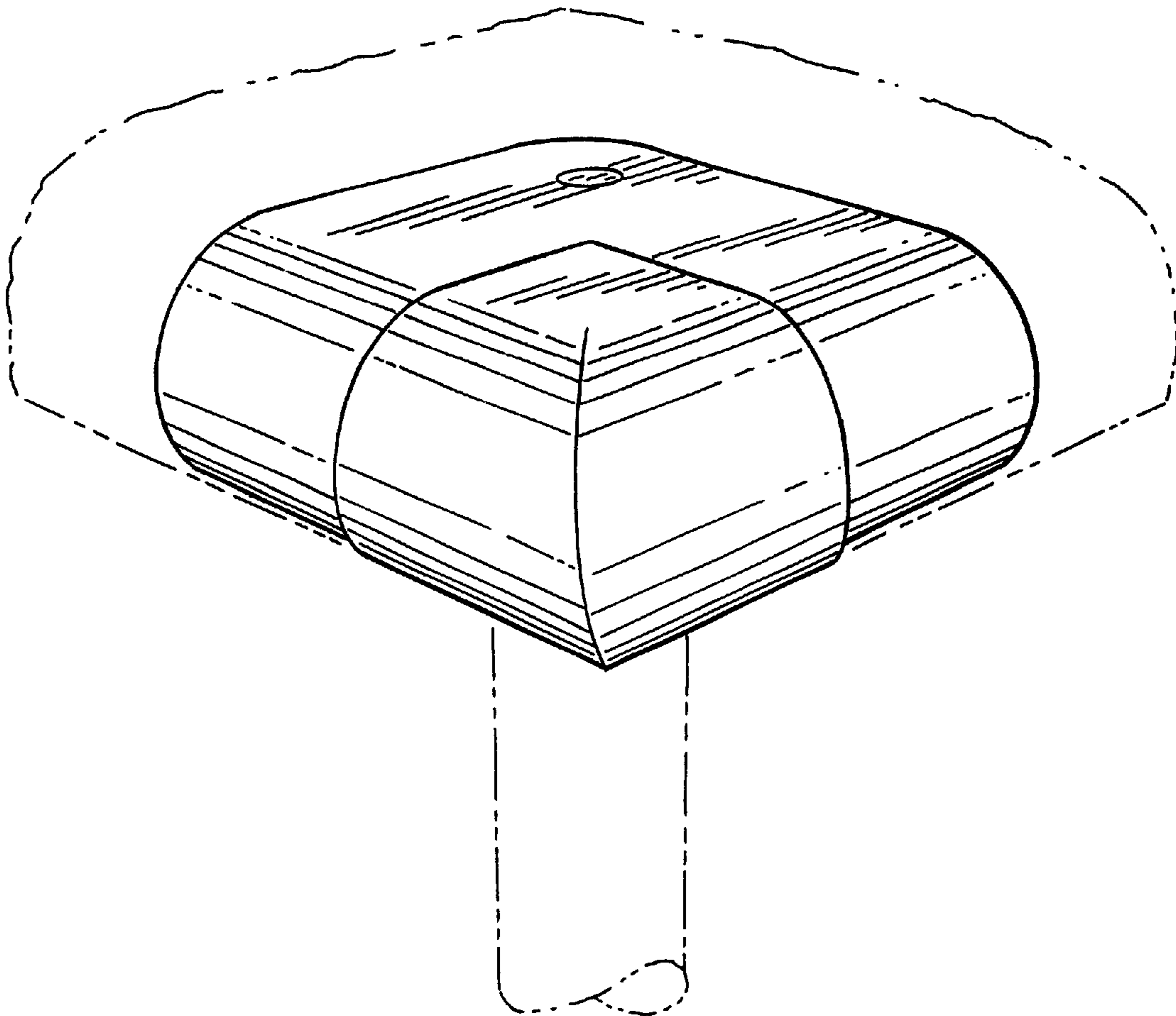

FIG. 1

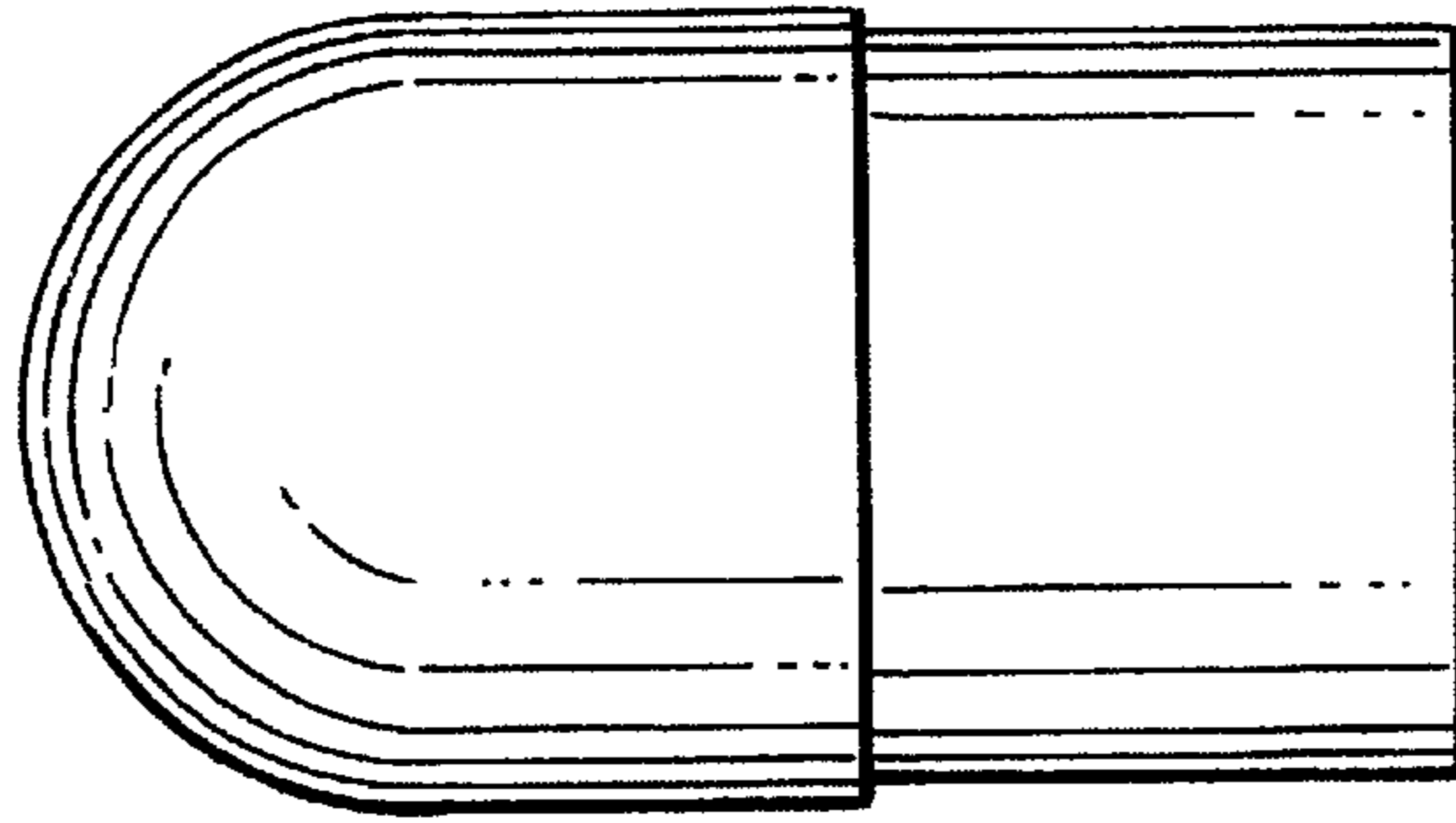

FIG. 2

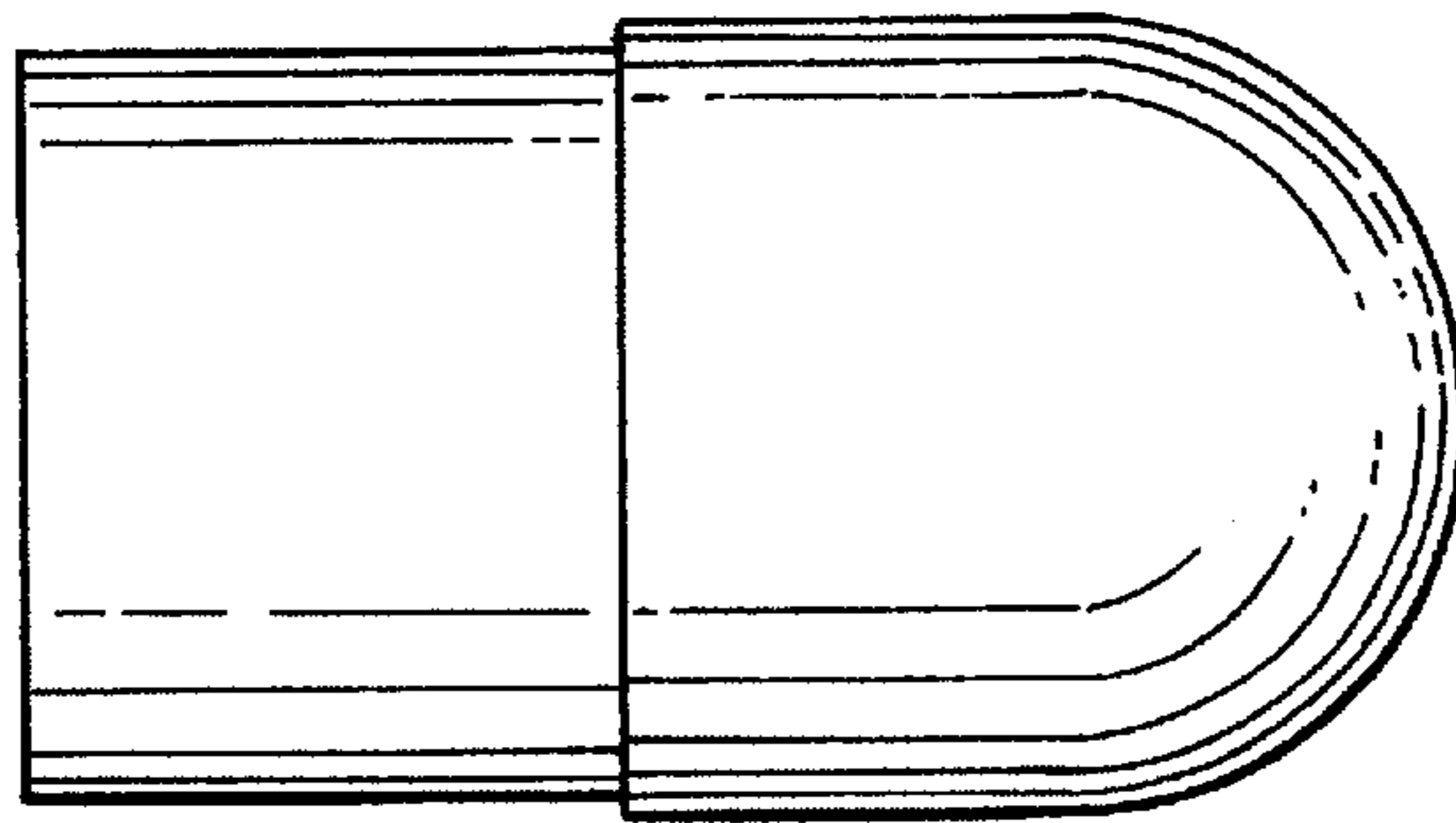

FIG. 3

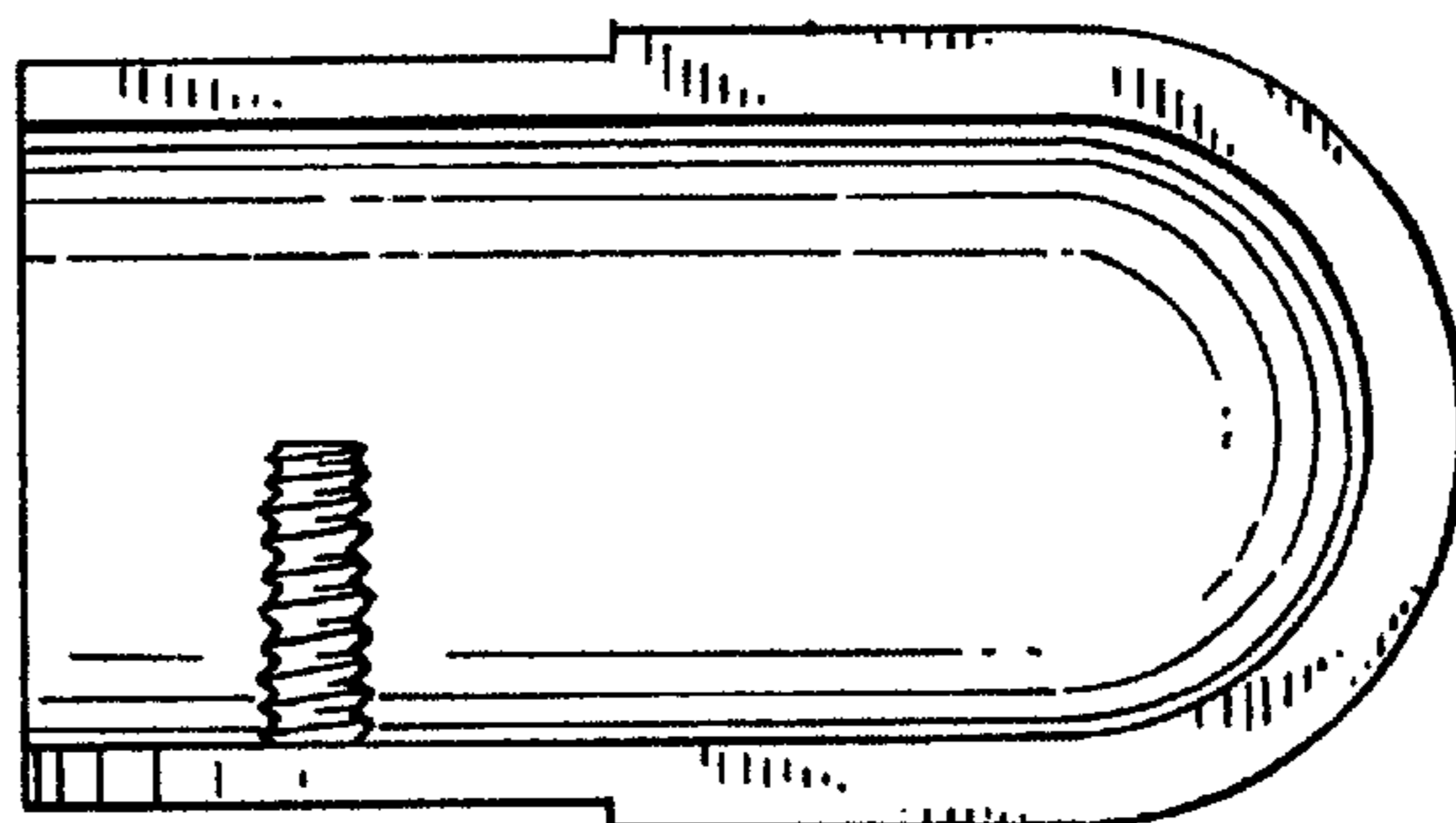

FIG.4

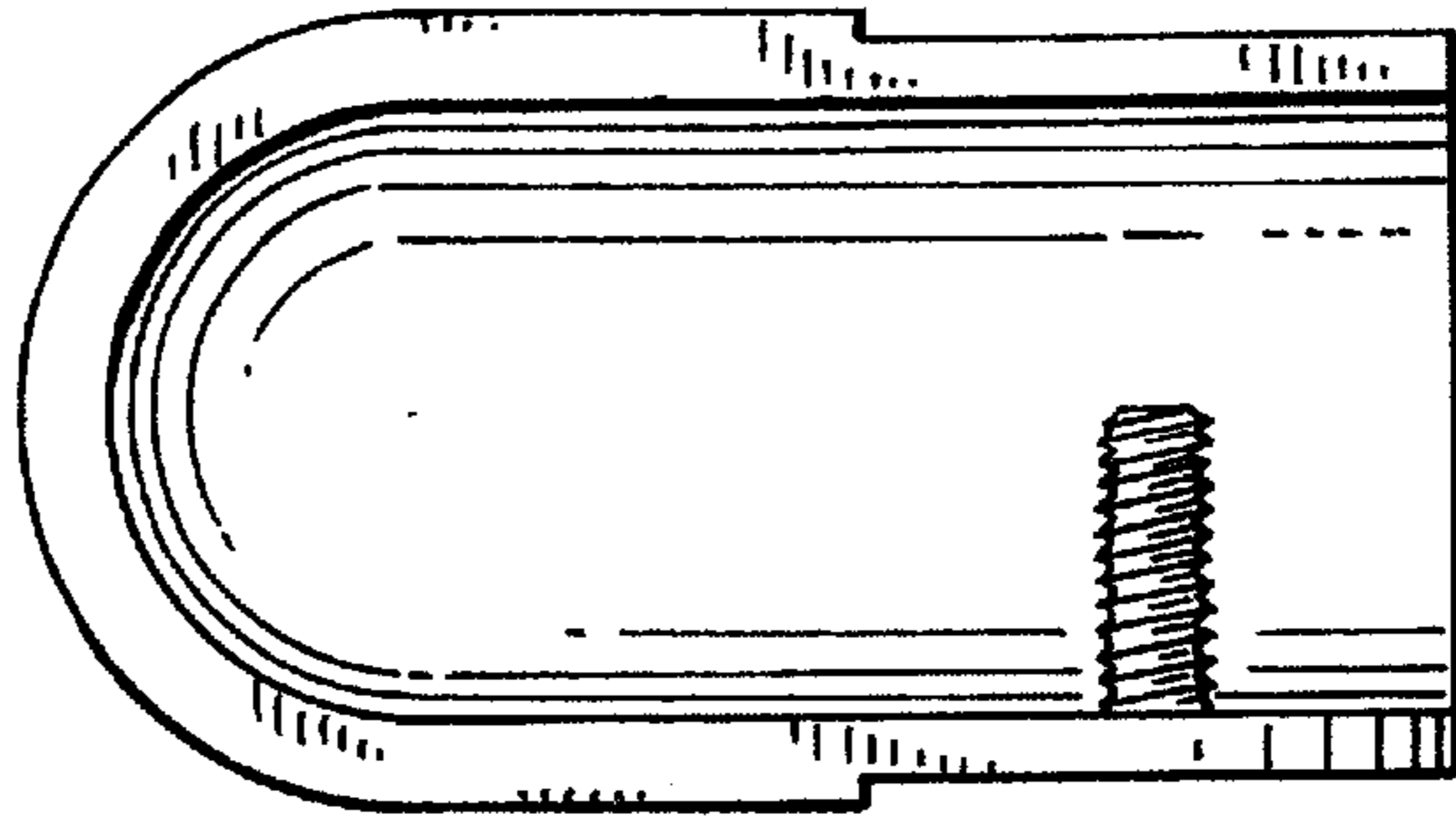

FIG.5

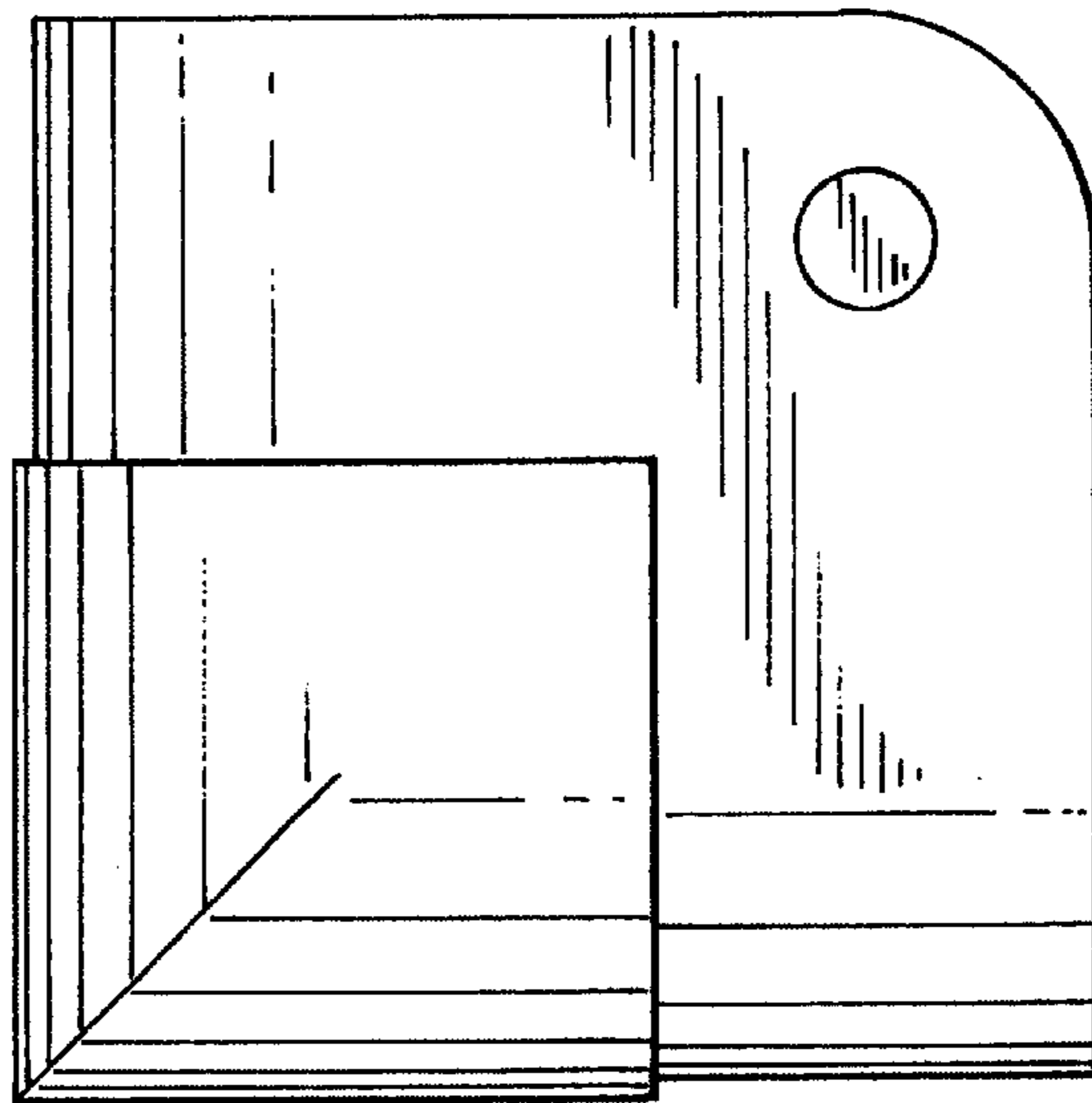

FIG.6

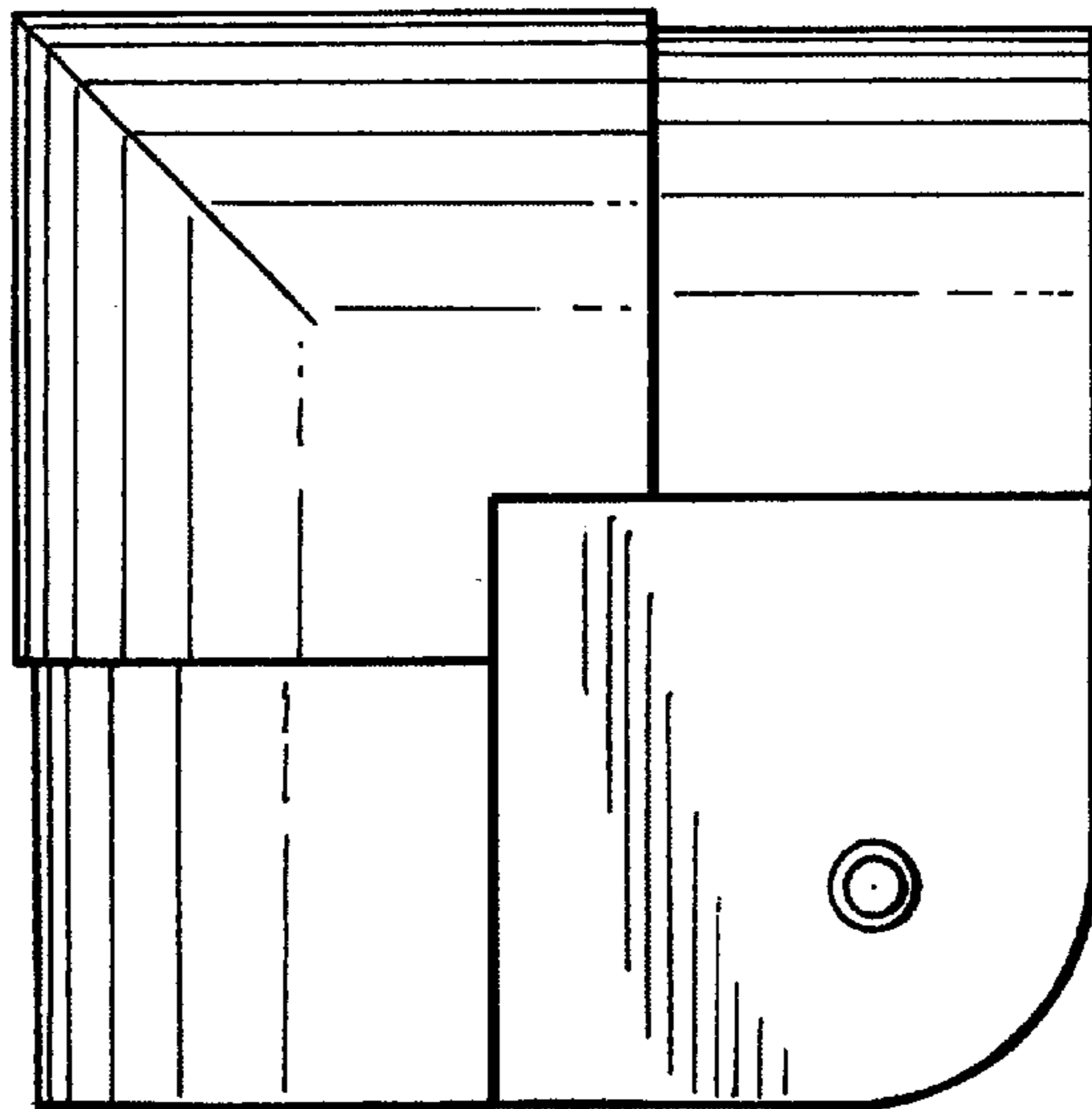

FIG. 7

