



US00D470315S

(12) **United States Design Patent**
Tapley et al.

(10) **Patent No.: US D470,315 S**

(45) **Date of Patent: ** Feb. 18, 2003**

(54) **PAINT BRUSH HANDLE**

(76) Inventors: **Chris Tapley**, 223 Avondale Street,
Hamilton, Ontario (CA), L8L 7C4; **Ed**
Vaes, 223 Avondale Street, Hamilton,
Ontario (CA), L8L 7C4

(**) Term: **14 Years**

(21) Appl. No.: **29/137,731**

(22) Filed: **Feb. 28, 2001**

Related U.S. Application Data

(62) Division of application No. 29/103,624, filed on Apr. 19,
1999, now Pat. No. Des. 448,178.

(30) **Foreign Application Priority Data**

Oct. 22, 1998 (CA) 1998-2600

(51) **LOC (7) Cl.** **04-04**

(52) **U.S. Cl.** **D4/138**

(58) **Field of Search** D4/132, 135, 138;
D7/393, 395; D8/107; 15/143.1, 159.1,
160, 168, 191.1, 192, 193, 194, 145; 16/110.1,
430

(56) **References Cited**

U.S. PATENT DOCUMENTS

2,258,361 A * 10/1941 Hewes 15/192

3,971,094 A * 7/1976 Solf et al. 15/143.1
4,134,171 A * 1/1979 Love 15/145 X
4,469,223 A * 9/1984 Smith 15/143.1 X
4,494,268 A * 1/1985 Chu 15/194 X
4,598,437 A * 7/1986 Ernest et al. 15/145 X
D412,618 S * 8/1999 Parker et al. D4/132

FOREIGN PATENT DOCUMENTS

JP 1-213142 * 8/1989 B65D/5/44

* cited by examiner

Primary Examiner—Alan P. Douglas

Assistant Examiner—Lavone D. Tabor

(57) **CLAIM**

The ornamental design for a paint brush handle, as shown.

DESCRIPTION

FIG. 1 is a top plan view of a paint brush handle showing our
new design;

FIG. 2 is a side elevational view of FIG. 1;

FIG. 3 is an top perspective view of FIG. 1;

FIG. 4 is an bottom perspective view of FIG. 1;

FIG. 5 is a side elevational view of the second embodiment
of the paint brush handle;

FIG. 6 is an top perspective view of the embodiment shown
in FIG. 5; and,

FIG. 7 is an bottom perspective view of the embodiment
shown in FIG. 5.

1 Claim, 6 Drawing Sheets

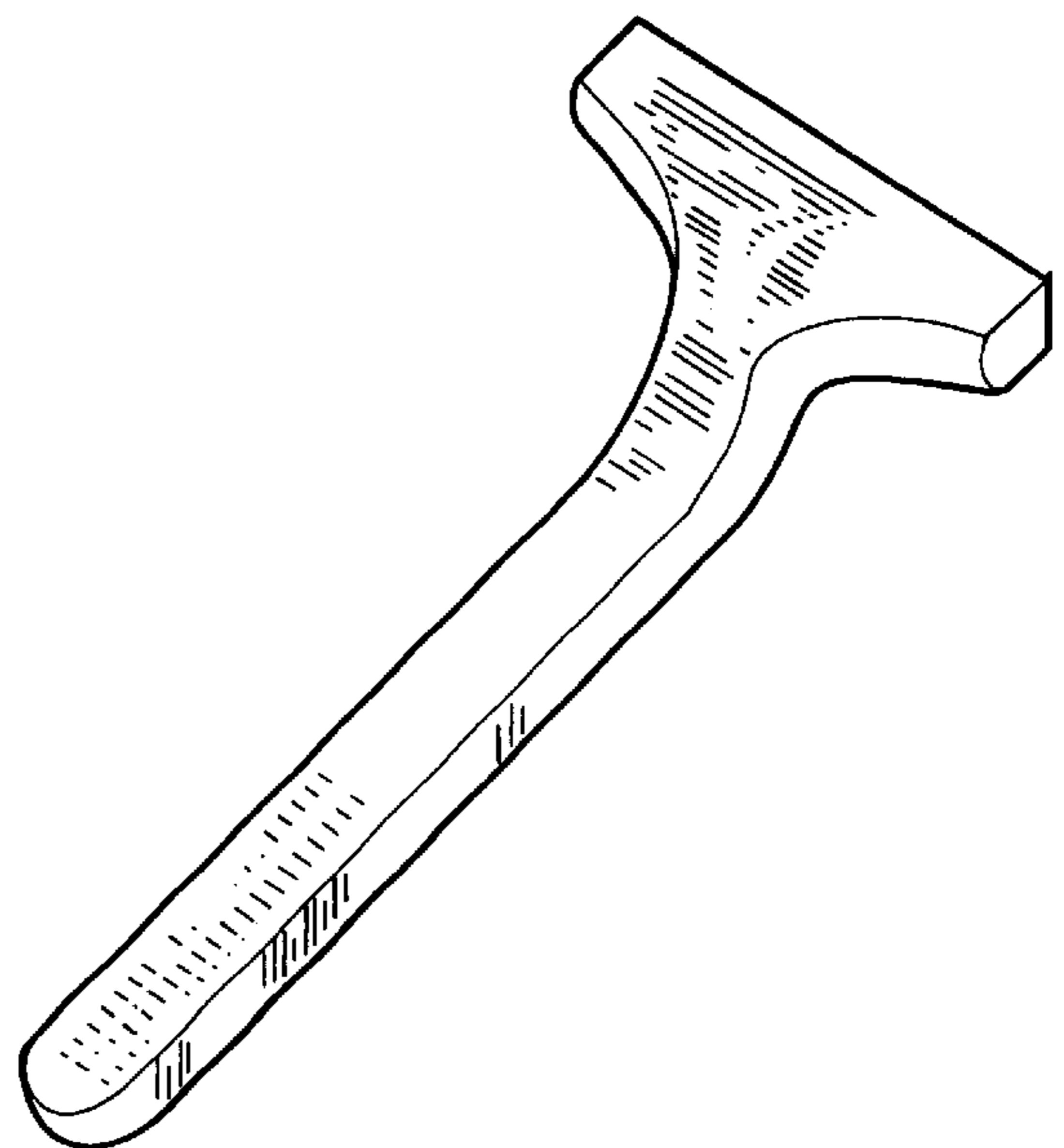
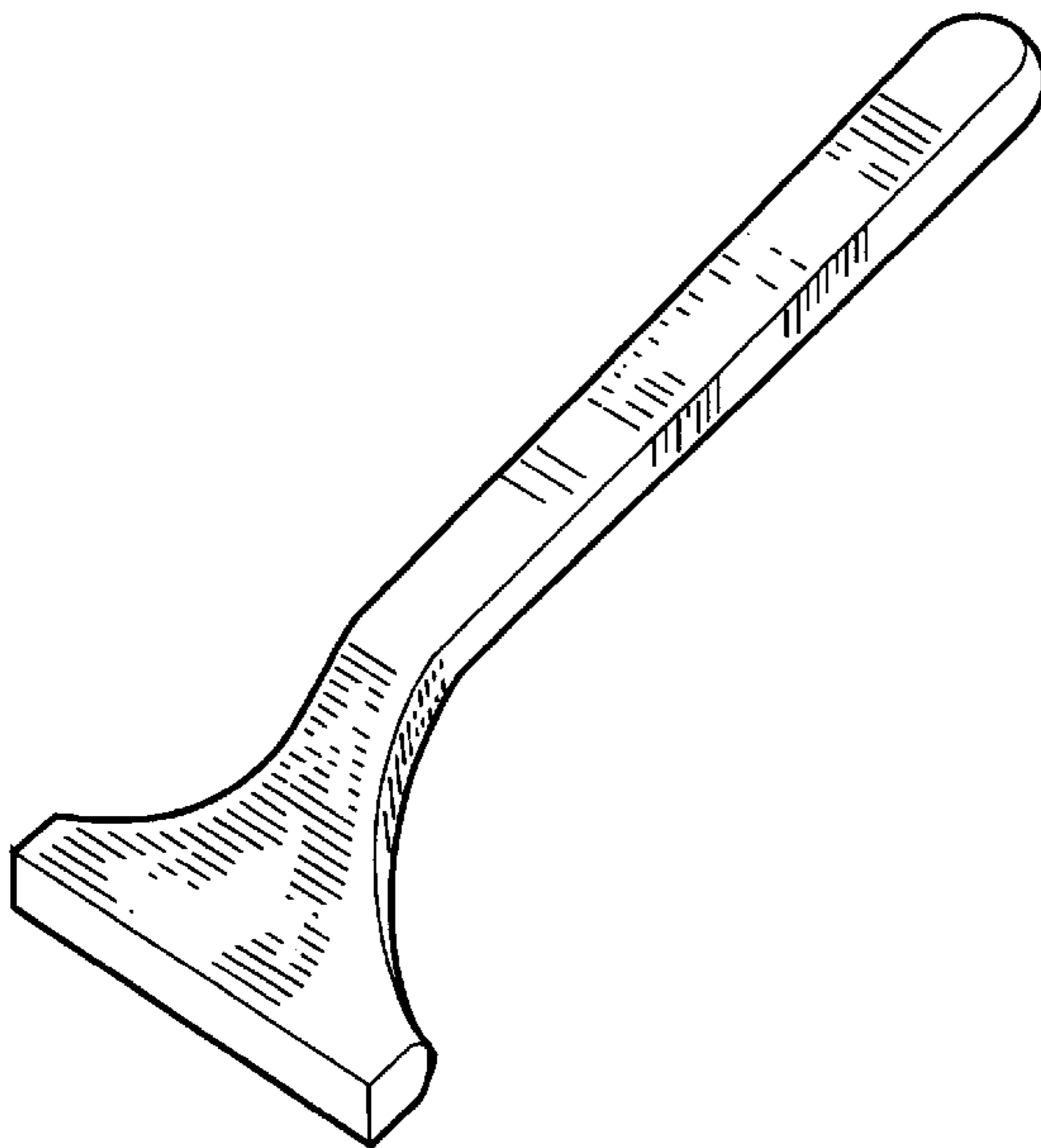

FIG-1

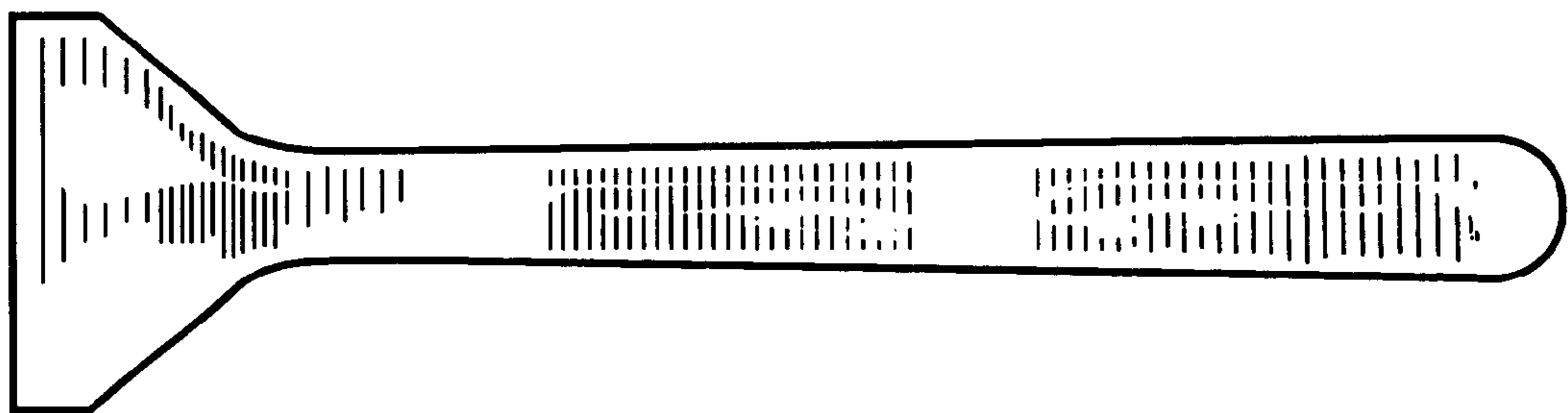

FIG-2

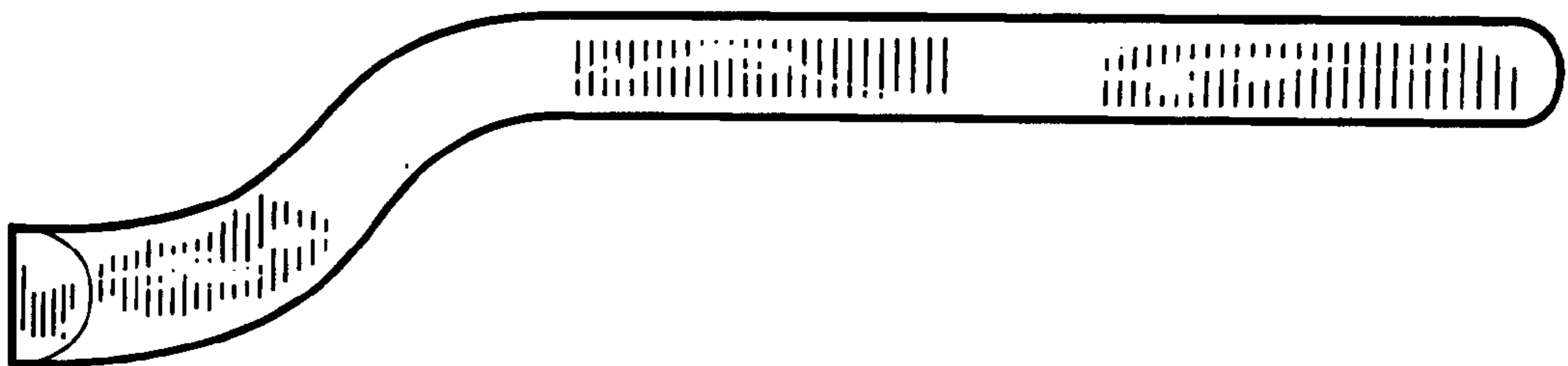

FIG-3

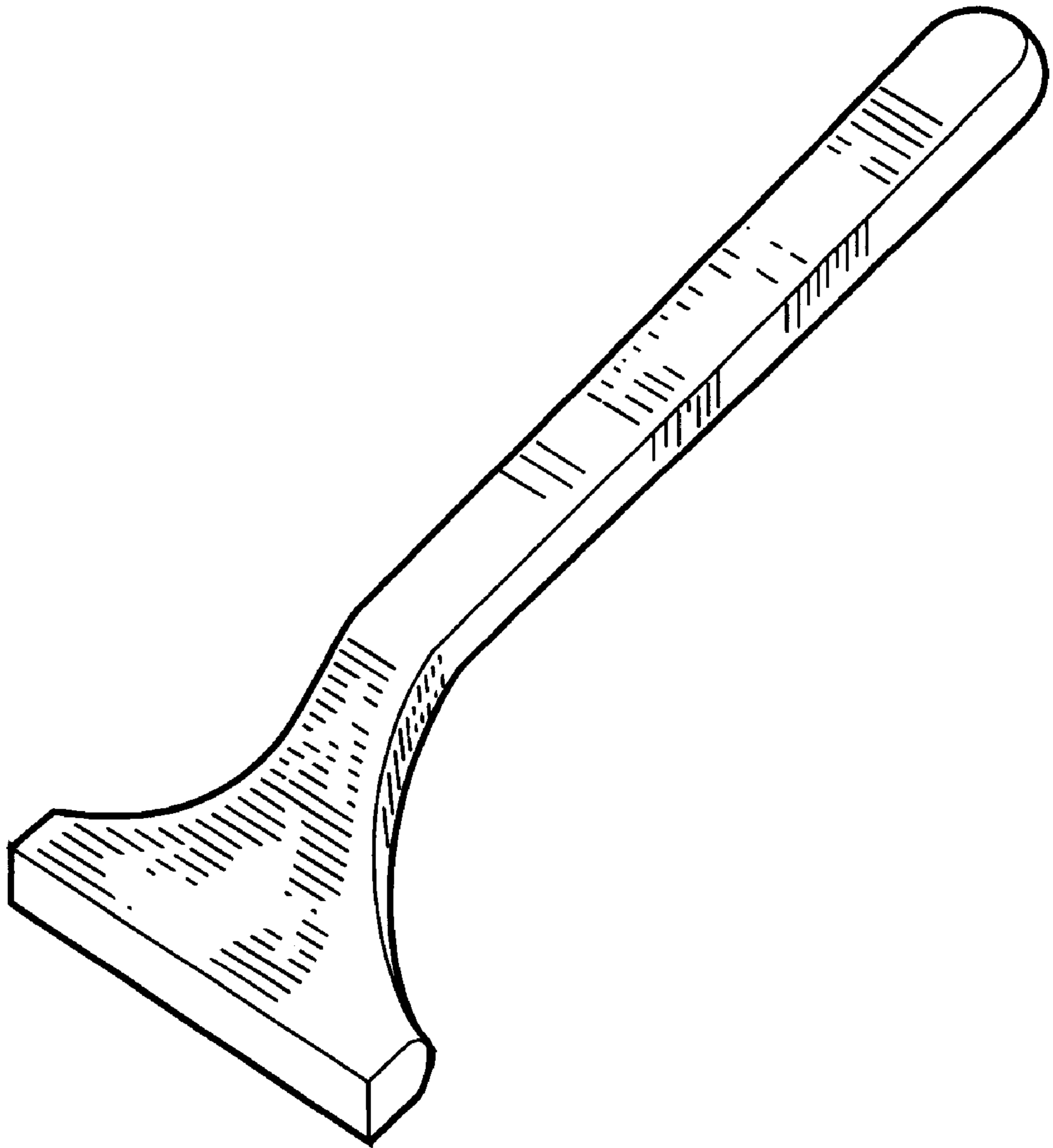

FIG-4

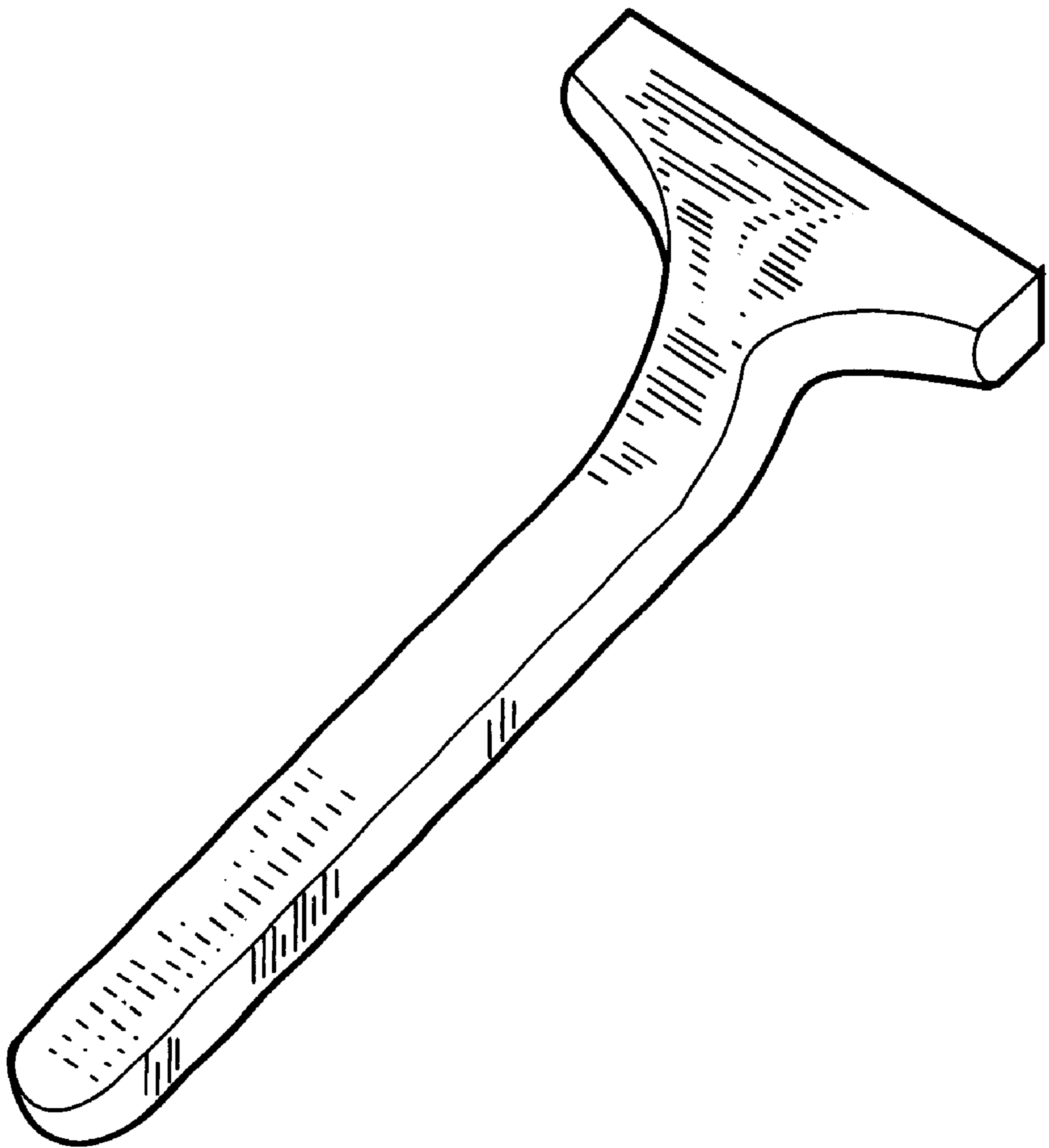

FIG-5

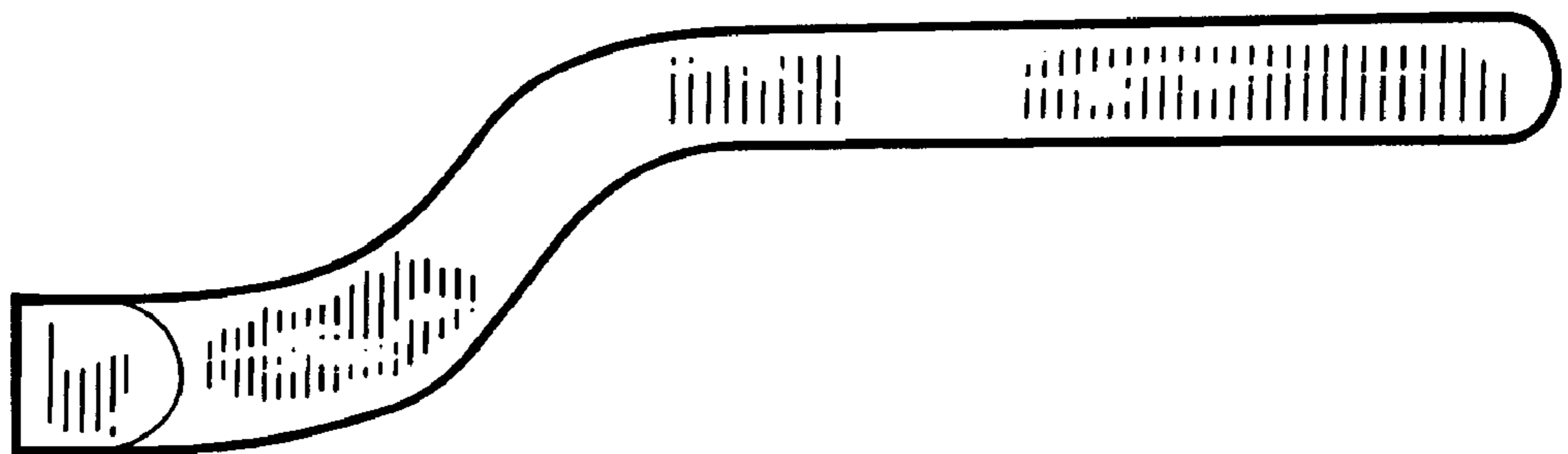

FIG-6

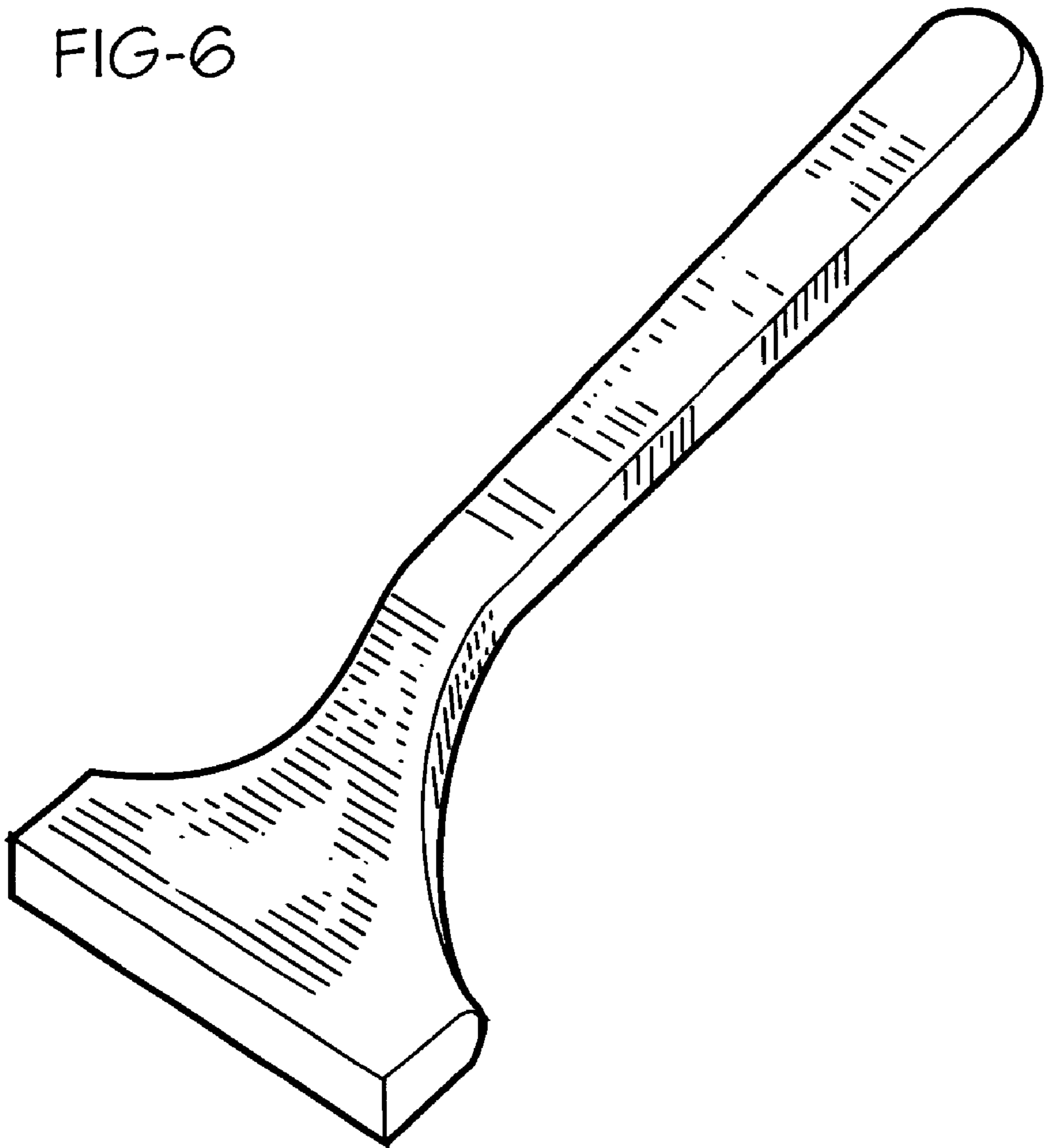

FIG-7

