



US00D470220S

(12) **United States Design Patent**
Nien

(10) **Patent No.:** **US D470,220 S**

(45) **Date of Patent:** **** Feb. 11, 2003**

(54) **WATER PISTOL**

D453,814 S * 2/2002 Wang D23/226

(76) Inventor: **Mei-Yu Nien**, No. 2, Yung Feng Lane,
Hsin Pao Village, Fang Yuan Hsiang
Chang Hua Hsien (TW)

* cited by examiner

Primary Examiner—Robin V. Taylor
(74) *Attorney, Agent, or Firm*—Harrison & Egbert

(**) Term: **14 Years**

(57) **CLAIM**

(21) Appl. No.: **29/161,526**

I claim the ornamental design for a water pistol, as shown and described.

(22) Filed: **Jun. 30, 2002**

DESCRIPTION

(51) **LOC (7) Cl.** **23-01**

(52) **U.S. Cl.** **D23/226**

(58) **Field of Search** D23/213, 223,
D23/226; 239/525–528

FIG. 1 is an upper perspective view of the water pistol showing my design.

FIG. 2 is a front view thereof;

FIG. 3 is a back view thereof;

FIG. 4 is a side view thereof;

FIG. 5 is an opposite side view thereof;

FIG. 6 is a top view thereof; and,

FIG. 7 is a bottom view thereof.

(56) **References Cited**

U.S. PATENT DOCUMENTS

- D431,070 S * 9/2000 Hsieh D23/226
- D446,283 S * 8/2001 Wang D23/226
- D452,297 S * 12/2001 Chao D23/226

1 Claim, 4 Drawing Sheets

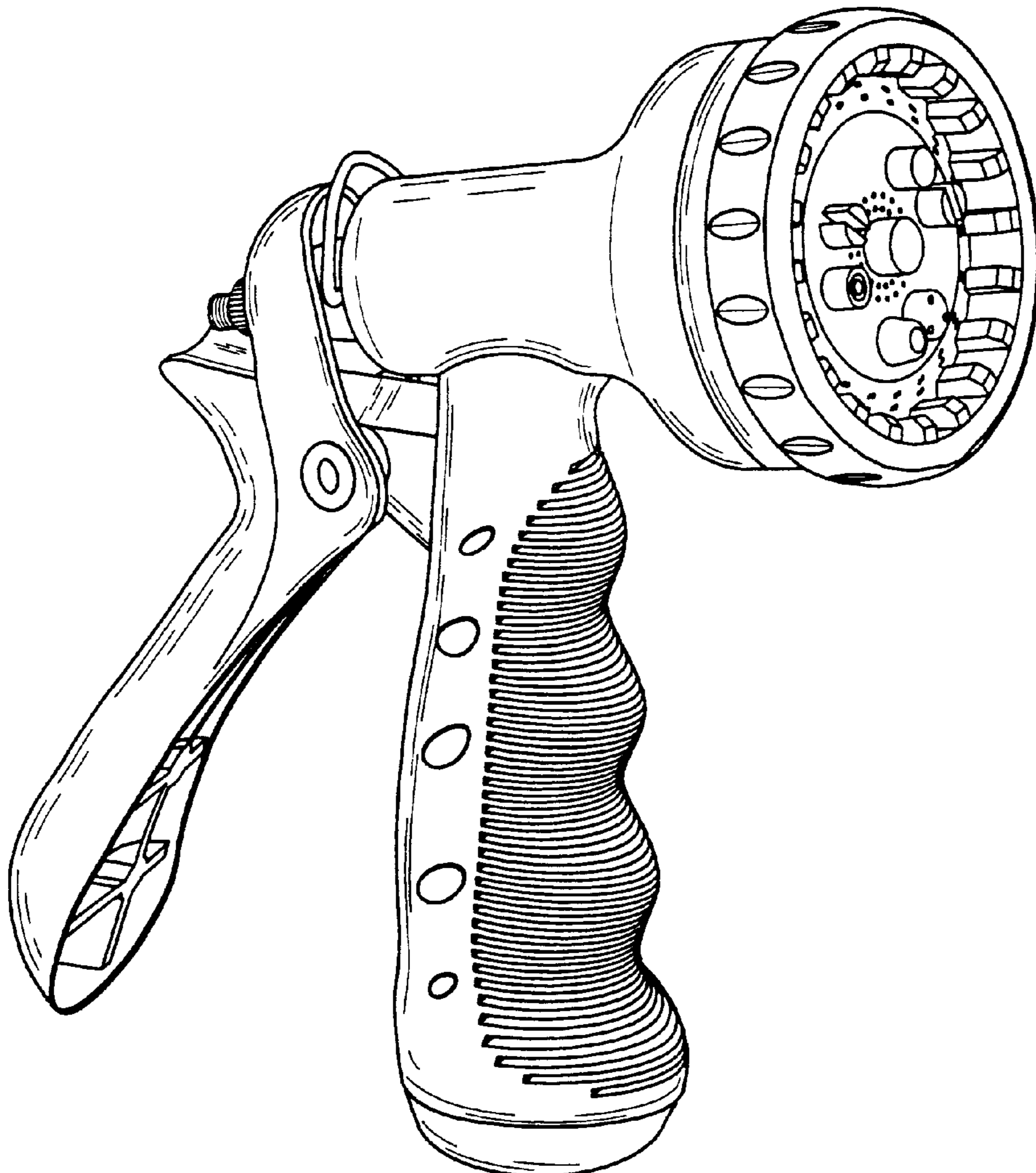

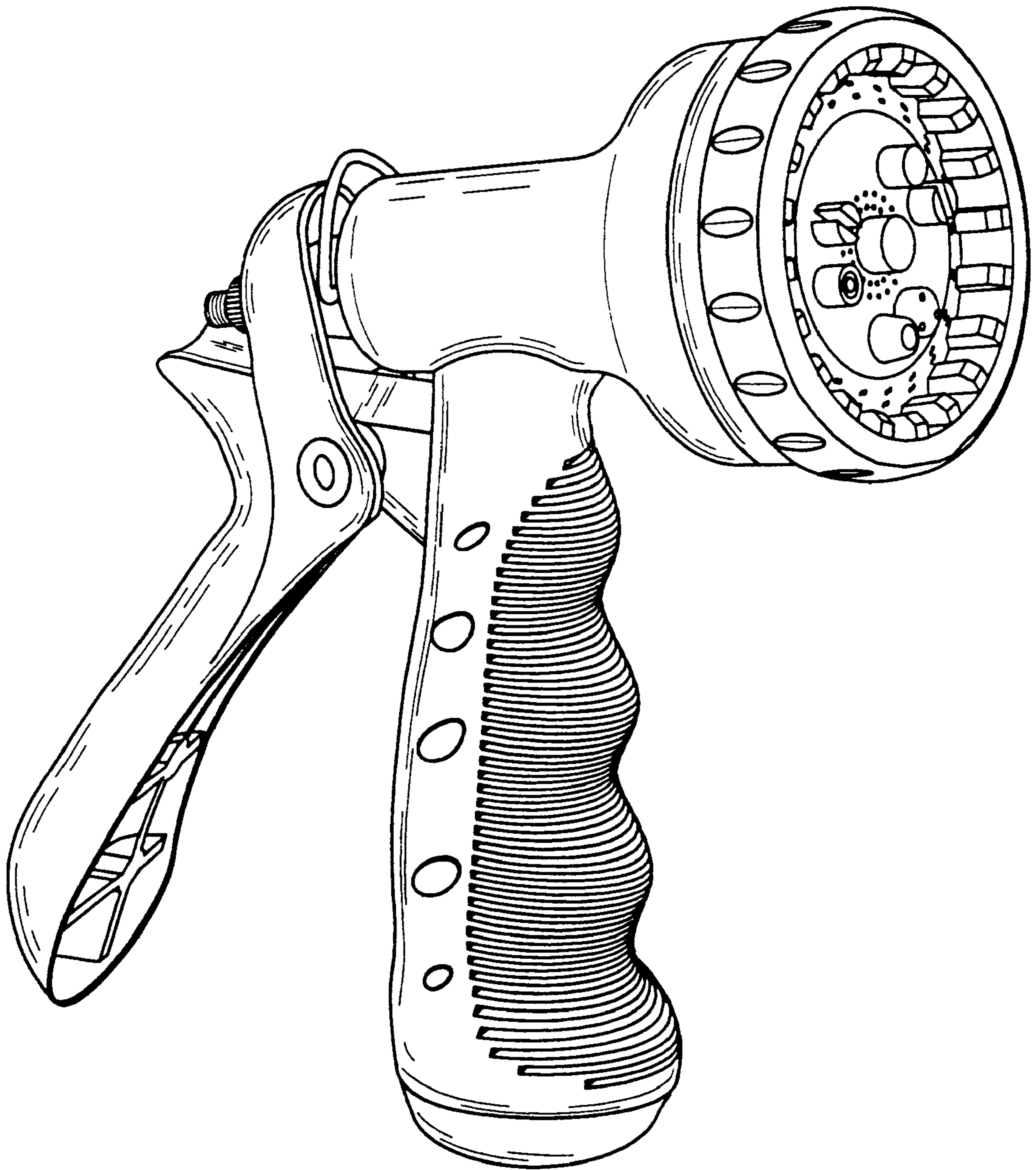

FIG.1

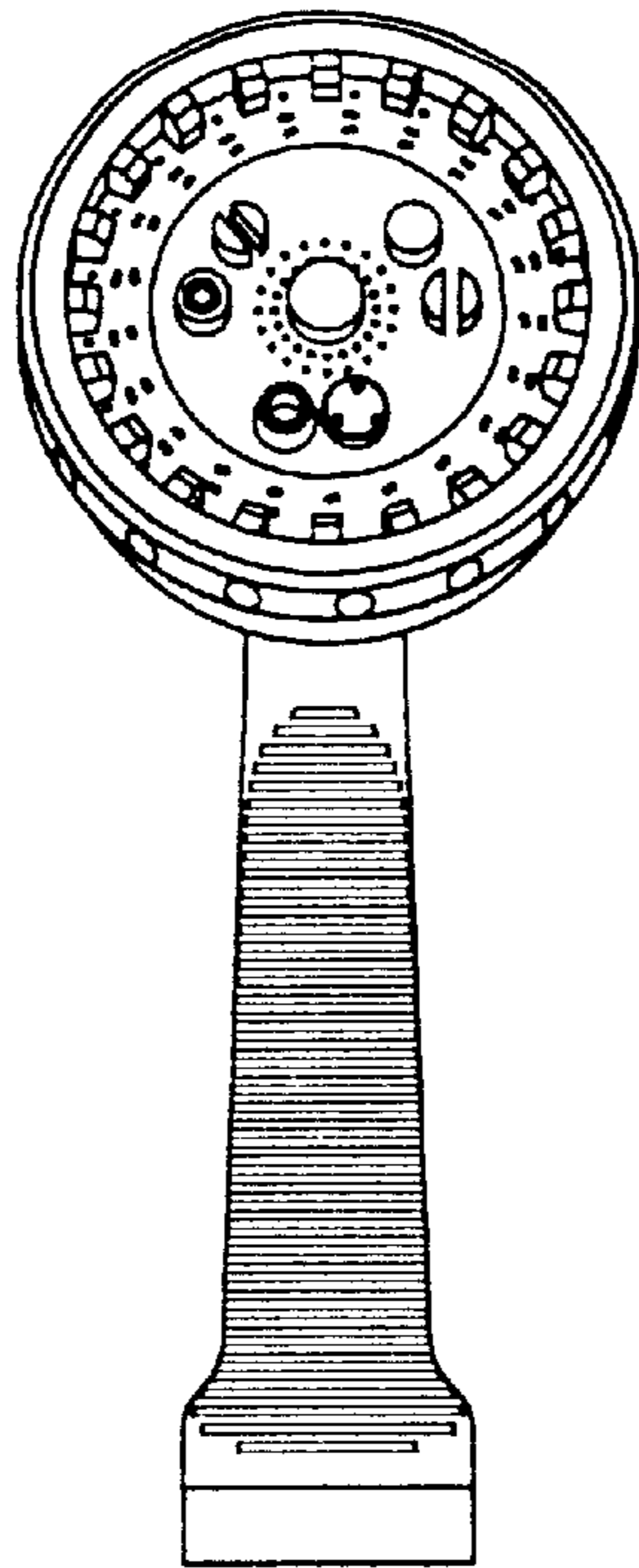

FIG. 2

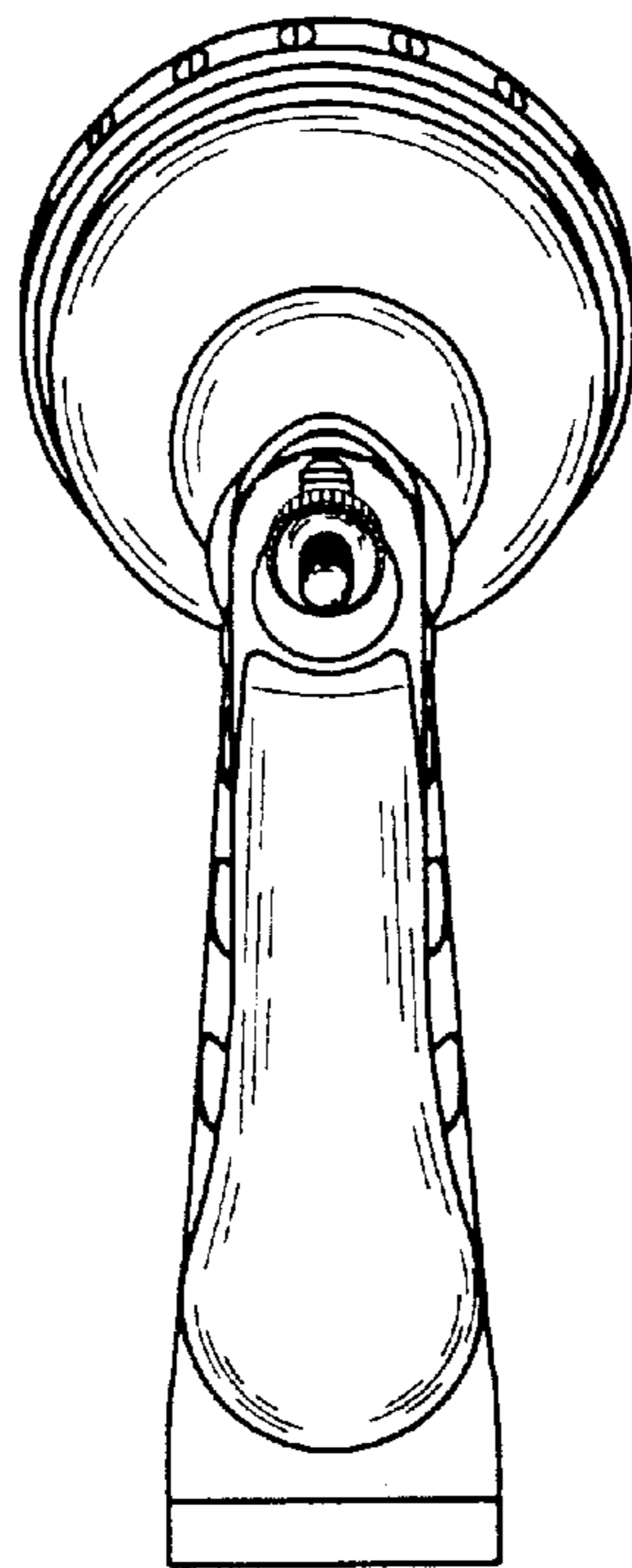

FIG. 3

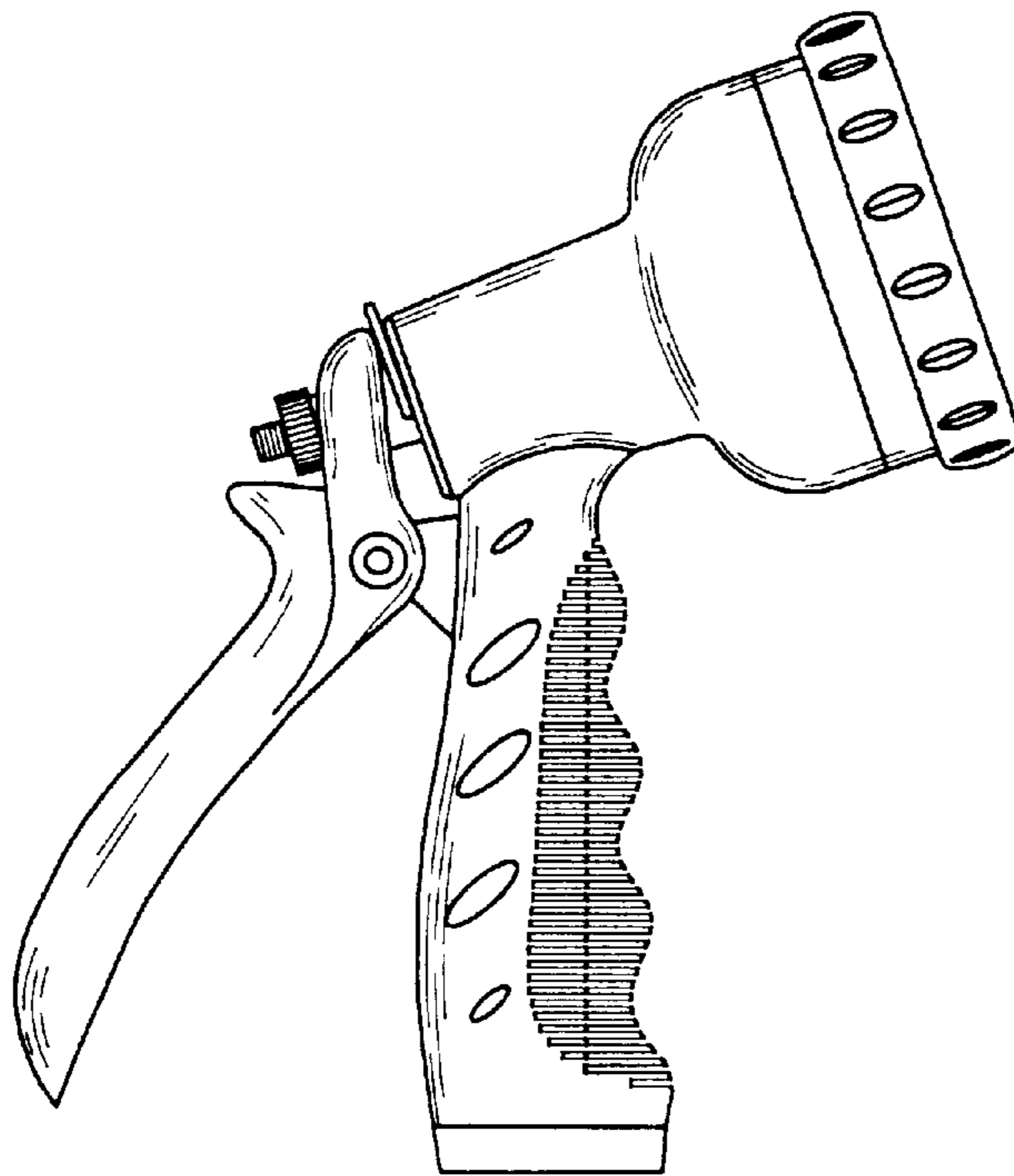

FIG. 4

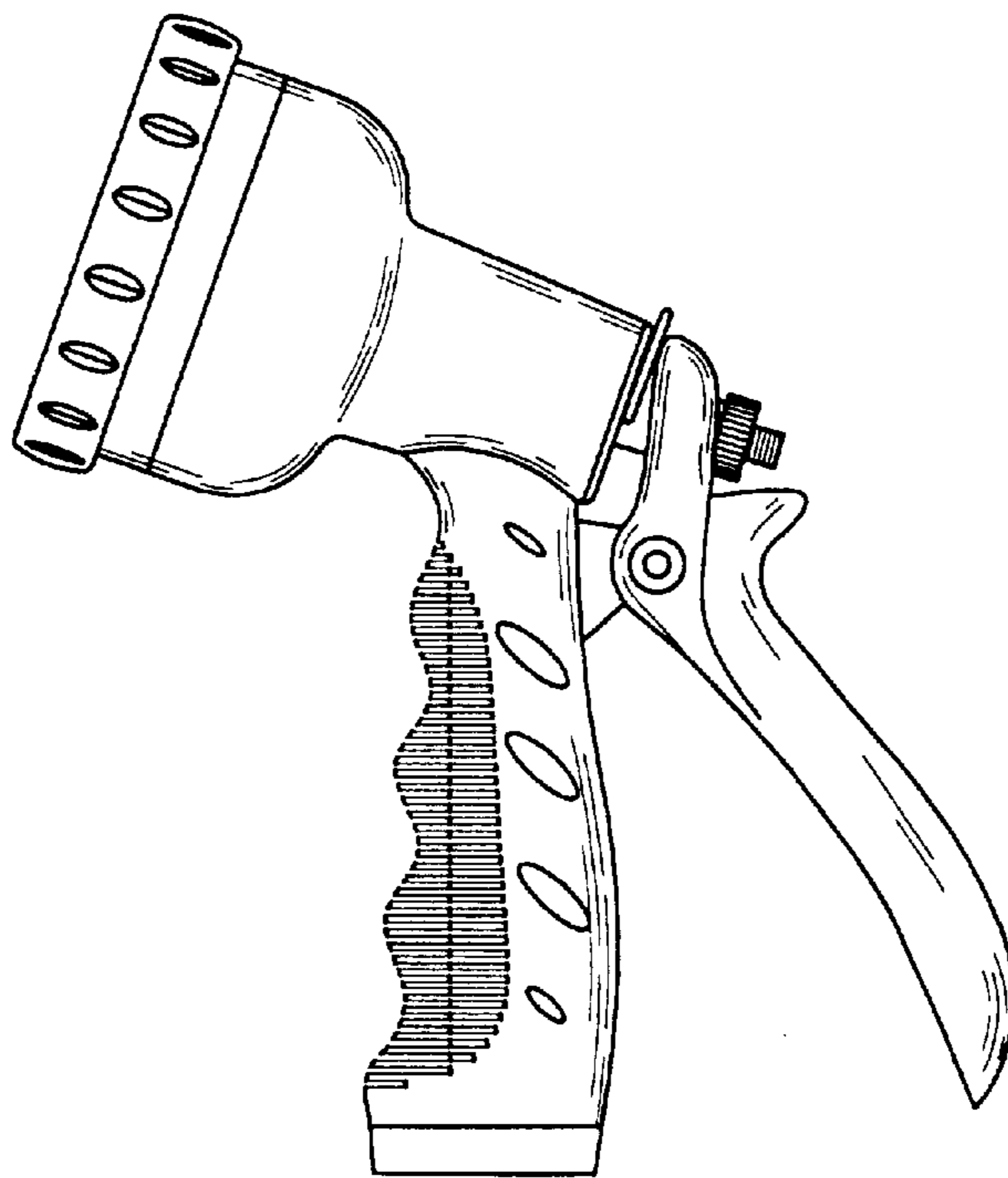

FIG. 5

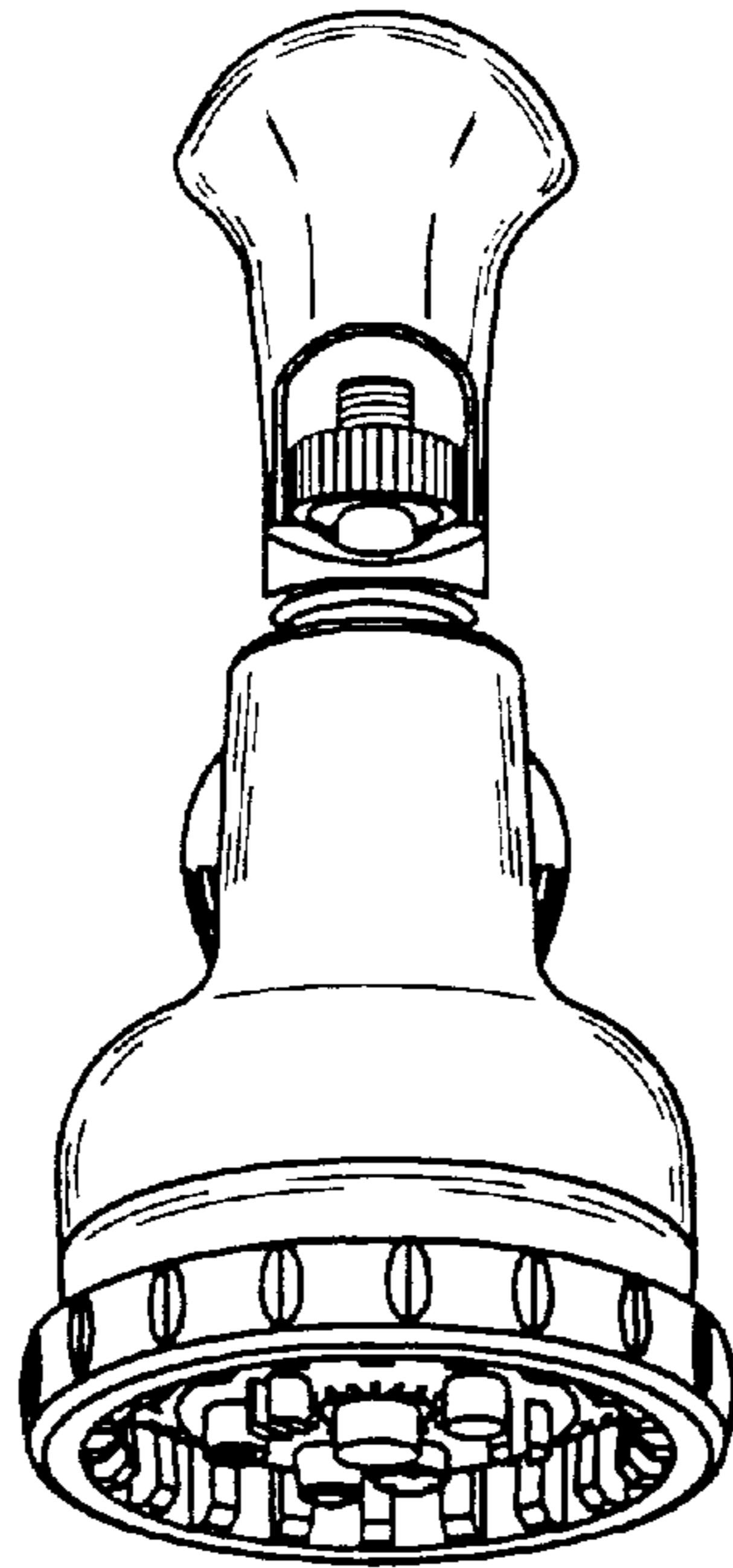

FIG. 6

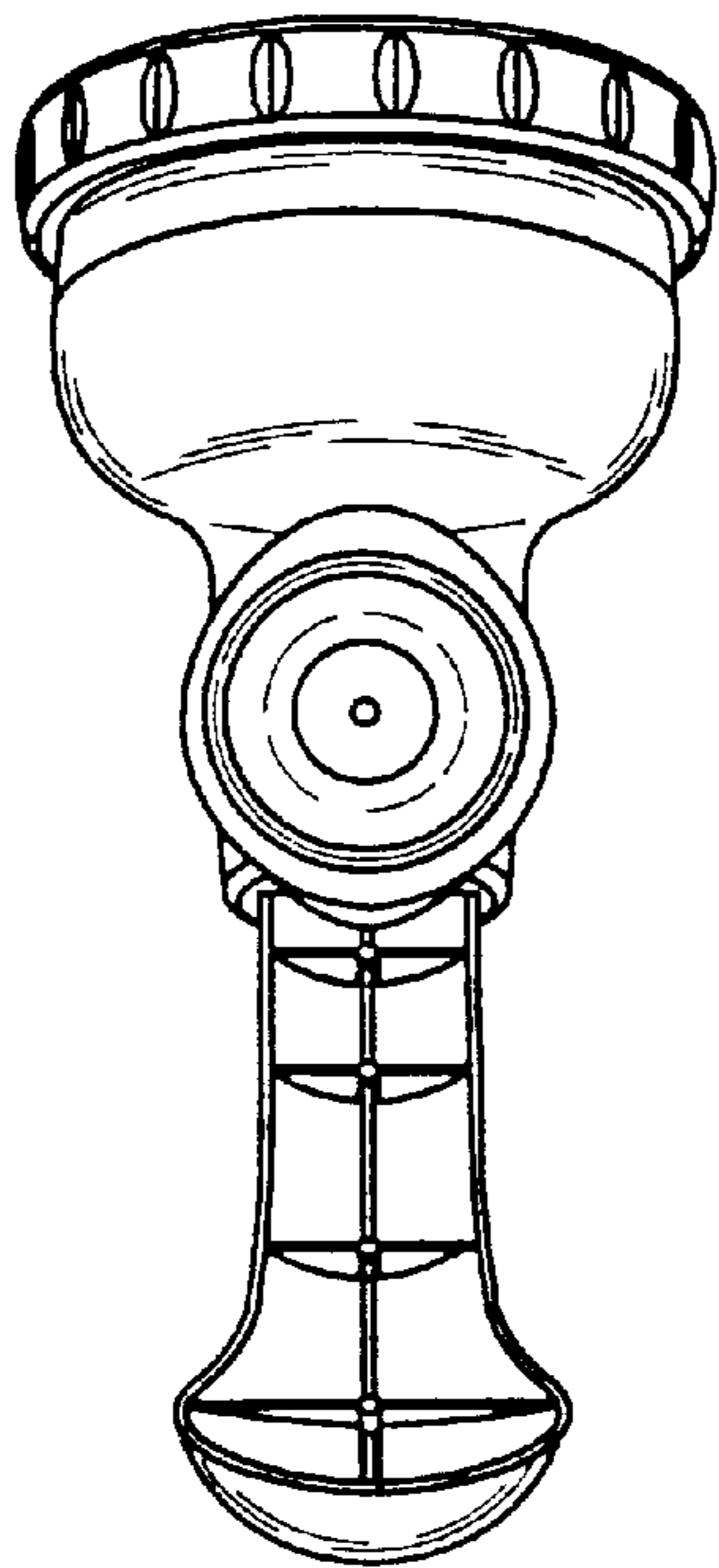

FIG. 7