



US00D470123S

(12) **United States Design Patent**
Hlas et al.

(10) **Patent No.:** **US D470,123 S**

(45) **Date of Patent:** **** Feb. 11, 2003**

(54) **HEADPHONE**

(75) Inventors: **Kevin Hlas**, Portland, OR (US);
Dominic Amae, Vancouver, WA (US);
Raymond Weikel, Camas, WA (US);
Robert Jacobson, Camas, WA (US);
Steven Jensen, Vancouver, WA (US);
Omer Kotzer, Portland, OR (US);
Jamian Cobbett, Portland, OR (US);
Aaron David Hayes, Portland, OR (US)

(73) Assignee: **Logitech Europe S.A.**,
Romanel-sur-Morges (CH)

(**) Term: **14 Years**

(21) Appl. No.: **29/161,926**

(22) Filed: **Jun. 5, 2002**

(51) **LOC (7) Cl.** **14-01**

(52) **U.S. Cl.** **D14/205**

(58) **Field of Search** D14/188, 192,
D14/205, 206, 223, 225, 226, 227, 228,
229; 181/129, 130; 379/430, 433; 381/370,
376, 377, 381

(56) **References Cited**

U.S. PATENT DOCUMENTS

D176,810 S * 1/1956 Norris D14/192

D177,346 S * 4/1956 Norris D14/192
D284,859 S * 7/1986 Okada D14/192
D293,107 S * 12/1987 Müller D14/205
D452,857 S * 1/2002 Hong D14/223
D457,154 S * 5/2002 Ng D14/192
D461,791 S * 8/2002 Ma D14/206

* cited by examiner

Primary Examiner—Paula A. Mortimer
(74) *Attorney, Agent, or Firm*—Ipsolon LLP

(57) **CLAIM**

The ornamental design for a headphone, as shown and described.

DESCRIPTION

FIG. 1A is a front perspective view of a headphone showing our new design;

FIG. 1B is a back perspective view thereof;

FIG. 2 is a front elevation view thereof;

FIG. 3 is a left side elevational view thereof;

FIG. 4 is a right side elevational view thereof;

FIG. 5 is a top elevational view thereof;

FIG. 6 is a bottom elevational view thereof; and,

FIG. 7 is a back elevation view thereof.

The broken lines showing recesses, vents, ports and a cable extending therefrom are for illustrative purpose only and form no part of the claimed design.

1 Claim, 2 Drawing Sheets

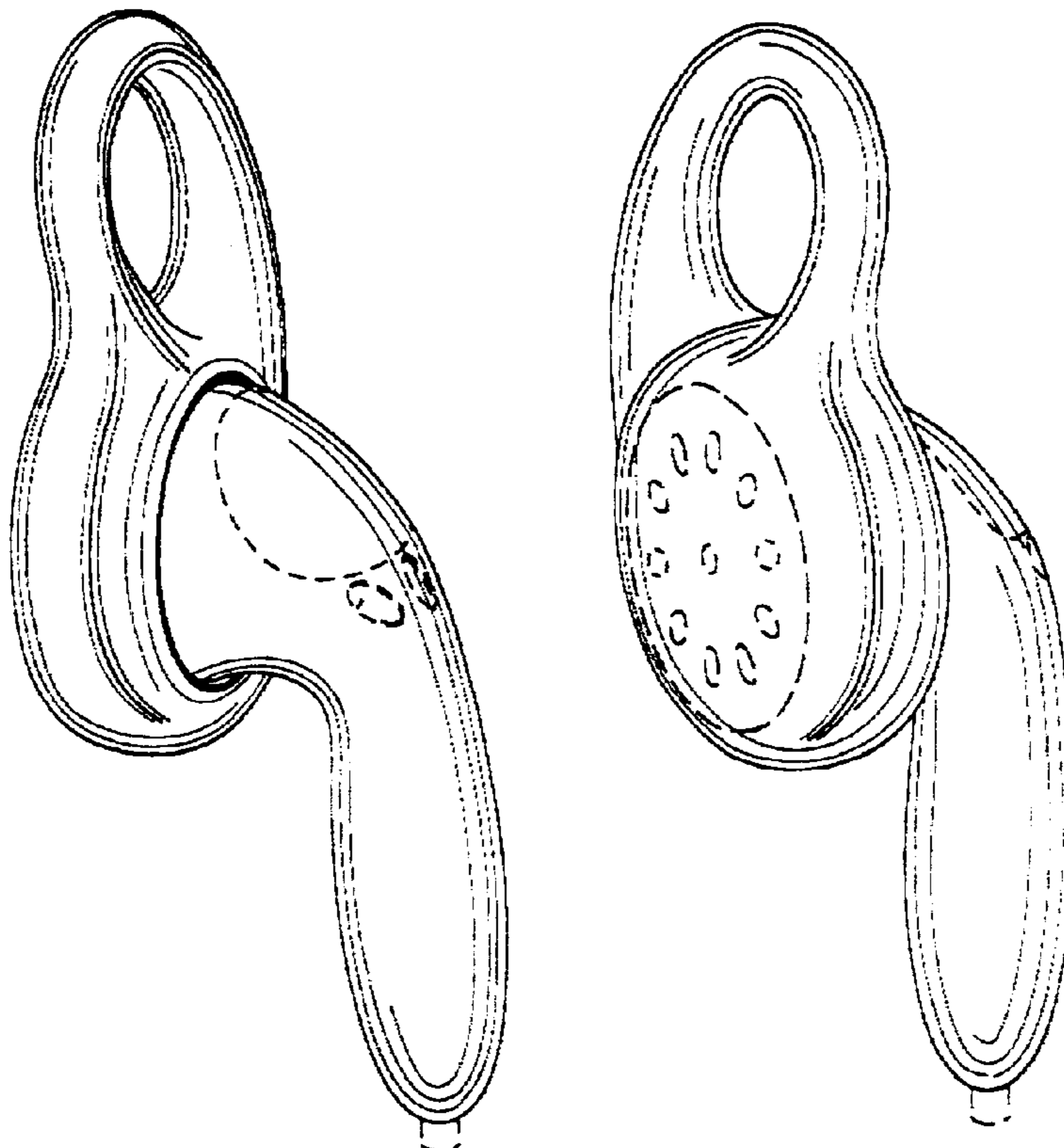

FIG. 1A

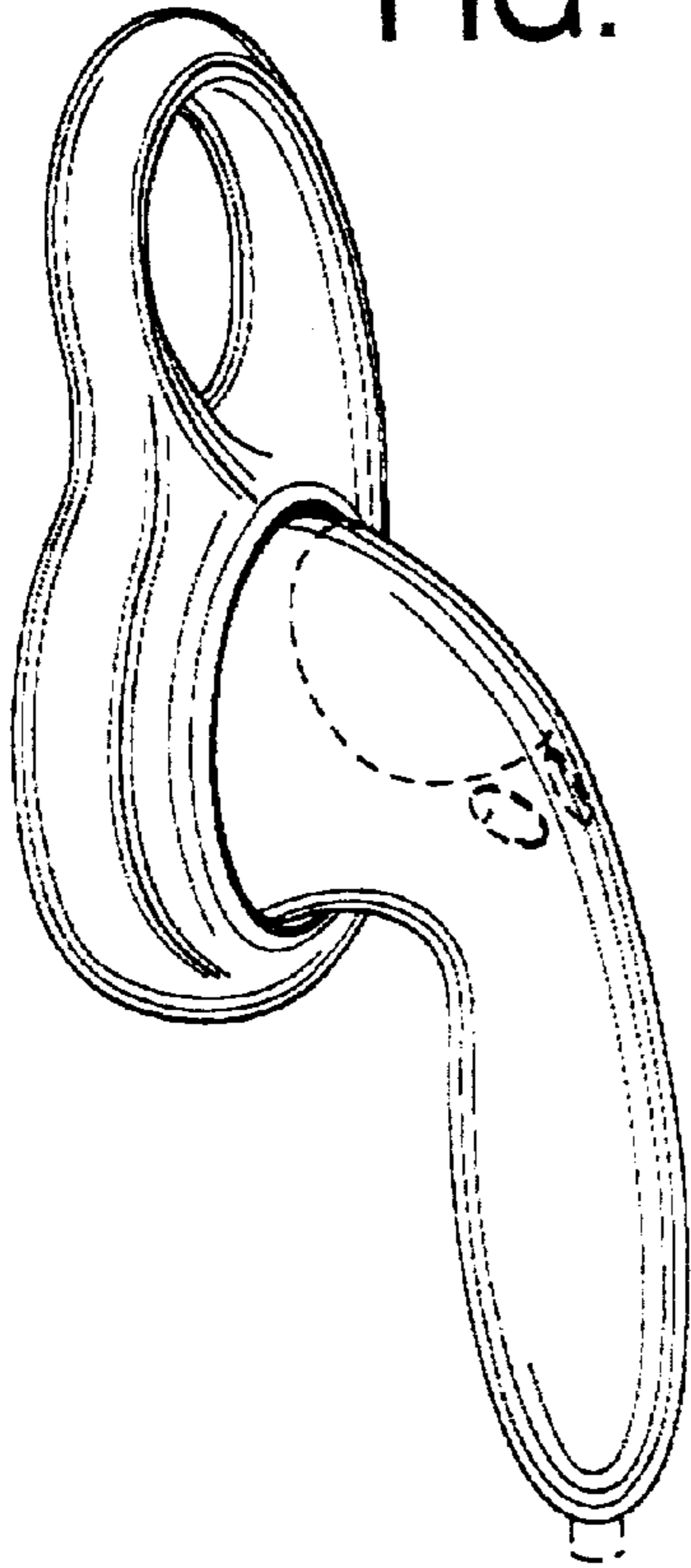

FIG. 1B

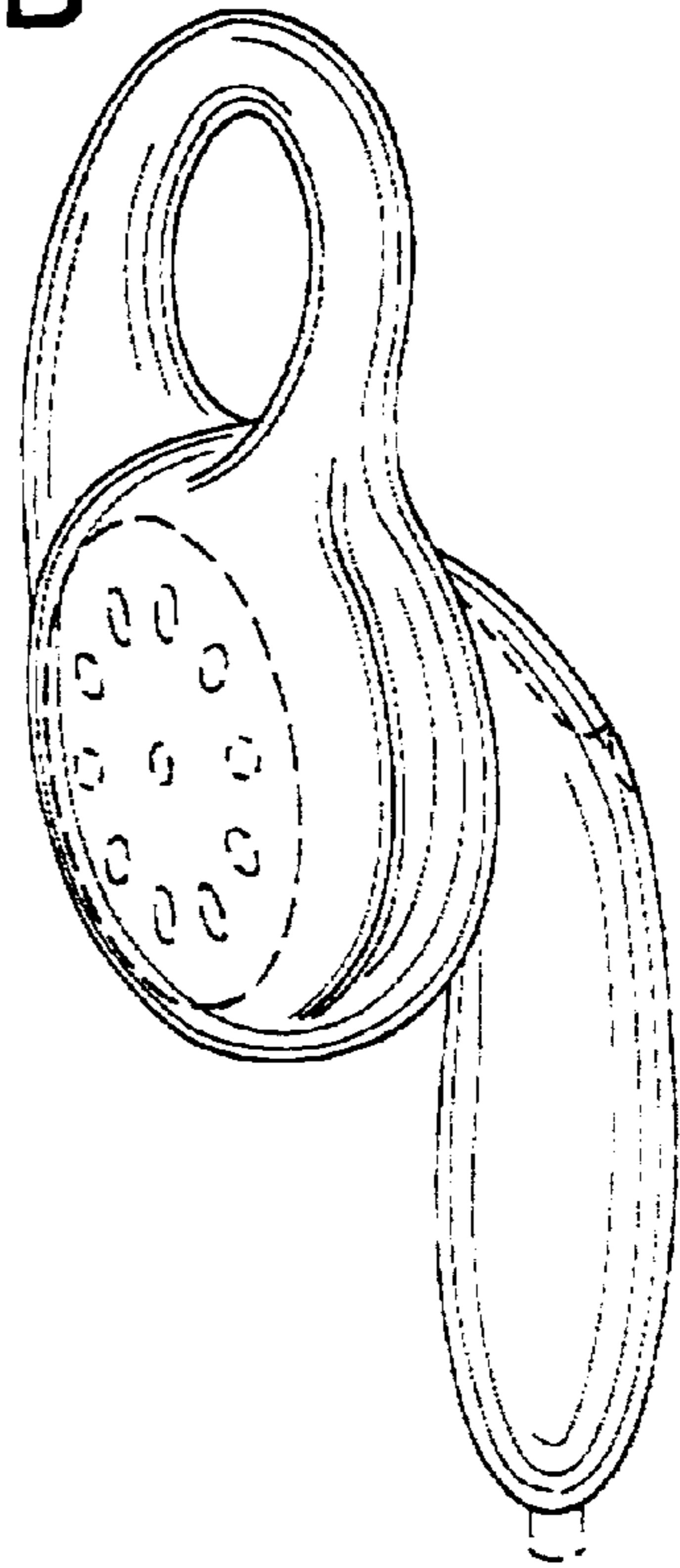

FIG. 7

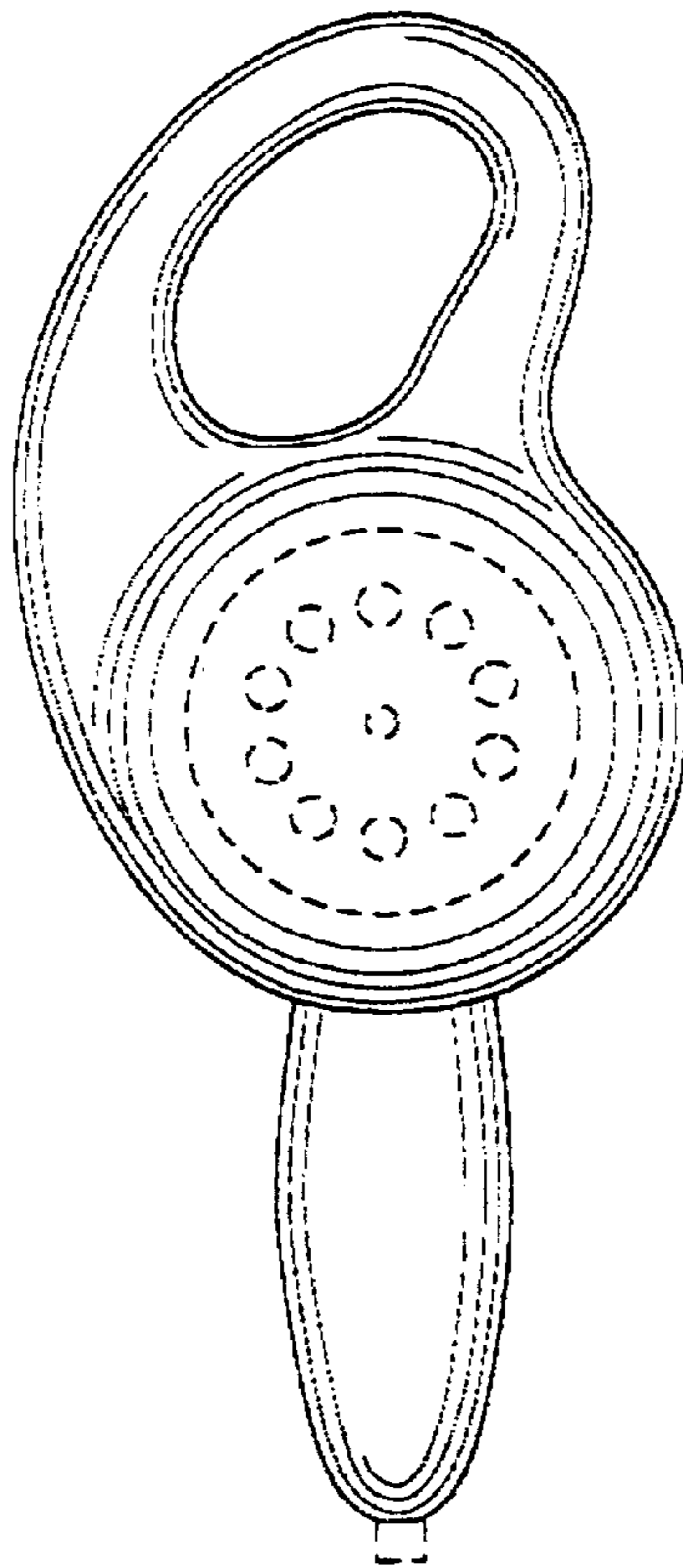

FIG. 5

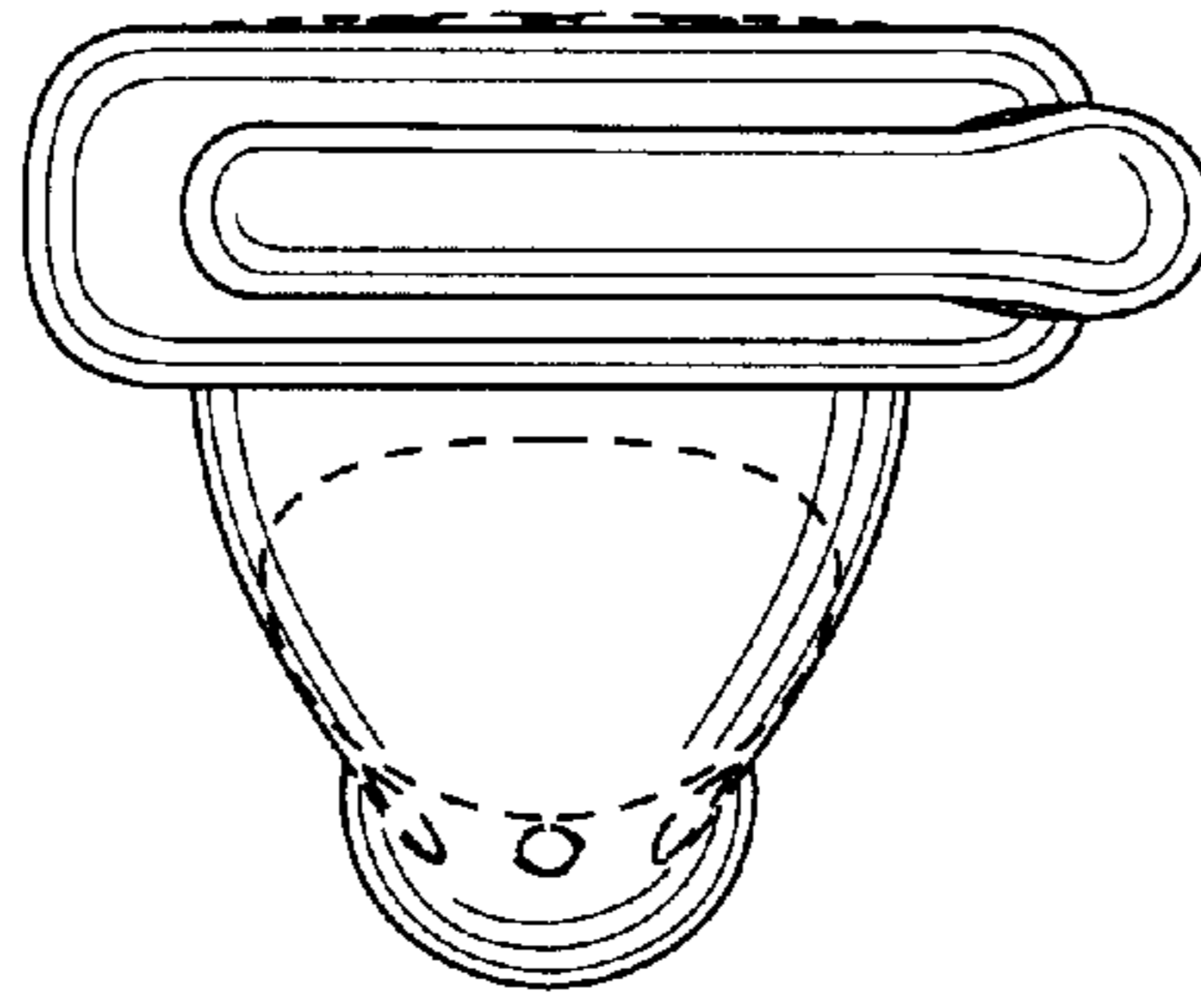

FIG. 3

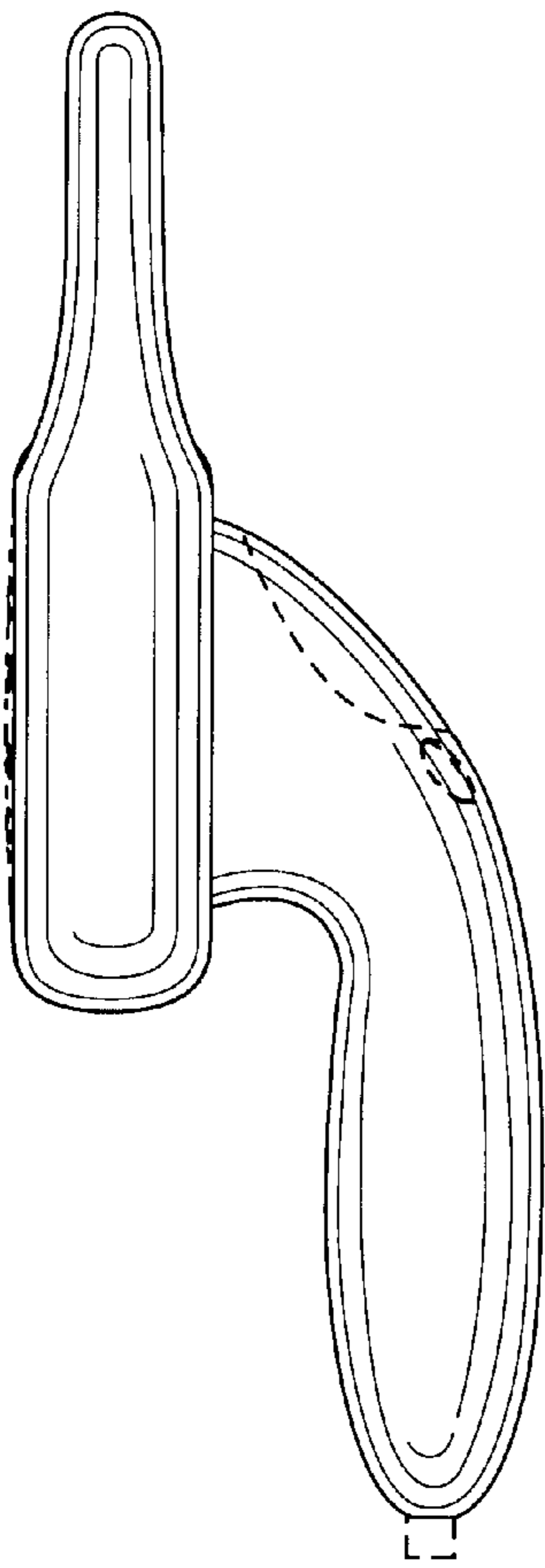

FIG. 2

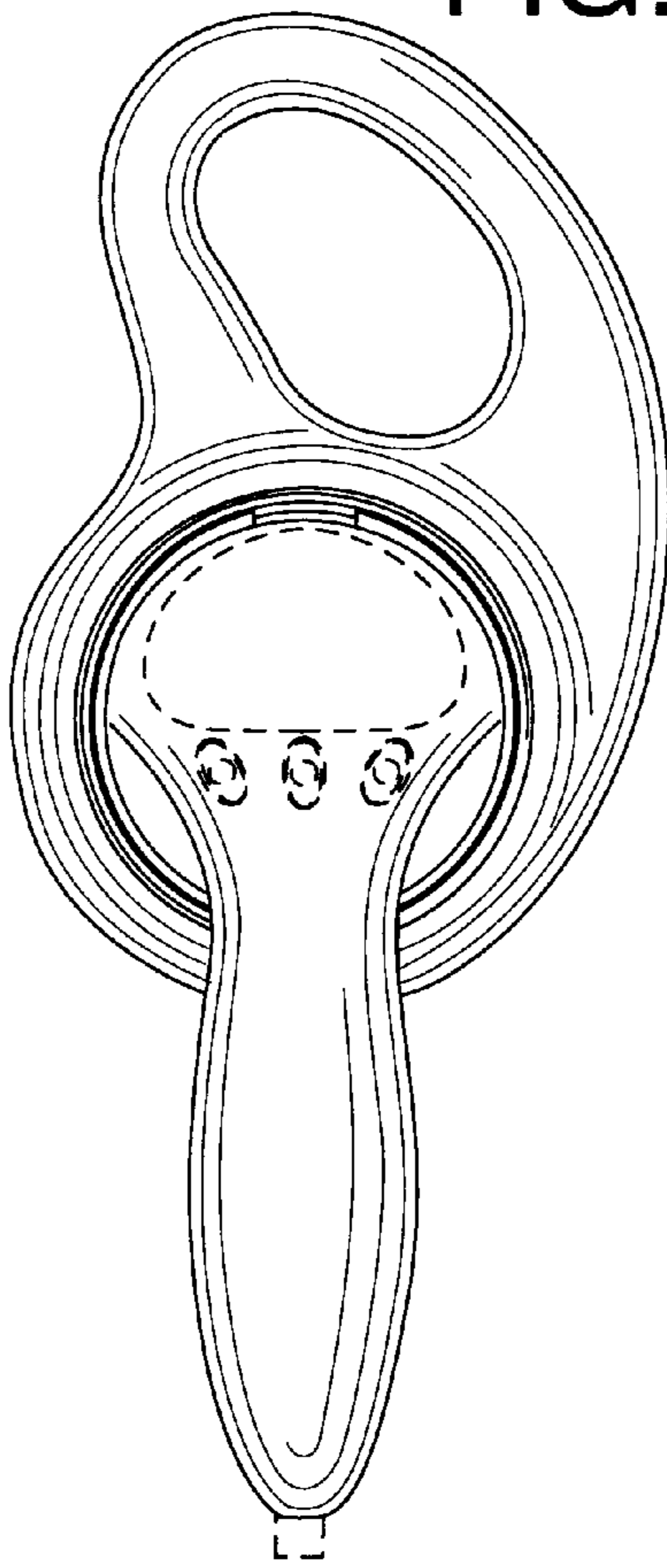

FIG. 4

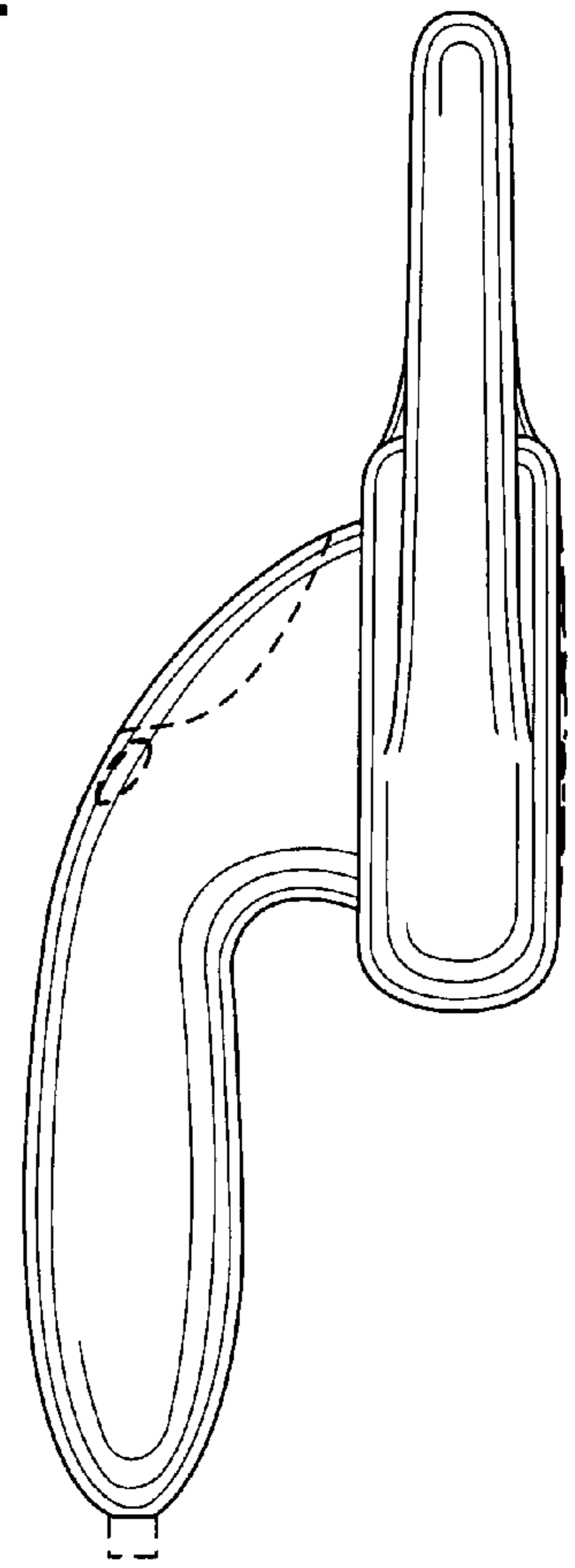

FIG. 6

