



US00D470084S

(12) **United States Design Patent**  
**Schlough et al.**

(10) **Patent No.:** **US D470,084 S**  
(45) **Date of Patent:** **\*\* Feb. 11, 2003**

(54) **CONVERTIBLE STROLLER AND SHOPPING CART HAVING AN 'X' FRAME**

*Primary Examiner*—Marcus A. Jackson  
(74) *Attorney, Agent, or Firm*—Merchant & Gould P.C.

(75) **Inventors:** **Paul A. Schlough**, Andover, MN (US);  
**Gary R. Ebling**, Northfield, MN (US);  
**Jay Stemler**, Otsego, MN (US)

(57) **CLAIM**

The ornamental design for a convertible stroller and shopping cart having an 'X' frame, as shown and described.

(73) **Assignee:** **Pinnacle Design Inc.**, Elk River, MN (US)

**DESCRIPTION**

(\*\*) **Term:** **14 Years**

FIG. 1 is a left-side perspective view of a convertible stroller and shopping cart having an 'X' frame of the present invention.

(21) **Appl. No.:** **29/145,198**

FIG. 2 is a front view of FIG. 1.

(22) **Filed:** **Jul. 18, 2001**

FIG. 3 is a back view of FIG. 1.

(51) **LOC (7) Cl.** ..... **12-12**

FIG. 4 is a side view of FIG. 1; the opposing side is a mirror image of the shown side.

(52) **U.S. Cl.** ..... **D12/129**

FIG. 5 is a top view of FIG. 1.

(58) **Field of Search** ..... D12/129; D34/12-27;  
280/33.991, 33.992, 33.993, 33.994, 33.995,  
33.996, 33.997, 33.998, 47.35

FIG. 6 is a bottom view of FIG. 1.

FIG. 7 is a left-side perspective view of an alternative embodiment of a convertible stroller and shopping cart having an 'X' frame of the present invention illustrating an interchangeable child carrier (in phantom); and,

(56) **References Cited**

**U.S. PATENT DOCUMENTS**

D366,546 S	*	1/1996	Schaub et al.	.....	D12/129
D386,873 S	*	11/1997	Lanflois		
			D'Estaintot et al.	.....	D12/129
D403,621 S	*	1/1999	Spinella	.....	D12/129

FIG. 8 is a left-side perspective view of an alternative embodiment of a convertible stroller and shopping cart having an 'X' frame of the present invention illustrating an interchangeable utility bag (in phantom).

\* cited by examiner

**1 Claim, 8 Drawing Sheets**

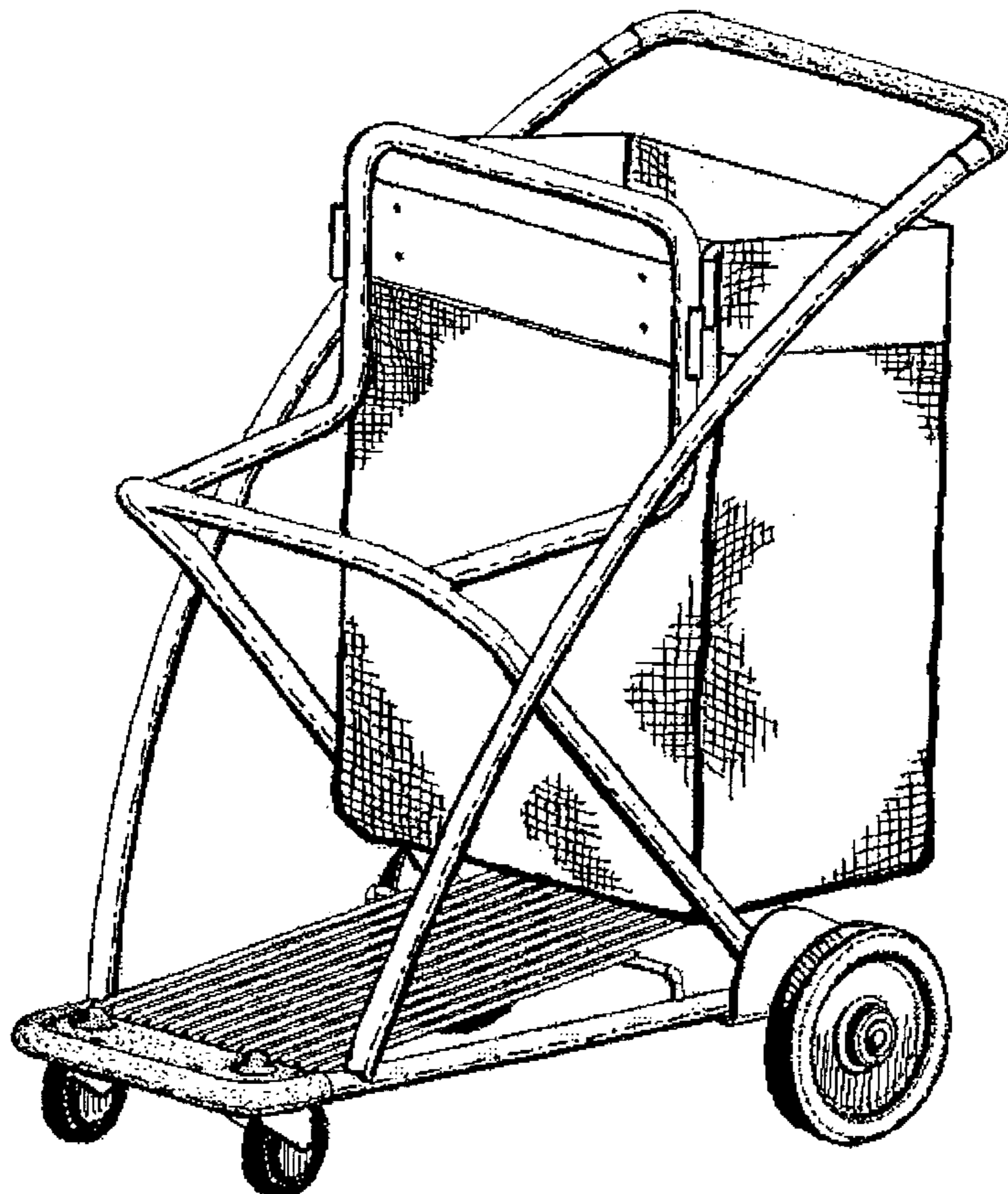

FIG. 1

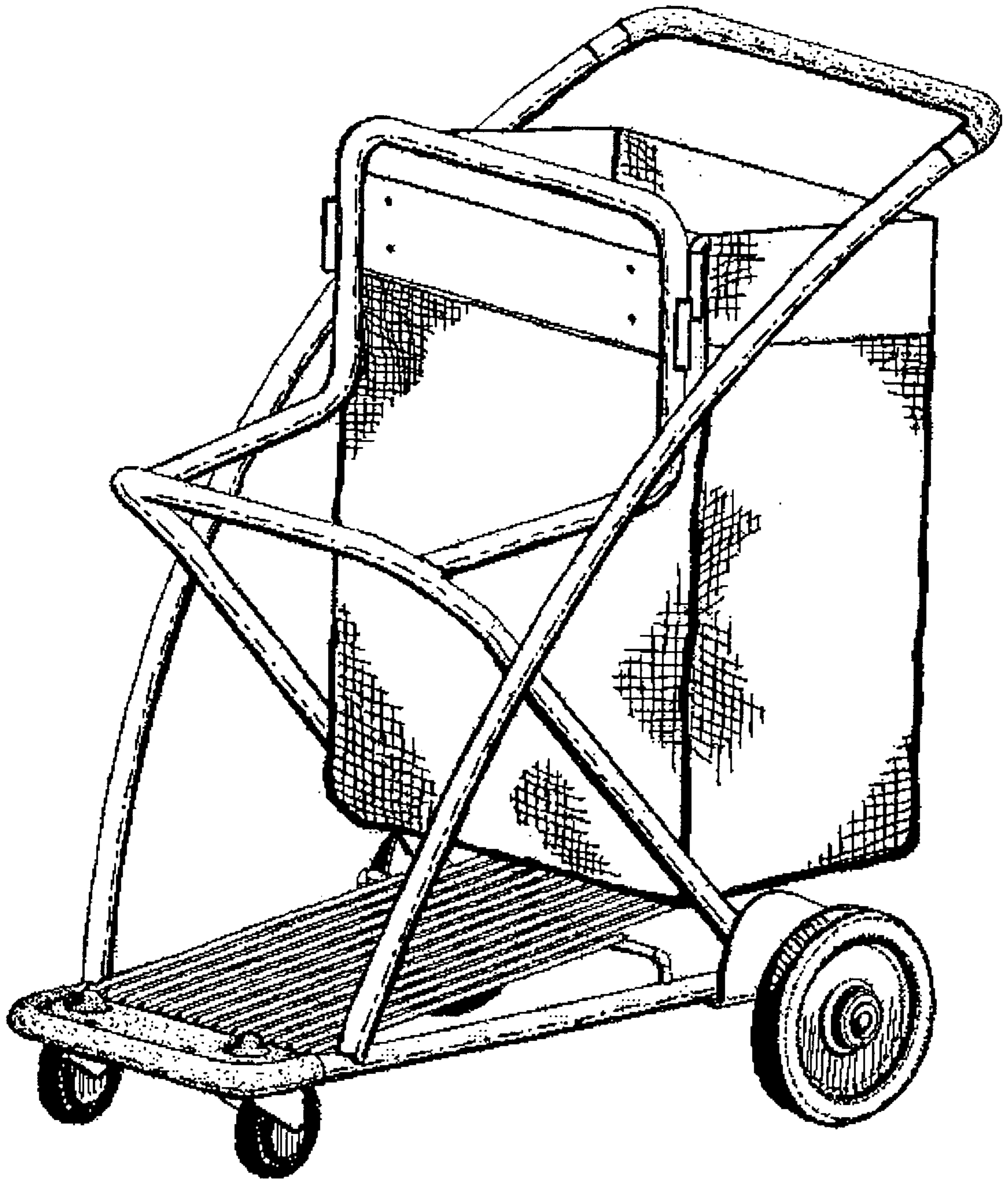

FIG. 2

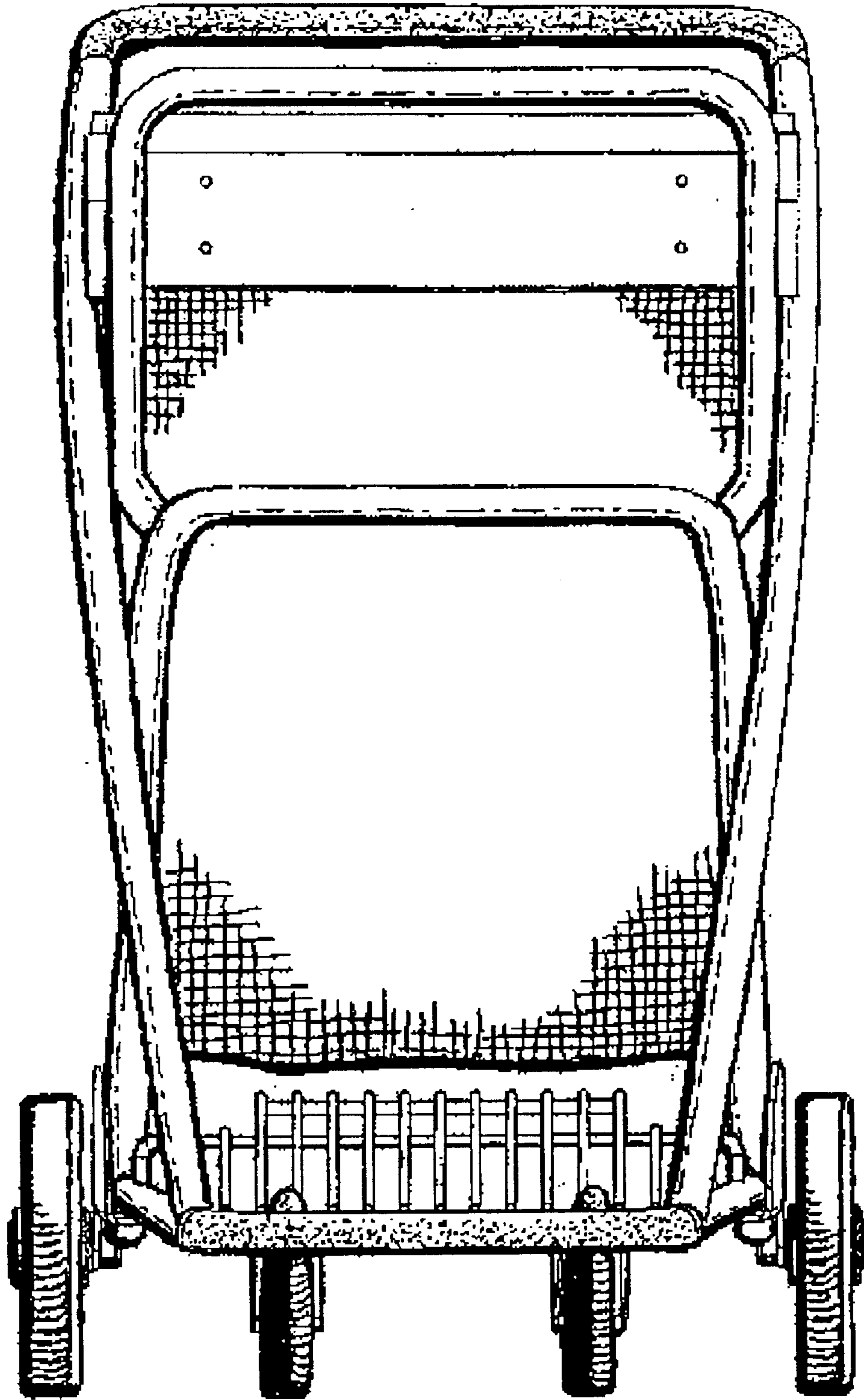

FIG. 3

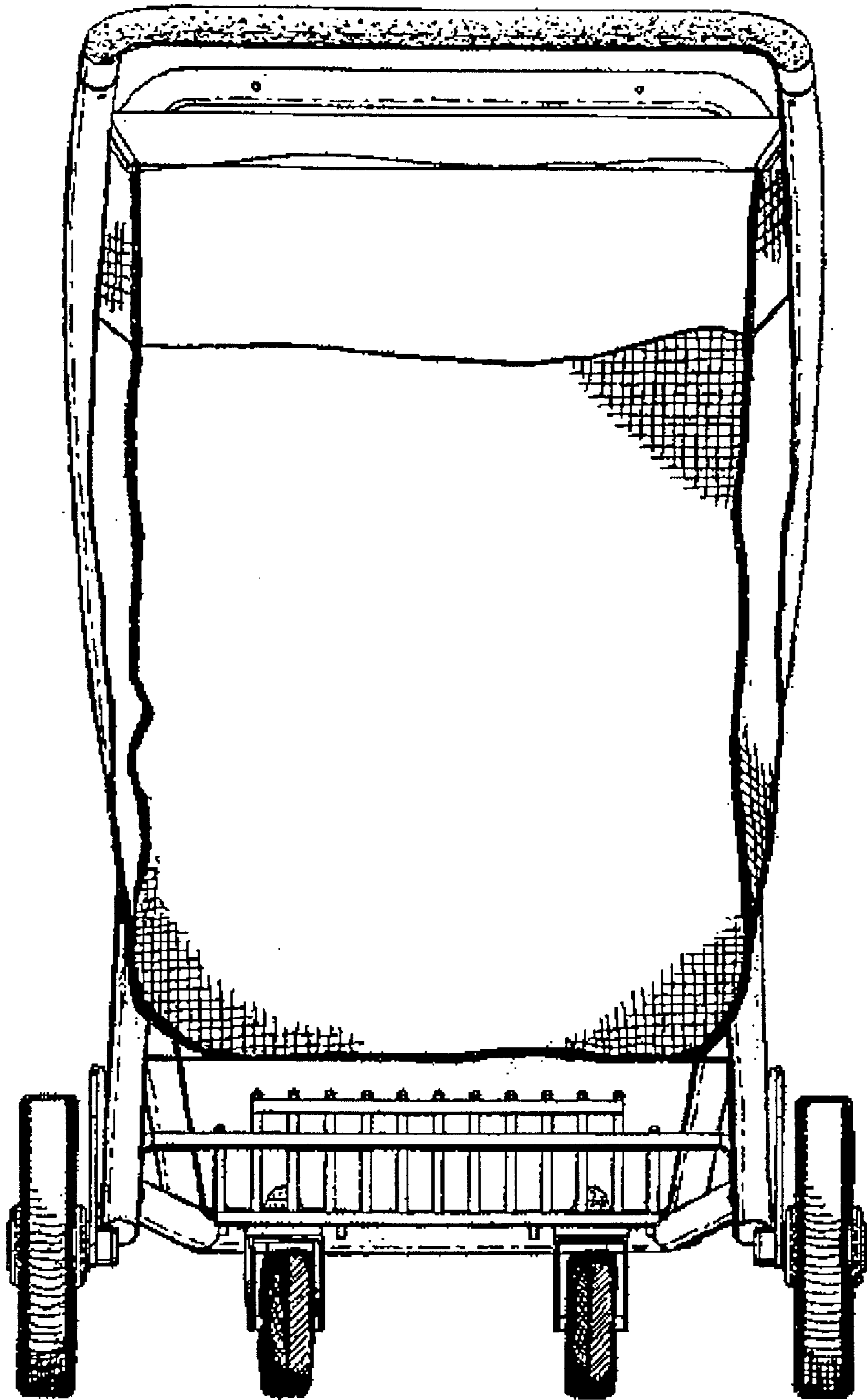

FIG. 4

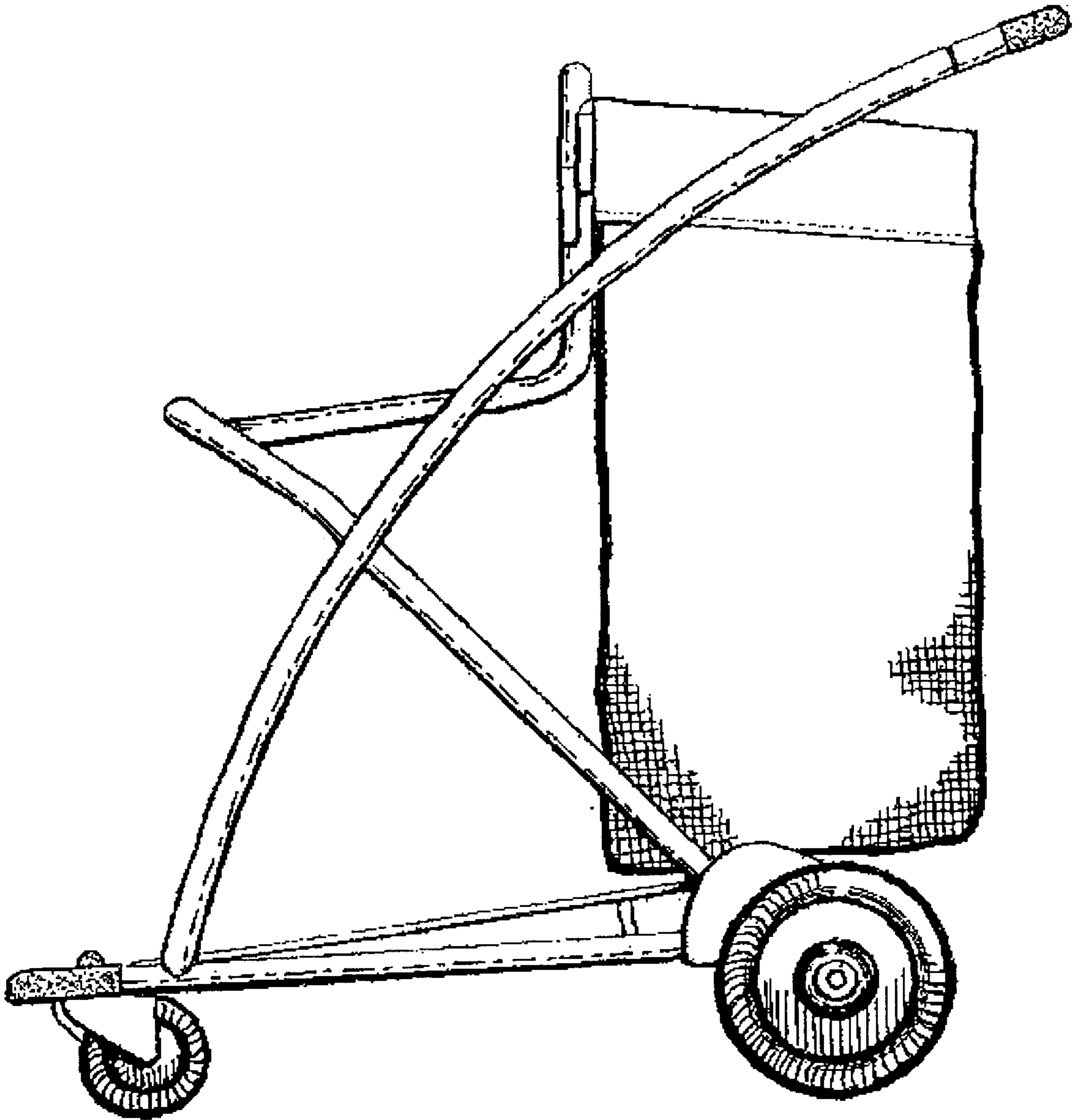

FIG. 5

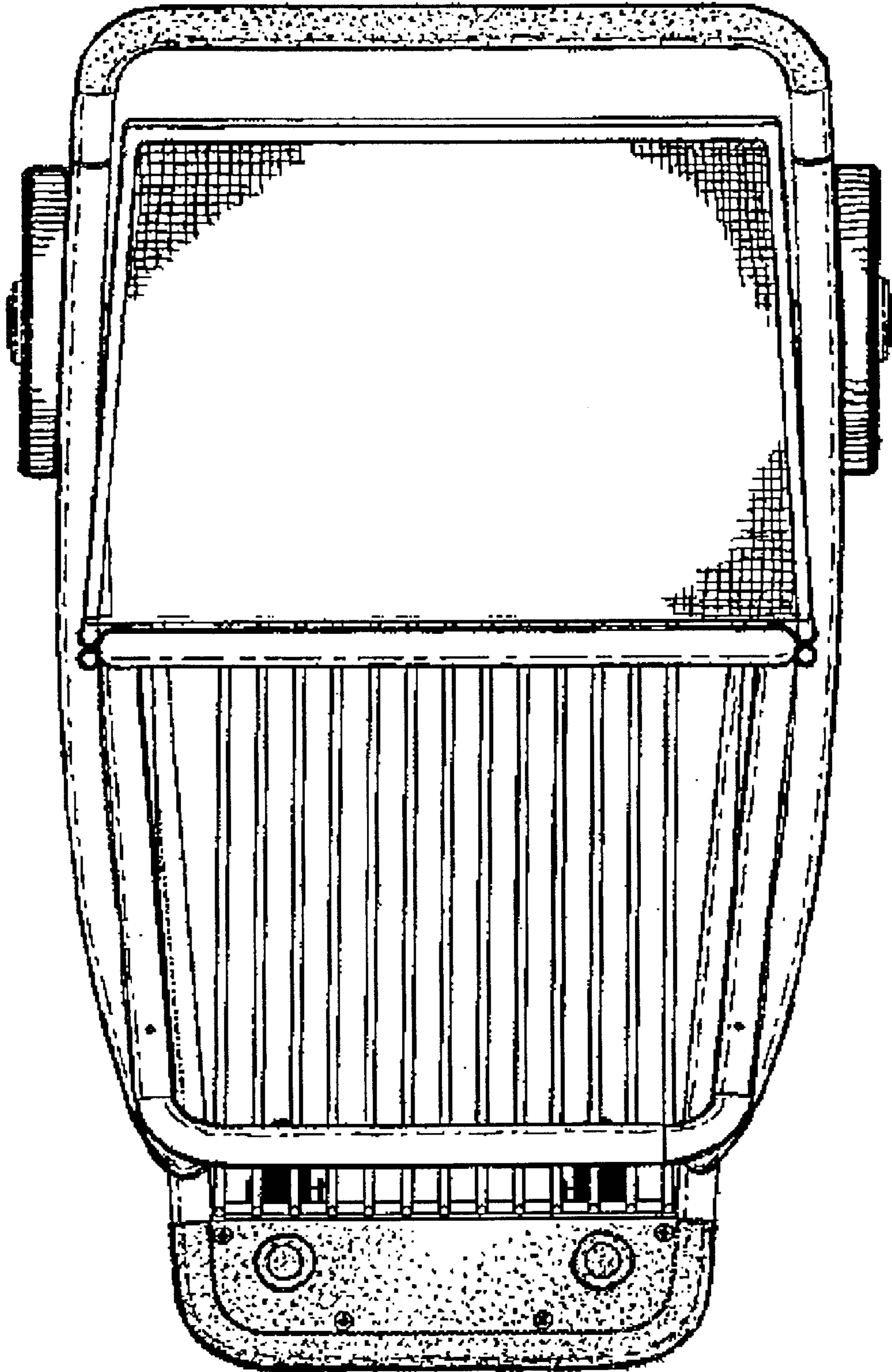

FIG. 6

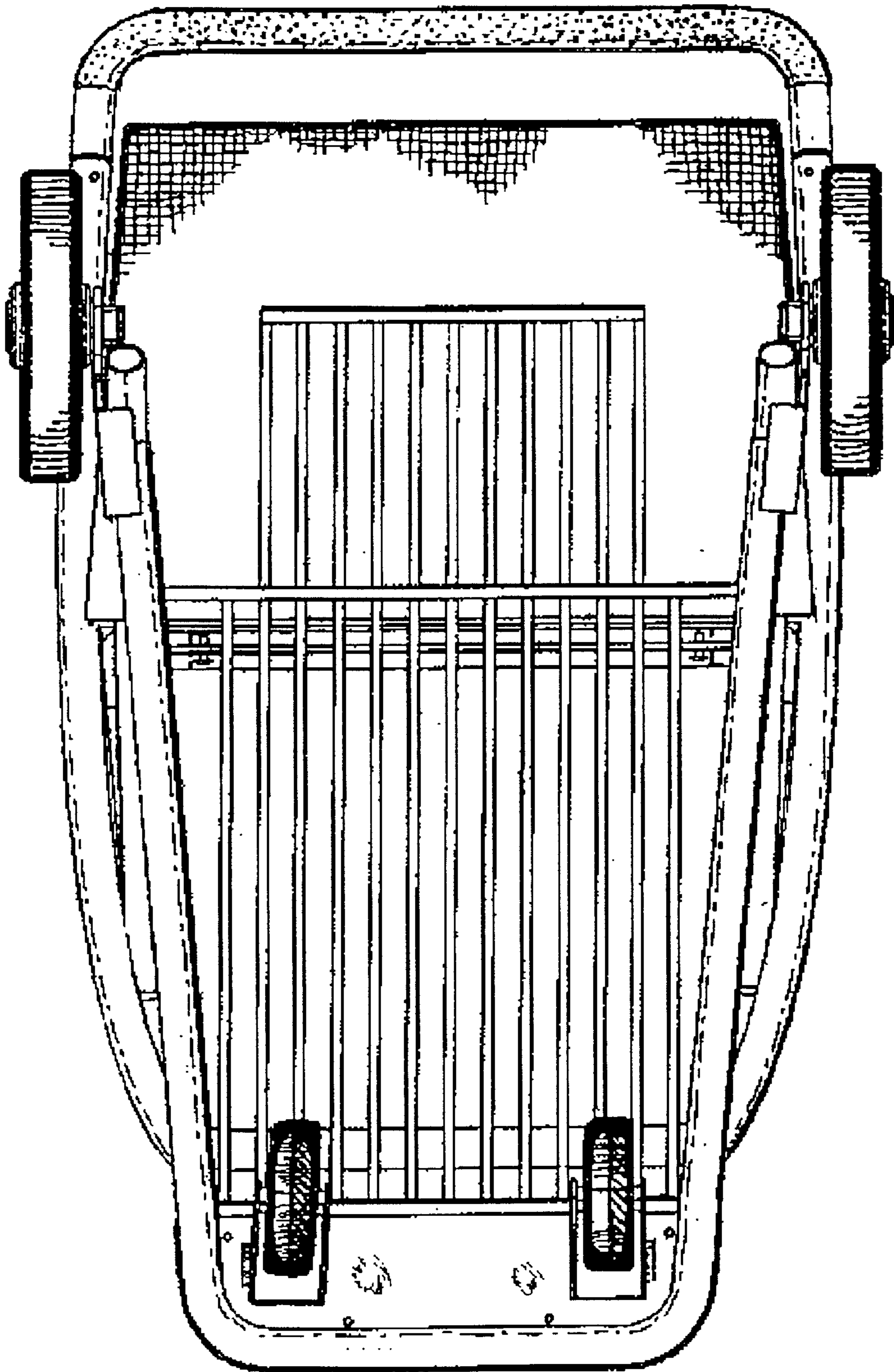

FIG. 7

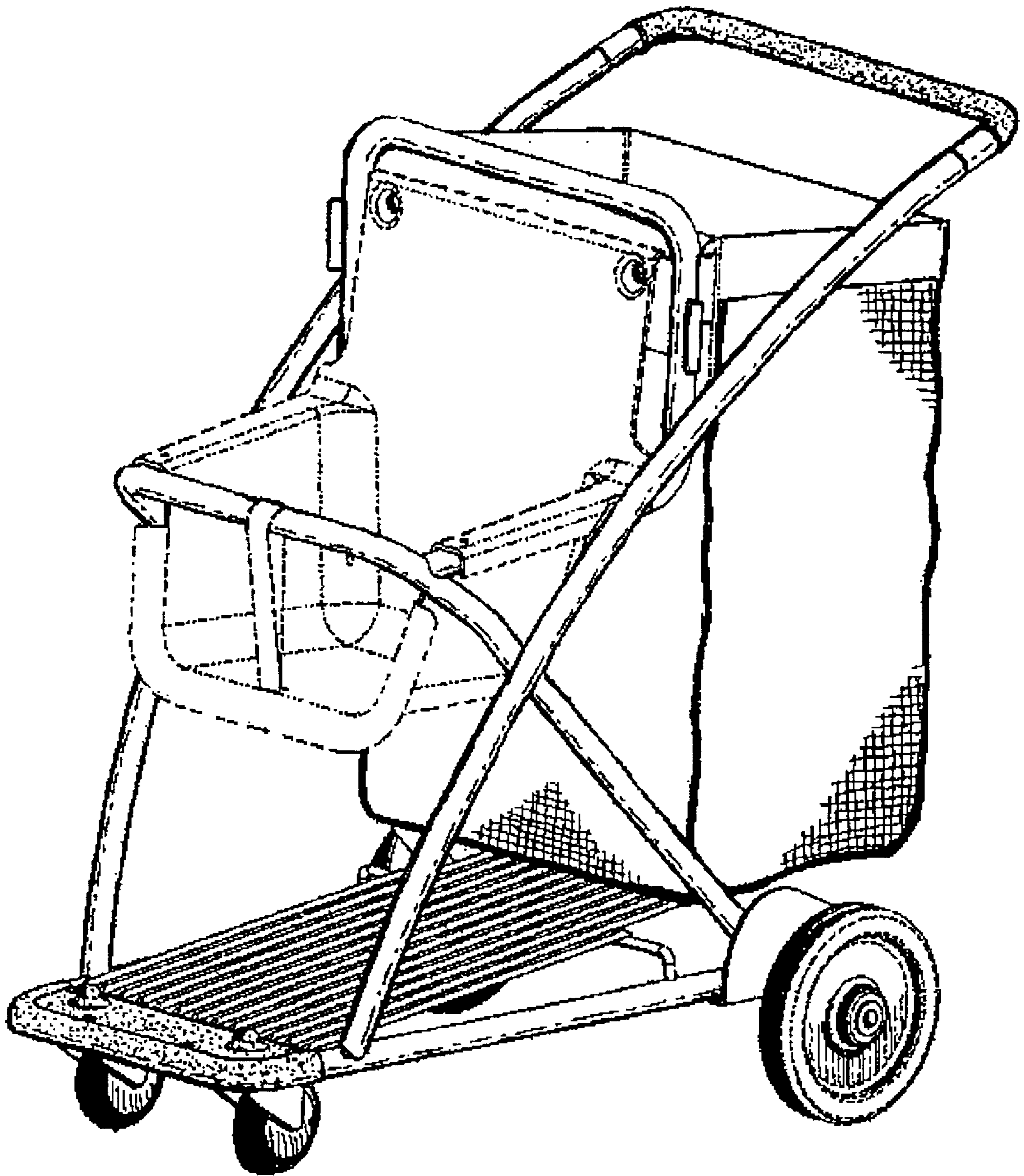



FIG. 8

