



US00D470053S

(12) **United States Design Patent**
Gratz

(10) **Patent No.:** **US D470,053 S**

(45) **Date of Patent:** **** Feb. 11, 2003**

(54) **ROLL SUPPORT**

6,142,440 A 11/2000 Gratz et al. 248/346
6,302,671 B1 10/2001 Gilfert et al. 425/84

(75) Inventor: **Jeffrey J. Gratz**, Hartland, WI (US)

* cited by examiner

(73) Assignee: **Fibreform Containers, Inc.**,
Germantown, WI (US)

Primary Examiner—Dominic Simone

(**) Term: **14 Years**

(74) *Attorney, Agent, or Firm*—Boyle Fredrickson
Newholm Stein & Gratz S.C.

(21) Appl. No.: **29/147,125**

(57) **CLAIM**

(22) Filed: **Aug. 23, 2001**

The ornamental design of a roll support, as shown and described.

(51) **LOC (7) Cl.** **09-07**

DESCRIPTION

(52) **U.S. Cl.** **D9/456**

(58) **Field of Search** D9/434, 456, 499;
206/389, 391, 394, 443

FIG. 1 is an isometric view of a roll support in accordance with the present invention;

FIG. 2 is a top plan view of the roll support of FIG. 1;

FIG. 3 is a side elevational view of the roll support of FIG. 1;

FIG. 4 is an end view of the roll support of FIG. 1;

FIG. 5 is a cross-sectional view taken along line 5—5 of FIG. 2;

FIG. 6 is a cross-sectional view taken along line 6—6 of FIG. 2;

FIG. 7 is an isometric view of the second embodiment of a roll support in accordance with the present invention;

FIG. 8 is a side elevational view of a first side of the roll support of FIG. 7;

FIG. 9 is a side elevational view of a second side of the roll support of FIG. 7; and,

FIG. 10 is an end view of the roll support of FIG. 7.

(56) **References Cited**

U.S. PATENT DOCUMENTS

D172,596 S	*	7/1954	Harper	D9/456
2,715,458 A	*	8/1955	Polglase	206/394
D233,416 S	*	10/1974	Jansen	D9/456
4,195,732 A		4/1980	Bell	206/391
4,435,463 A	*	3/1984	Roellchen	206/391
D301,013 S	*	5/1989	Creaden	D9/456
4,832,196 A		5/1989	Butler	206/391
D381,180 S		7/1997	Schueneman et al.	D34/38
D385,080 S		10/1997	Schueneman et al.	D34/38
D400,441 S	*	11/1998	Warren	D9/456
D403,961 S		1/1999	Warren	D9/456
D408,737 S		4/1999	Warren, Jr.	D9/456
5,899,331 A		5/1999	Warren, Jr.	206/443
5,934,467 A		8/1999	Gilfert et al.	206/391

1 Claim, 4 Drawing Sheets

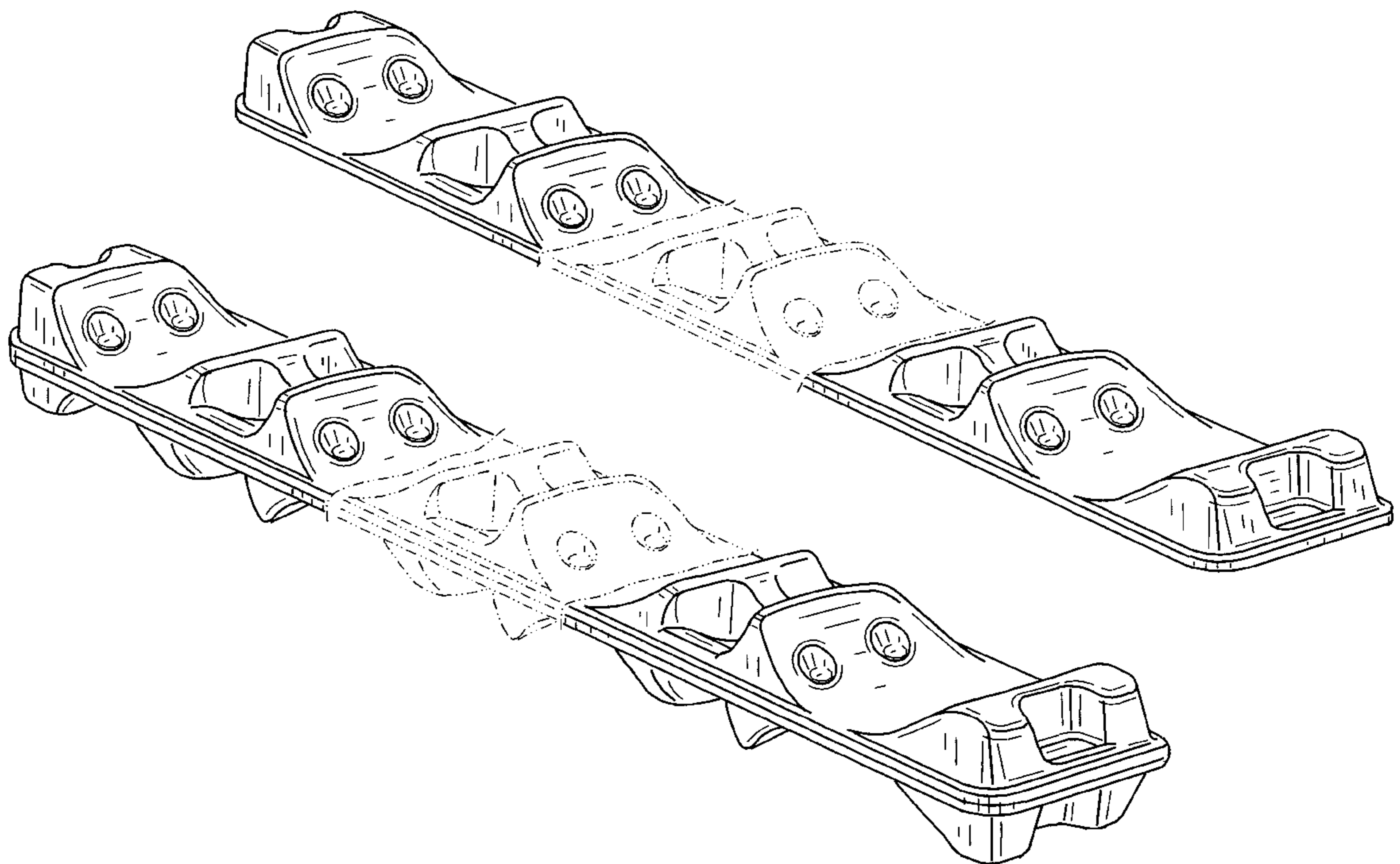

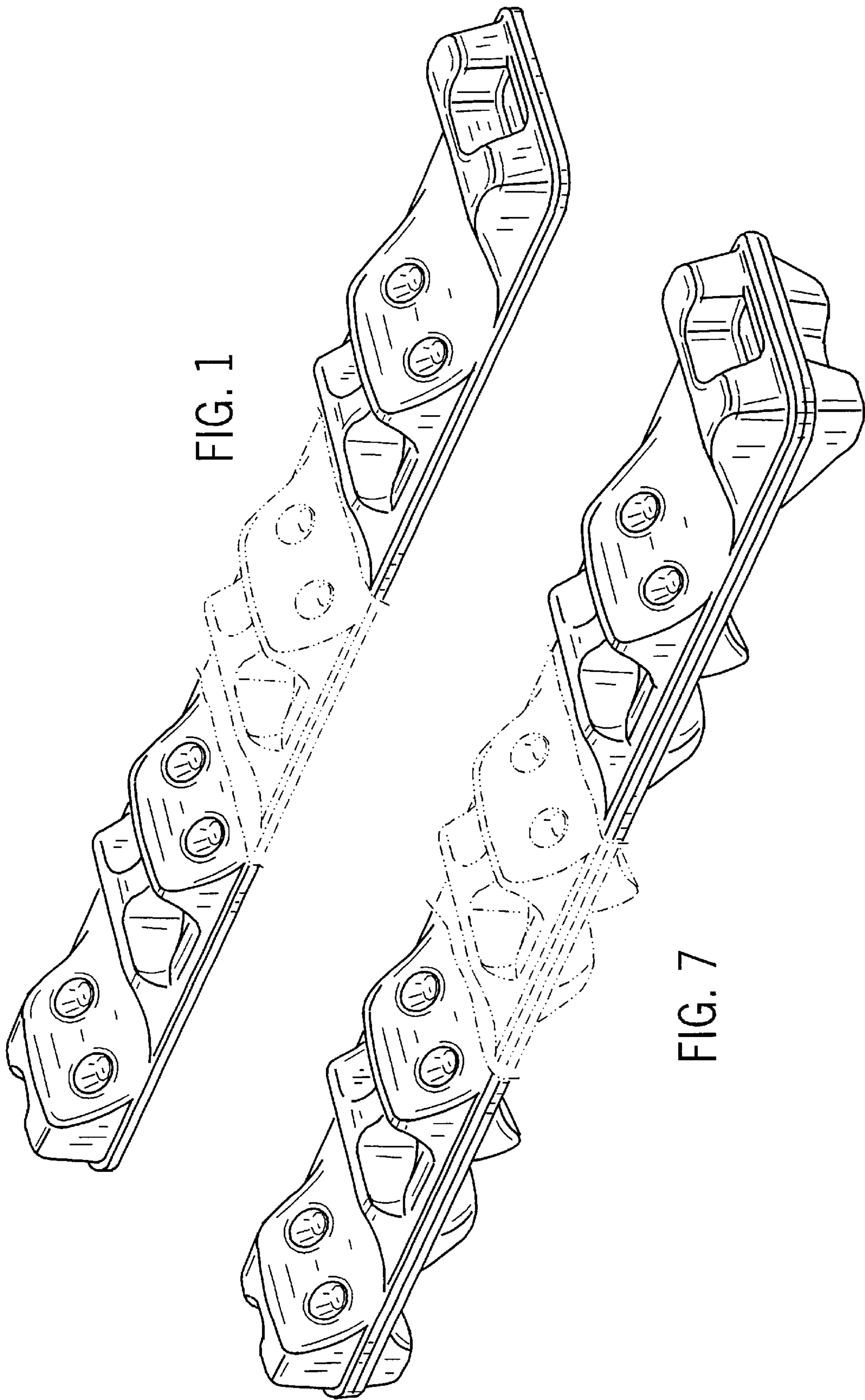

FIG. 1

FIG. 7

FIG. 2

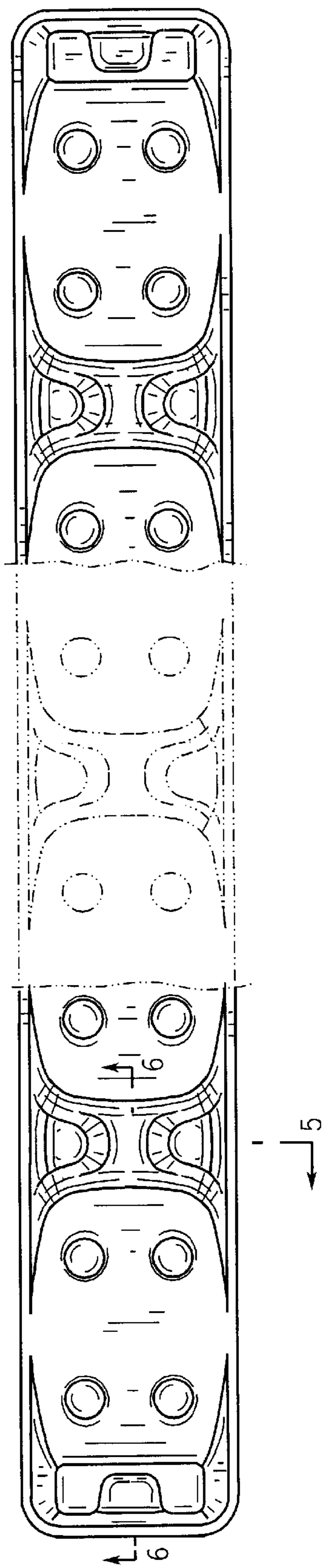

FIG. 3

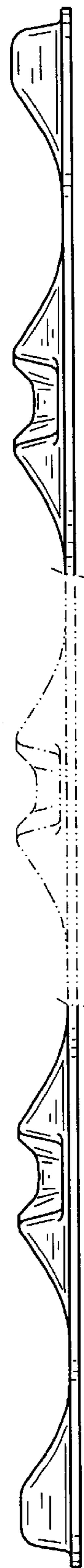

FIG. 4



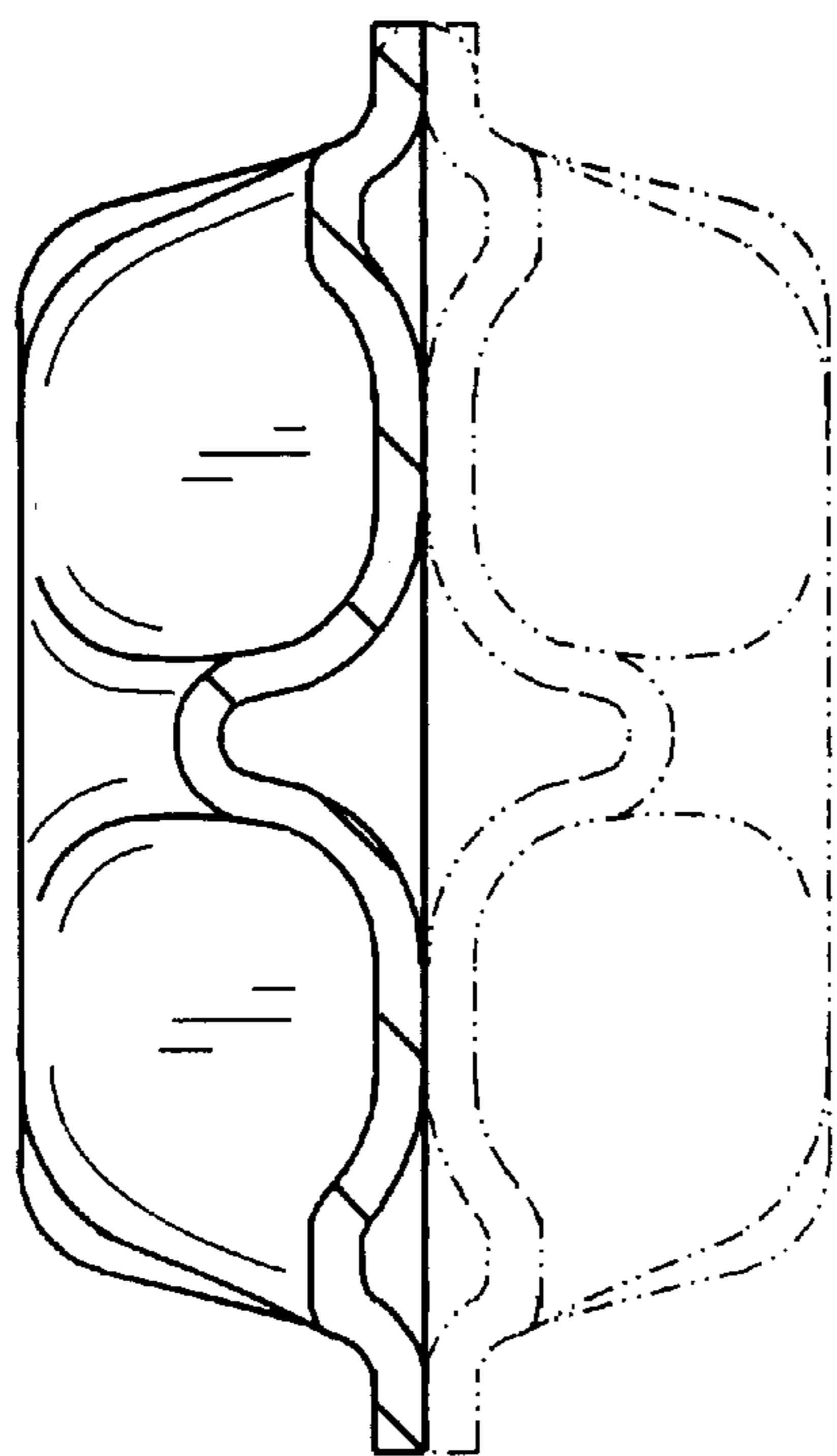

FIG. 5

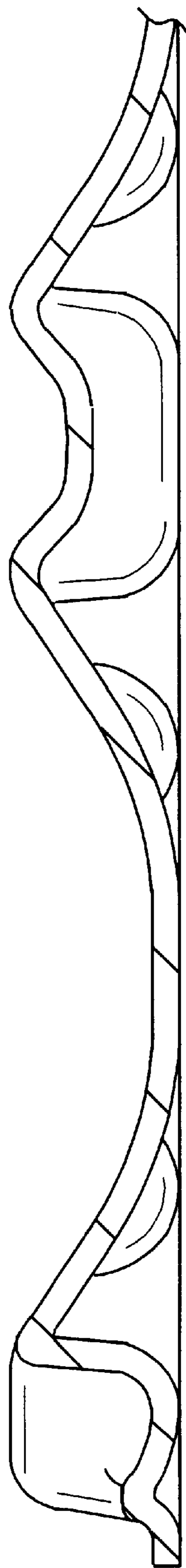

FIG. 6

FIG. 8

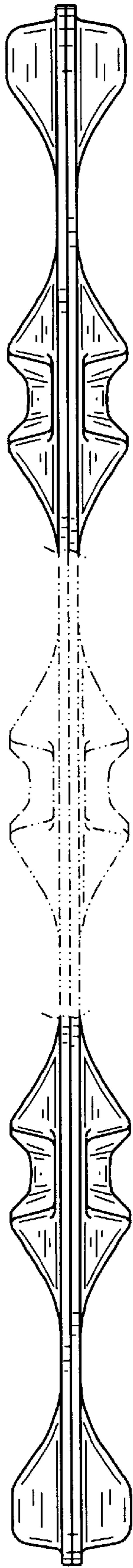

FIG. 9

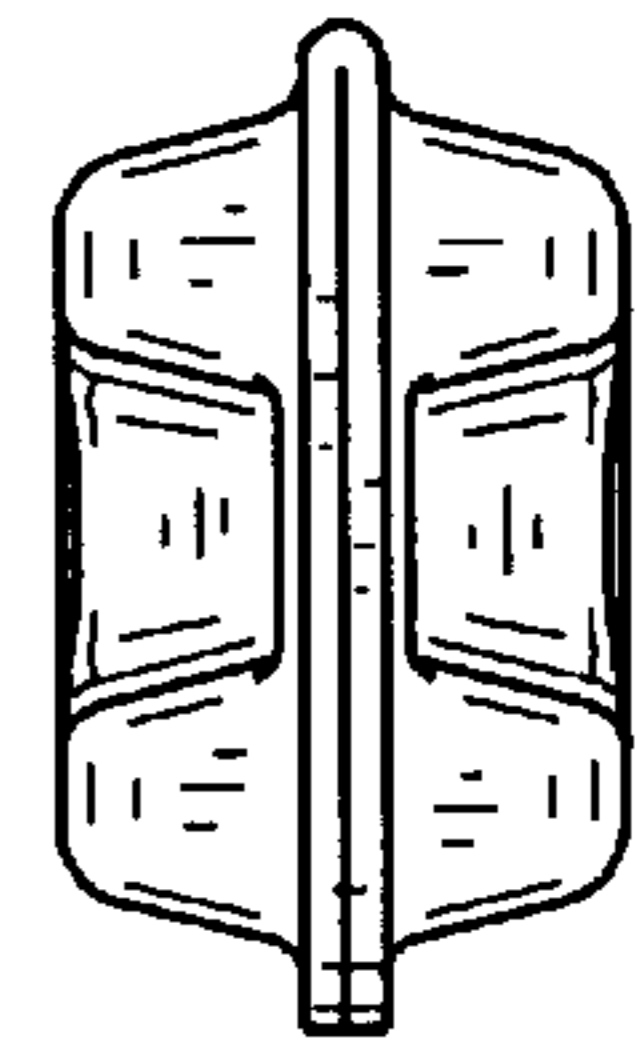
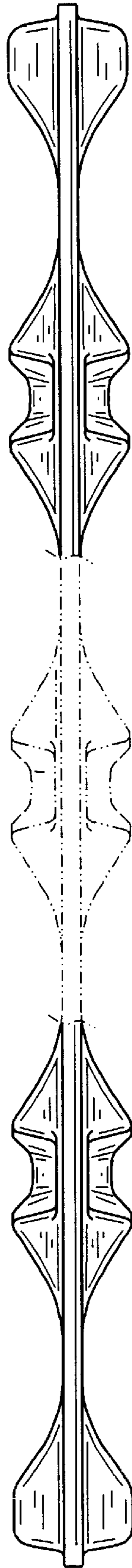

FIG. 10