



US00D470032S

(12) **United States Design Patent**  
**Rivera**

(10) **Patent No.:** **US D470,032 S**

(45) **Date of Patent:** **\*\* Feb. 11, 2003**

(54) **HANDLE FOR A TOOL**

(75) Inventor: **Benjamin C. Rivera**, West Linn, OR (US)

(73) Assignee: **Leatherman Tool Group, Inc.**, Portland, OR (US)

(\*\*) Term: **14 Years**

(21) Appl. No.: **29/155,103**

(22) Filed: **Jan. 30, 2002**

(51) **LOC (7) Cl.** ..... **08-05**

(52) **U.S. Cl.** ..... **D8/107; D8/52; D8/105**

(58) **Field of Search** ..... D8/52, 54-56, D8/105, 106, 107, 98, 99; D27/142; 7/118, 125, 127-135, 165, 167, 168; 30/153, 155; 81/425.7, 415-419, 486, 489, DIG. 9, 177.4, 177.6, 324, 342, 367, 370, 390

(56) **References Cited**

**U.S. PATENT DOCUMENTS**

310,439 A 1/1885 Kamak  
390,633 A \* 10/1888 Weck et al. .... 30/153  
1,282,875 A 10/1918 Kupec

(List continued on next page.)

**FOREIGN PATENT DOCUMENTS**

DE 29556 \* 12/1884  
DE 145784 \* 7/1902  
DE 217 059 \* 1/1909  
EP 0 676 261 A1 \* 10/1995  
EP 0 771 622 A1 \* 5/1997  
EP 0783 937 A2 \* 7/1997  
EP 1 116 557 A2 \* 7/2000  
EP 1 0236 971 A3 \* 8/2000  
FR 89 16842 \* 6/1991  
FR 97 03800 \* 9/1998  
GB 5375 \* 11/1882  
GB 270 186 A \* 5/1927  
GB 947 703 A \* 1/1964  
WO WO 97 19787 \* 6/1997

**OTHER PUBLICATIONS**

Hong Kong Enterprise Catalog, Mar. 1989, p. 12.  
Slip 'n' Snip Collapsible Scissors, at least as early as Oct. 1994.  
Folding Scissors, at least as early as Oct. 1994.  
Leatherman Tool Group, Inc. "The Original Leatherman PST II"—Jul. 1995.  
Coast Cutlery Co., Micro-Pliers 12 in 1 Folding Tool MP2075CP, at least as early as Aug. 18, 1998.  
Royal International Corp., KC Pro 95120 12 in 1 Pocket Multi-Tool, at least as early as Aug. 18, 1998.  
SOG Specialty Knives Inc., "User's Guide for the Power-Lock® Compound Leverage" and photographs.  
Folding scissors with chain, on sale at least as early as 1994, photographs.  
CHESCO® Fold Up Tool Sets, At least as early as 1998.

*Primary Examiner*—Alan P. Douglas  
*Assistant Examiner*—Clare E. Heflin  
(74) *Attorney, Agent, or Firm*—Chernoff, Vilhauer, McClung & Stenzel, LLP

(57) **CLAIM**

The ornamental design for a handle for a tool, as shown and described.

**DESCRIPTION**

FIG. 1 is an isometric view from the upper right front of a handle for a tool showing my new design, wherein the broken-line depictions of rivet heads on the side of the handle and of a folding tool including a pair of similar handles and a pair of scissors blades associated therewith are included merely for illustrative purposes and form no part of the claimed design;  
FIG. 2 is a right side elevational view of the handle for a tool shown in FIG. 1, the left side elevational view thereof being a mirror image of this view;  
FIG. 3 is a top plan view thereof;  
FIG. 4 is a bottom plan view thereof;  
FIG. 5 is a rear end elevational view thereof;  
FIG. 6 is a front end elevational view thereof; and,  
FIG. 7 is an isometric view taken from the upper right front thereof.

**1 Claim, 2 Drawing Sheets**

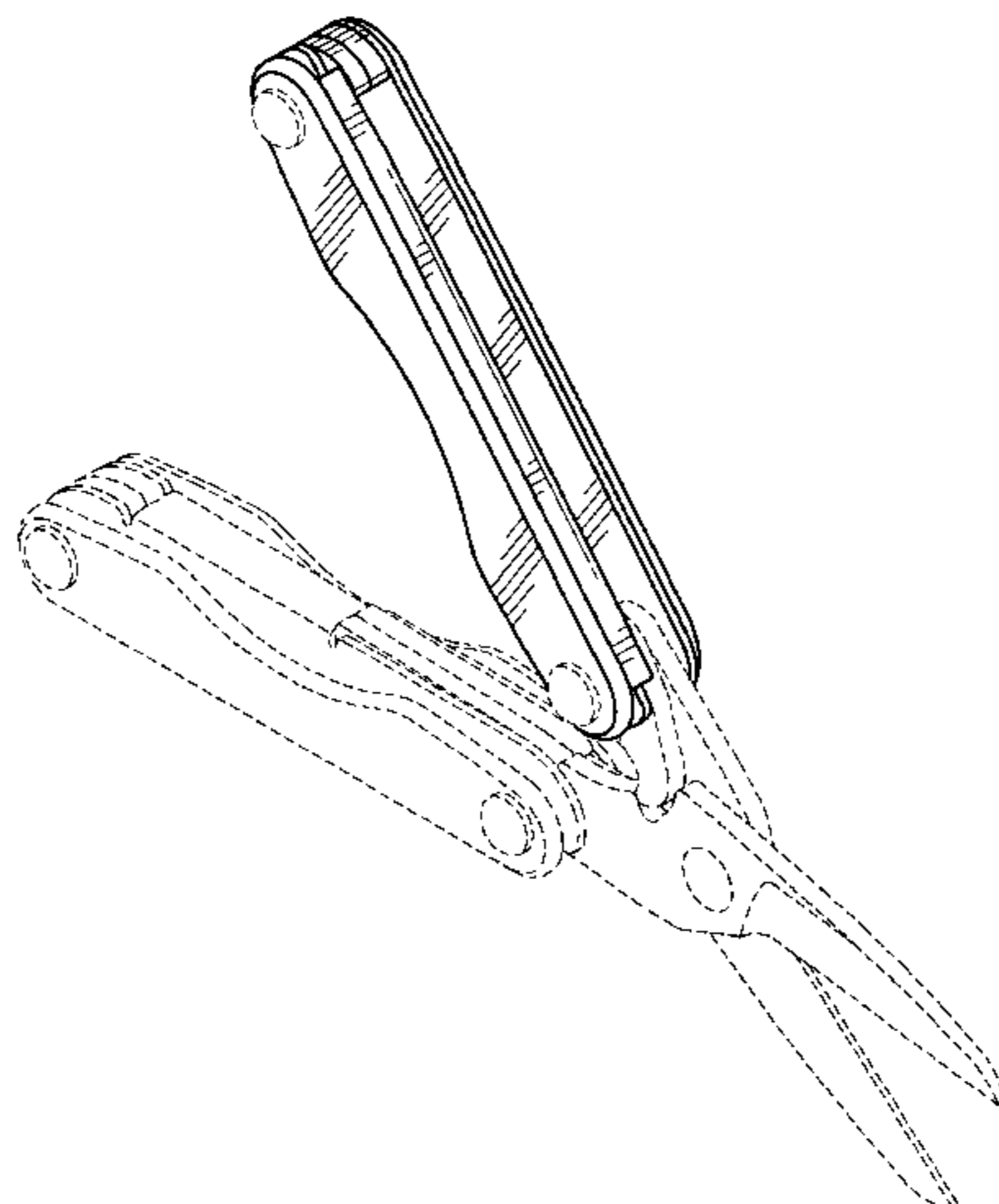

# US D470,032 S

Page 2

## U.S. PATENT DOCUMENTS

1,828,121 A	10/1931	Adam et al.		5,704,236 A	*	1/1998	Parsons	70/456 R
2,126,699 A	8/1938	Florian	30/255	D392,519 S		3/1998	Hung	D8/5
2,980,996 A	4/1961	Beran	30/157	5,722,171 A		3/1998	Schmidt	30/255
3,747,211 A	7/1973	Calabrese	30/155	5,745,997 A		5/1998	Berg et al.	30/155
4,238,862 A	12/1980	Leatherman	7/128	D398,209 S		9/1998	Rivera	D8/52
4,744,272 A	5/1988	Leatherman	81/427.5	D398,213 S		9/1998	Rivera	D8/105
D296,042 S	6/1988	Lee	D3/18	5,809,599 A		9/1998	Frazer	7/128
D303,872 S	10/1989	Tamamura	D3/18	D401,133 S		11/1998	Gardiner et al.	D8/105
4,882,841 A	* 11/1989	Margolis	7/118	5,829,329 A	*	11/1998	Frazer	81/427.5
5,029,354 A	7/1991	Boyd, Jr. et al.	7/118	D402,869 S		12/1998	Rivera	D8/57
5,062,173 A	11/1991	Collins et al.	7/118	D403,944 S		1/1999	Rivera	D8/107
5,142,721 A	9/1992	Sessions et al.	7/128	D407,622 S		4/1999	Rivera	D8/52
5,283,920 A	* 2/1994	Plummer	7/118	D414,092 S		9/1999	Chang	D8/55
D348,191 S	6/1994	Williams	D8/57	5,978,993 A		11/1999	Rivera	7/128
D364,327 S	11/1995	Graham	D8/105	D417,601 S		12/1999	Rivera	D8/107
D368,634 S	4/1996	Frazer	D8/105	6,014,787 A		1/2000	Rivera	7/128
5,526,571 A	6/1996	Lindén	30/255	D421,377 S		3/2000	Rivera	D8/58
5,537,750 A	7/1996	Seber et al.	30/161	D423,893 S		5/2000	Mackin et al.	D8/52
5,564,318 A	10/1996	Pail	81/427.5	D426,446 S		6/2000	Chau	D8/105
D380,362 S	7/1997	Rivera	D8/52	D426,447 S		6/2000	Chau	D8/105
D382,190 S	8/1997	Blackston et al.	D8/107	D427,875 S		7/2000	Chiu	D8/105
D382,455 S	8/1997	Berg	D8/52	6,092,444 A		7/2000	Hsiao	81/440
D384,872 S	10/1997	Yeh	D8/105	D429,131 S		8/2000	Rivera	D8/58
D385,168 S	10/1997	Rivera	D8/52	D429,132 S		8/2000	Rivera	D8/58
D385,169 S	10/1997	Rivera	D8/52	D429,616 S		8/2000	Rivera	D8/105
D385,170 S	10/1997	Rivera	D8/52	D433,902 S		11/2000	Rivera	D8/52
D385,172 S	10/1997	Bramsiepe et al.	D8/83	D445,009 S	*	7/2001	Rivera	D8/52

\* cited by examiner

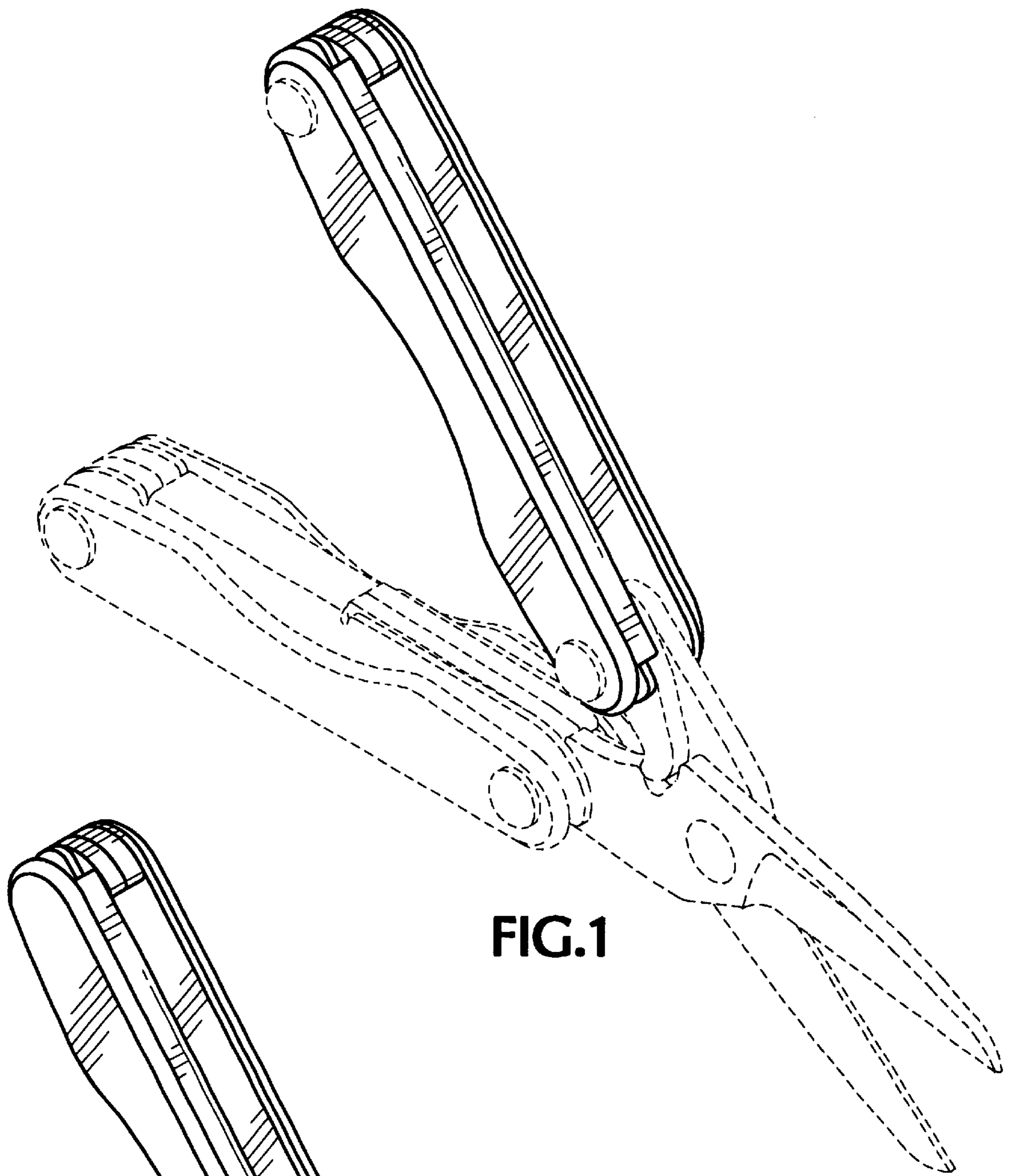

FIG.1

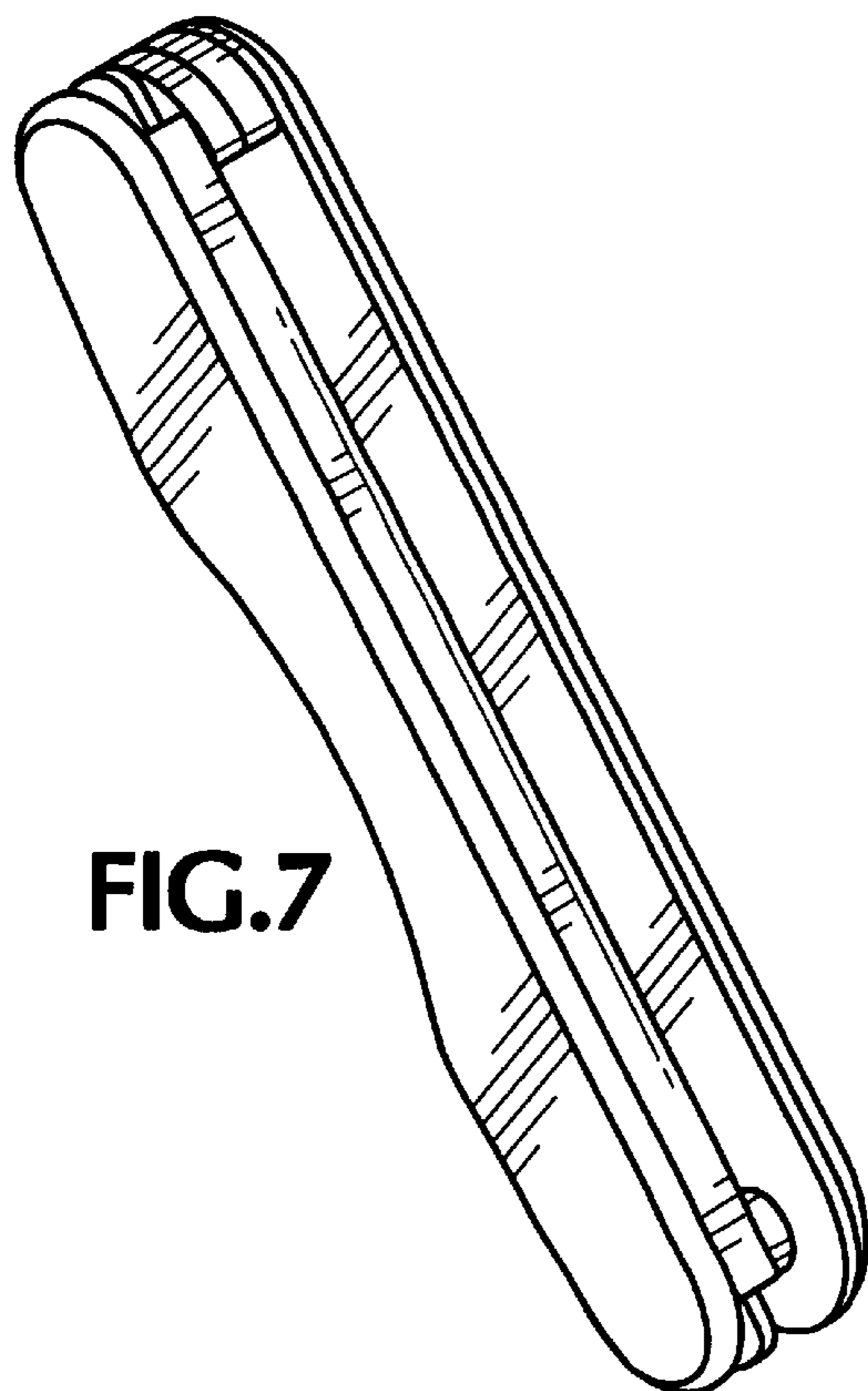

FIG.7

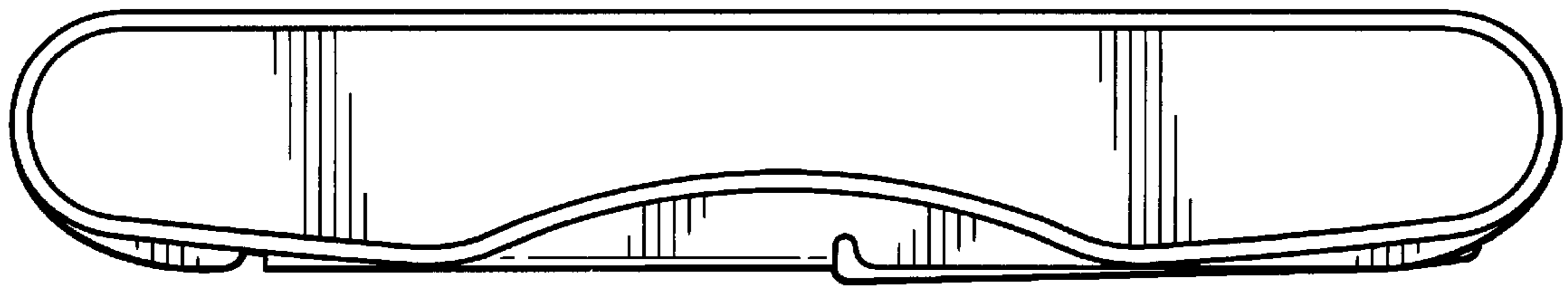

FIG. 2

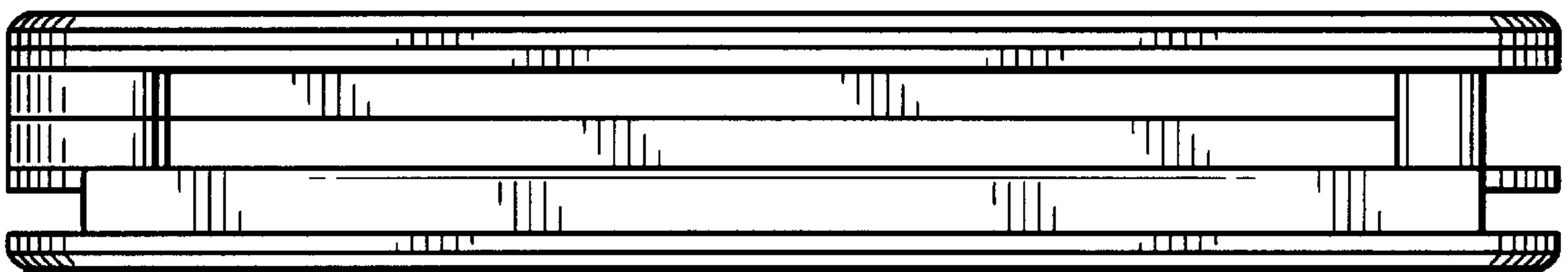

FIG. 3

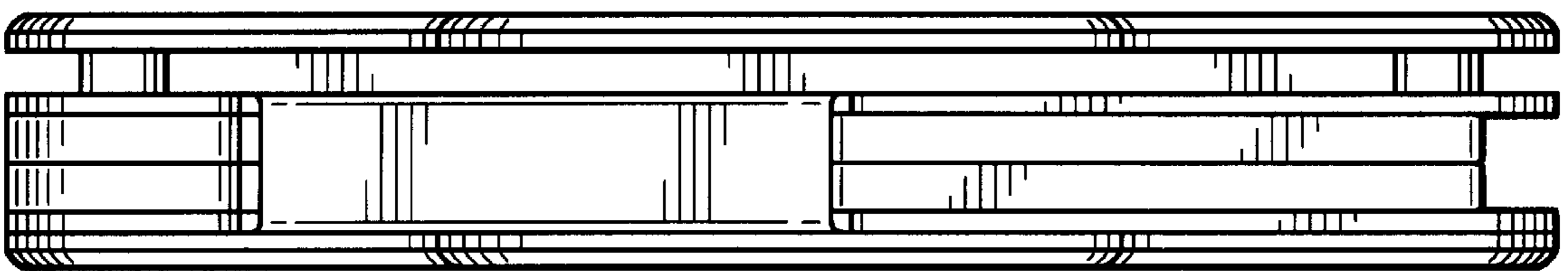

FIG. 4

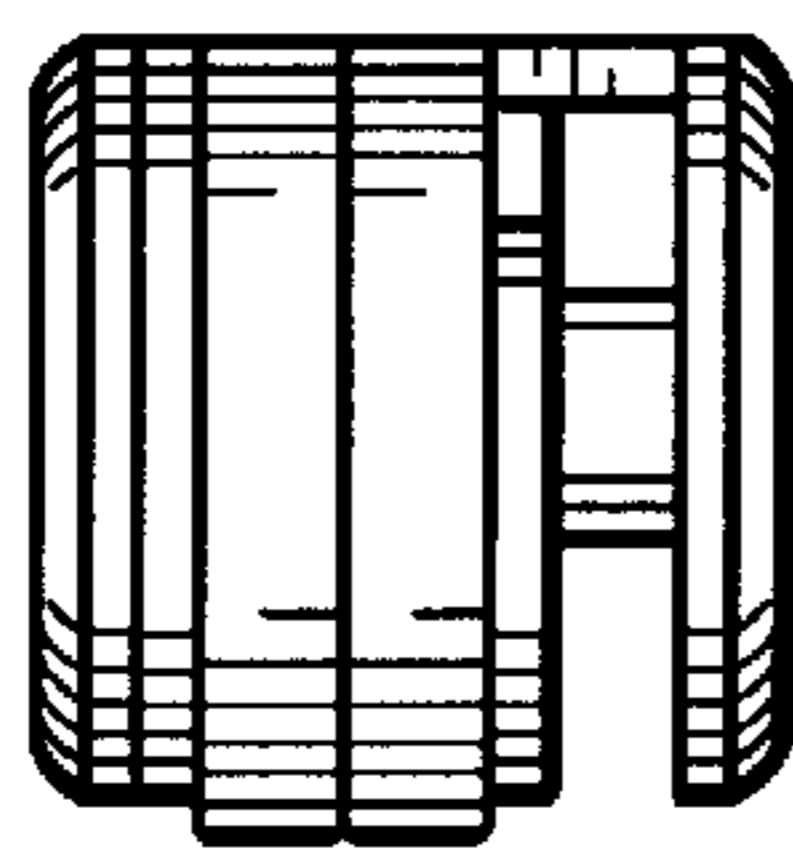

FIG. 5

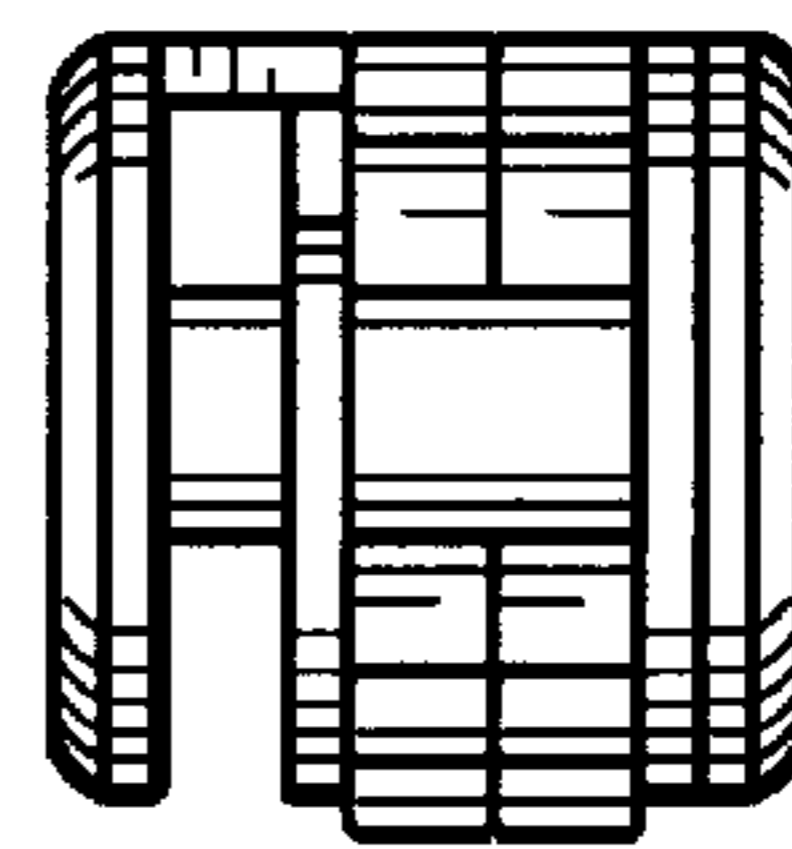

FIG. 6