



US00D470029S

(12) **United States Design Patent**
Wolff

(10) **Patent No.:** **US D470,029 S**

(45) **Date of Patent:** **** Feb. 11, 2003**

(54) **RATCHET CLAMP**

DESCRIPTION

(75) Inventor: **Friedrich Wolff**, Bad Neuenahr (DE)

(73) Assignee: **Wolcraft GmbH**, Kempenich (DE)

(**) Term: **14 Years**

(21) Appl. No.: **29/146,414**

(22) Filed: **Aug. 9, 2001**

(30) **Foreign Application Priority Data**

Feb. 10, 2001 (DE) 4 01 01 560

(51) **LOC (7) Cl.** **08-05**

(52) **U.S. Cl.** **D8/72**

(58) **Field of Search** D8/71-74; 81/300,
81/302, 318, 319, 323-325, 338, 392, 418,
421, 424, 314, 411, 415; 269/6, 96, 97,
157, 163, 229, 254 CS, 257-259, 902

(56) **References Cited**

U.S. PATENT DOCUMENTS

3,456,262	A	*	7/1969	Coon	24/501
3,779,108	A	*	12/1973	Reiter	81/424
D350,892	S	*	9/1994	Sorensen	D8/72
D399,729	S	*	10/1998	Chen	D8/72
6,000,686	A	*	12/1999	Yates	269/6
6,240,815	B1	*	6/2001	Huang	269/6
6,336,386	B1	*	1/2002	Lee	81/314
D457,409	S	*	5/2002	Noniewicz	D8/72

* cited by examiner

Primary Examiner—Louis S. Zarfaz

Assistant Examiner—Deanne Levy

(74) *Attorney, Agent, or Firm*—Schiff Hardin & Waite

(57) **CLAIM**

The ornamental design for a ratchet clamp, as shown and described.

FIG. 1 is a perspective view of a ratchet clamp in an open position;

FIG. 2 is an elevational view of the left side of the ratchet clamp of FIG. 1 with the right side being a mirror image;

FIG. 3 is an end view of the opened jaws of the ratchet clamp of FIG. 1;

FIG. 4 is a bottom plan view of the ratchet clamp of FIG. 1;

FIG. 5 is an elevational view of the left side of the ratchet clamp of FIG. 1 in a closed position;

FIG. 6 is a perspective view of a second embodiment of a ratchet clamp of the present invention in an open position;

FIG. 7 is an elevational view of the left side of the ratchet clamp of FIG. 6 with the right side being a mirror image;

FIG. 8 is an end view of the open jaws of the ratchet clamp of FIG. 6;

FIG. 9 is a top plan view of the ratchet clamp of FIG. 6 with the bottom being a mirror image;

FIG. 10 is an elevational view of the left side of the ratchet clamp of FIG. 6 in a closed position;

FIG. 11 is a perspective view of a third embodiment of the ratchet clamp in an open position in accordance with the present invention;

FIG. 12 is an elevational view of the left side of the ratchet clamp of FIG. 11 with the right side being a mirror image;

FIG. 13 is an end view of the open jaws of the ratchet clamp of FIG. 11;

FIG. 14 is a plan view of the top of the ratchet clamp of FIG. 11 with the bottom view being a mirror image; and,

FIG. 15 is an elevational view of the left side of the ratchet clamp of FIG. 11 in a closed position.

1 Claim, 3 Drawing Sheets

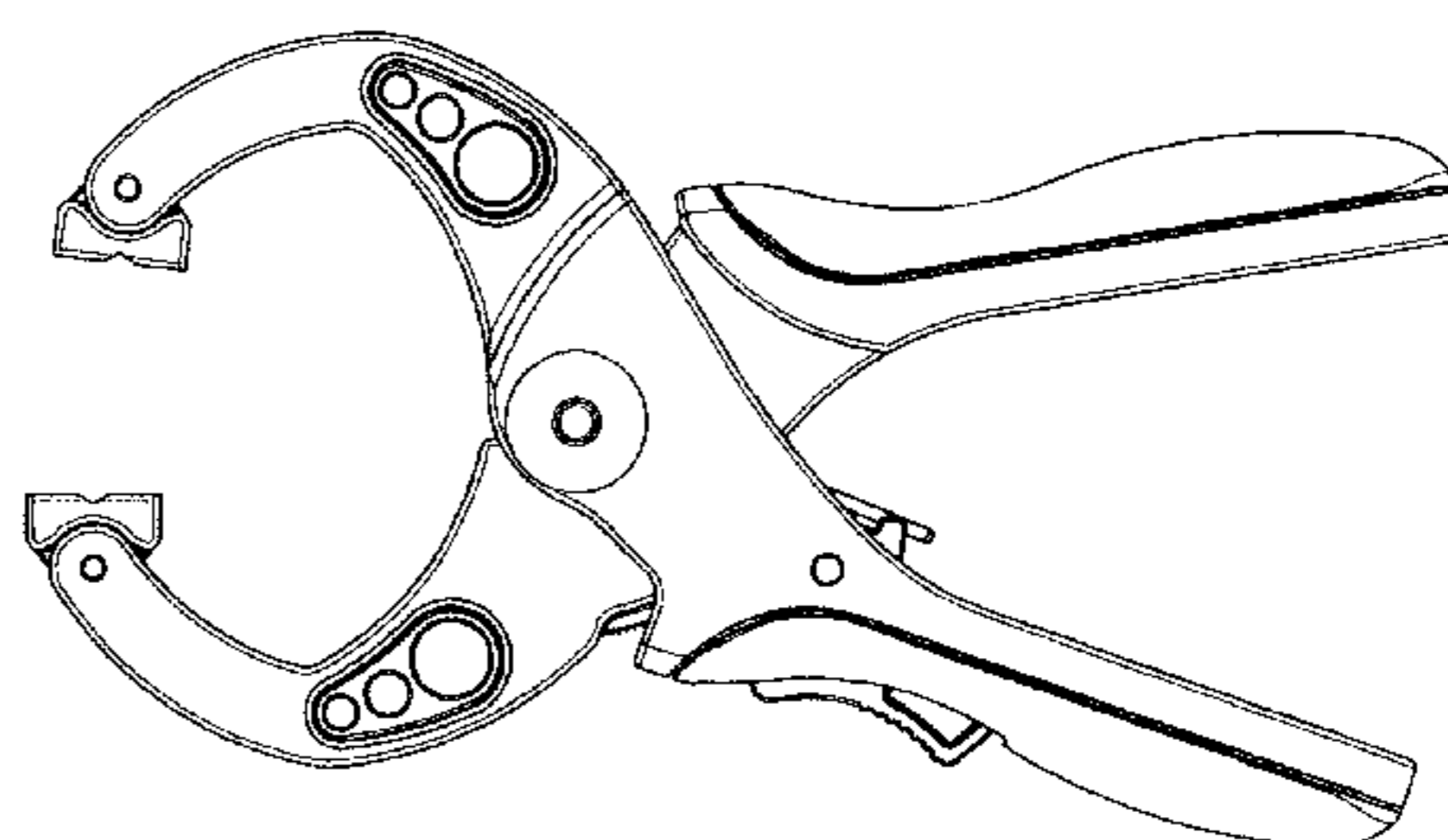
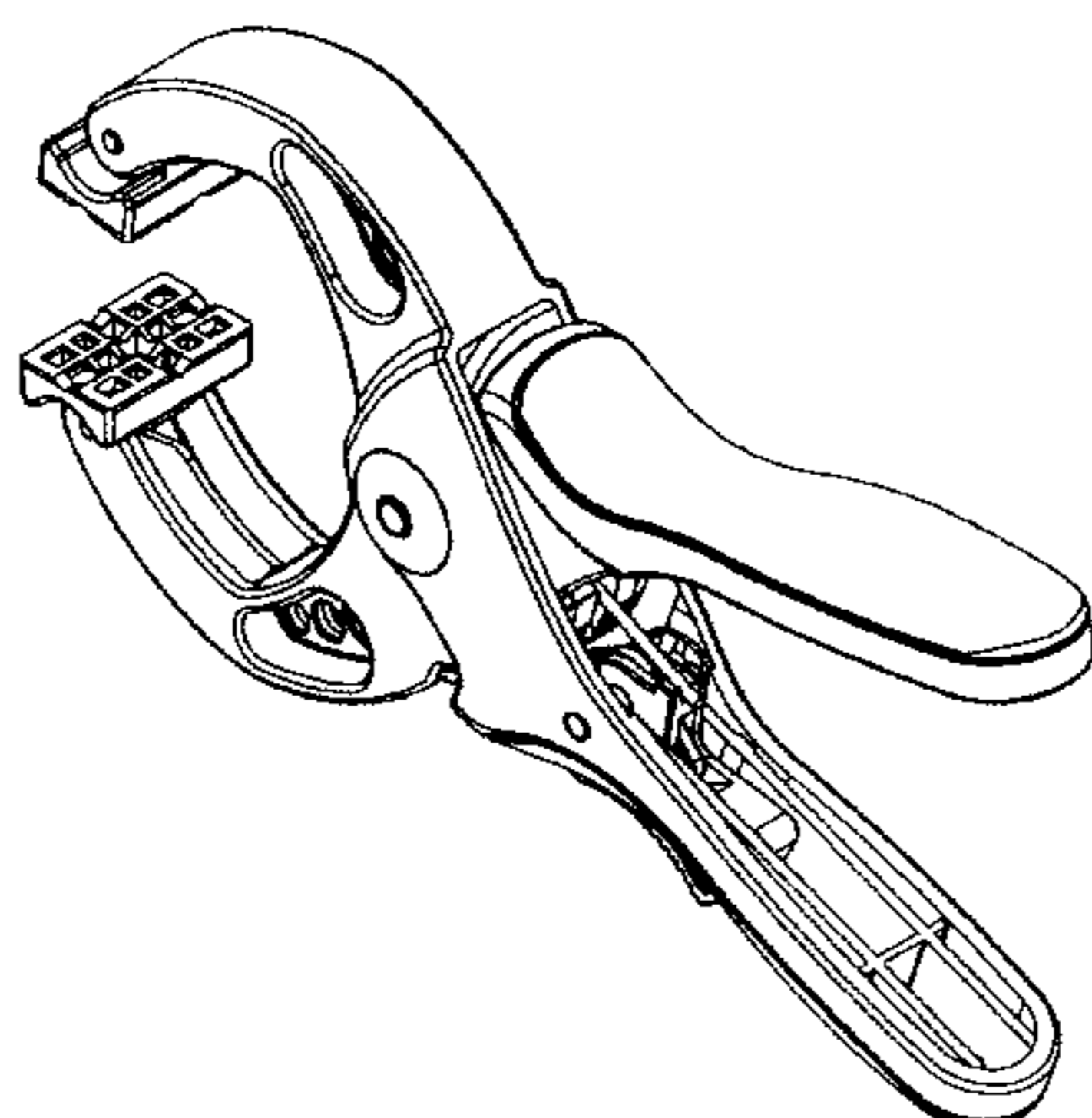

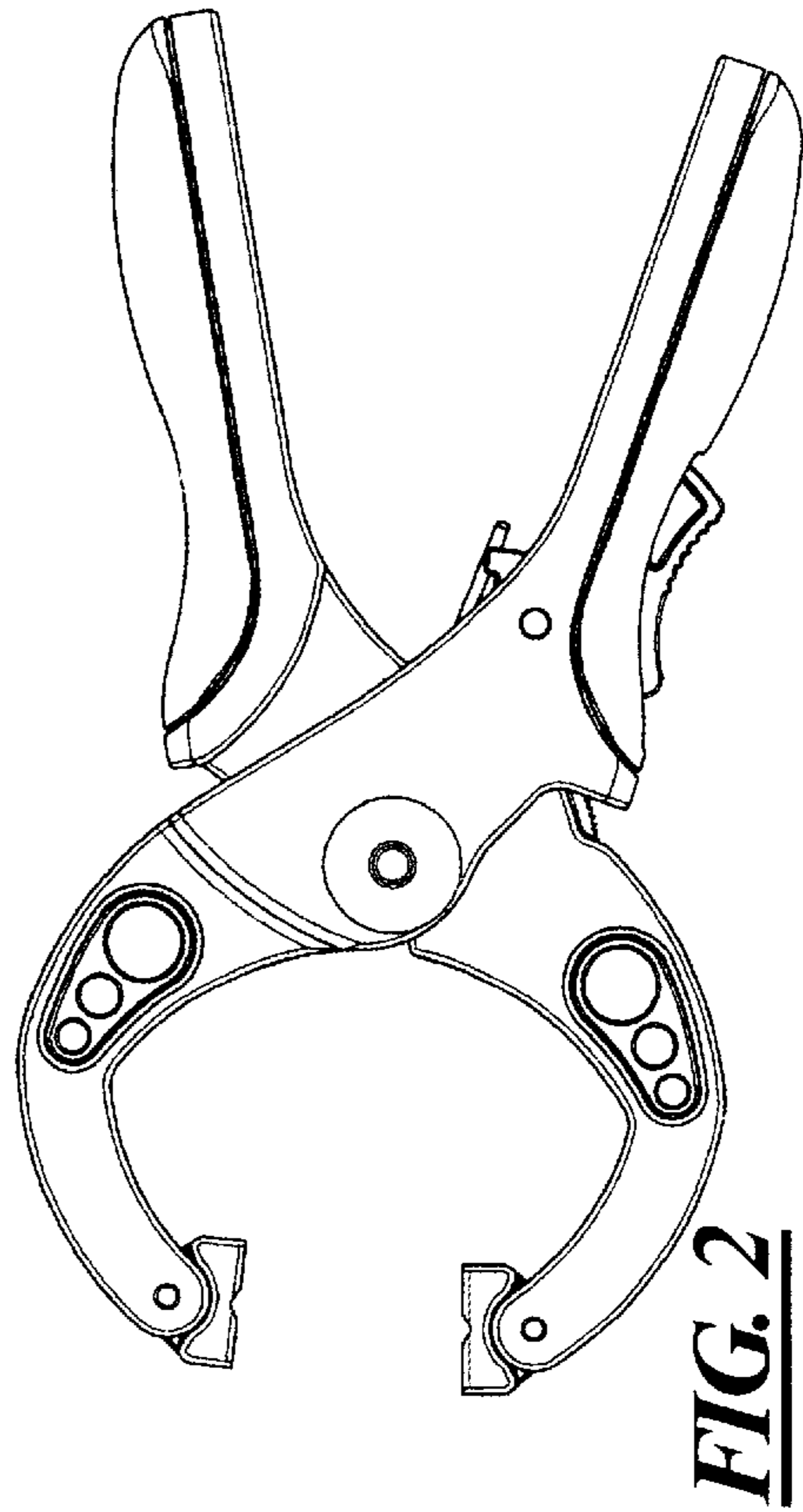
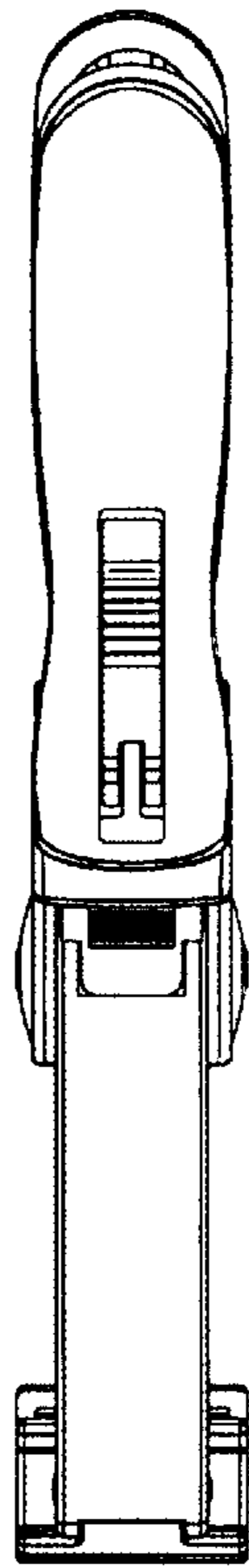
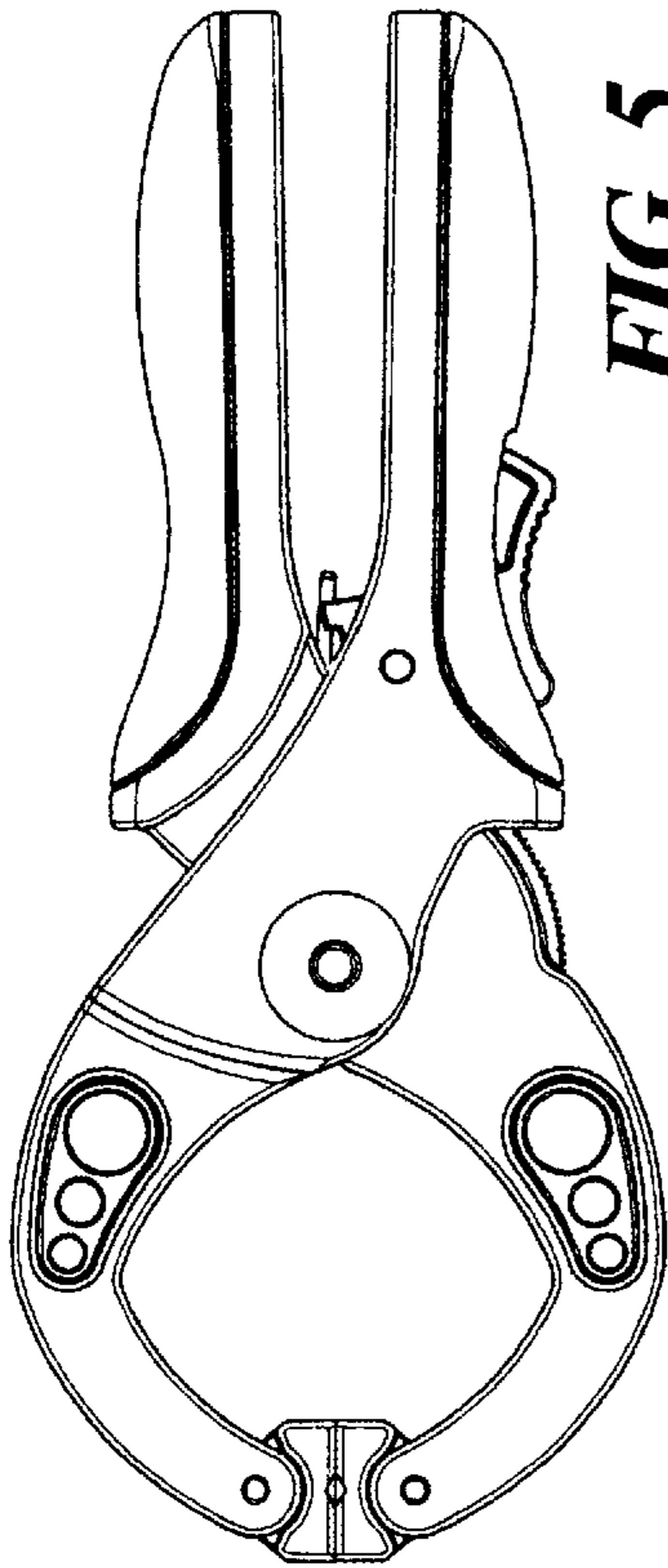
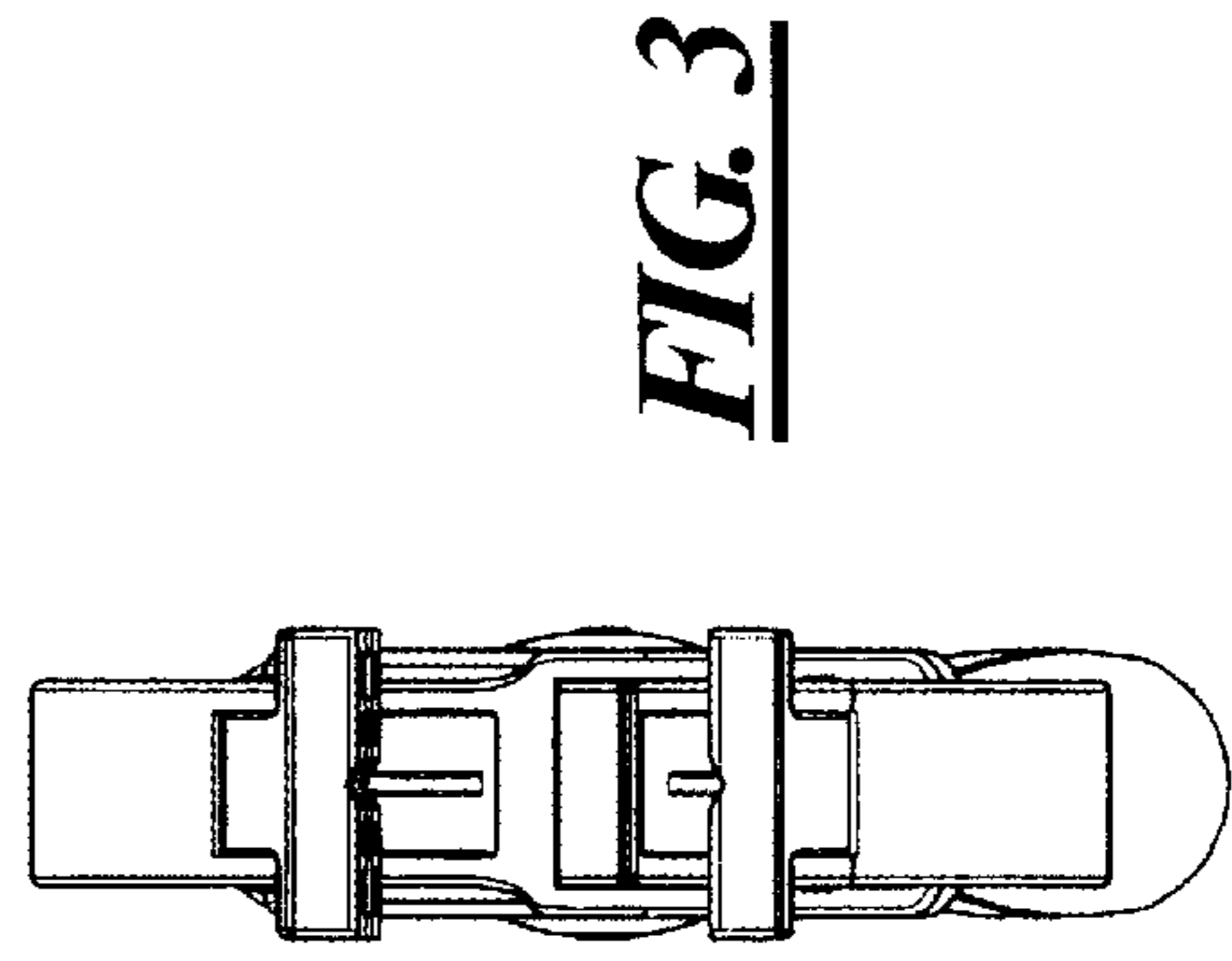
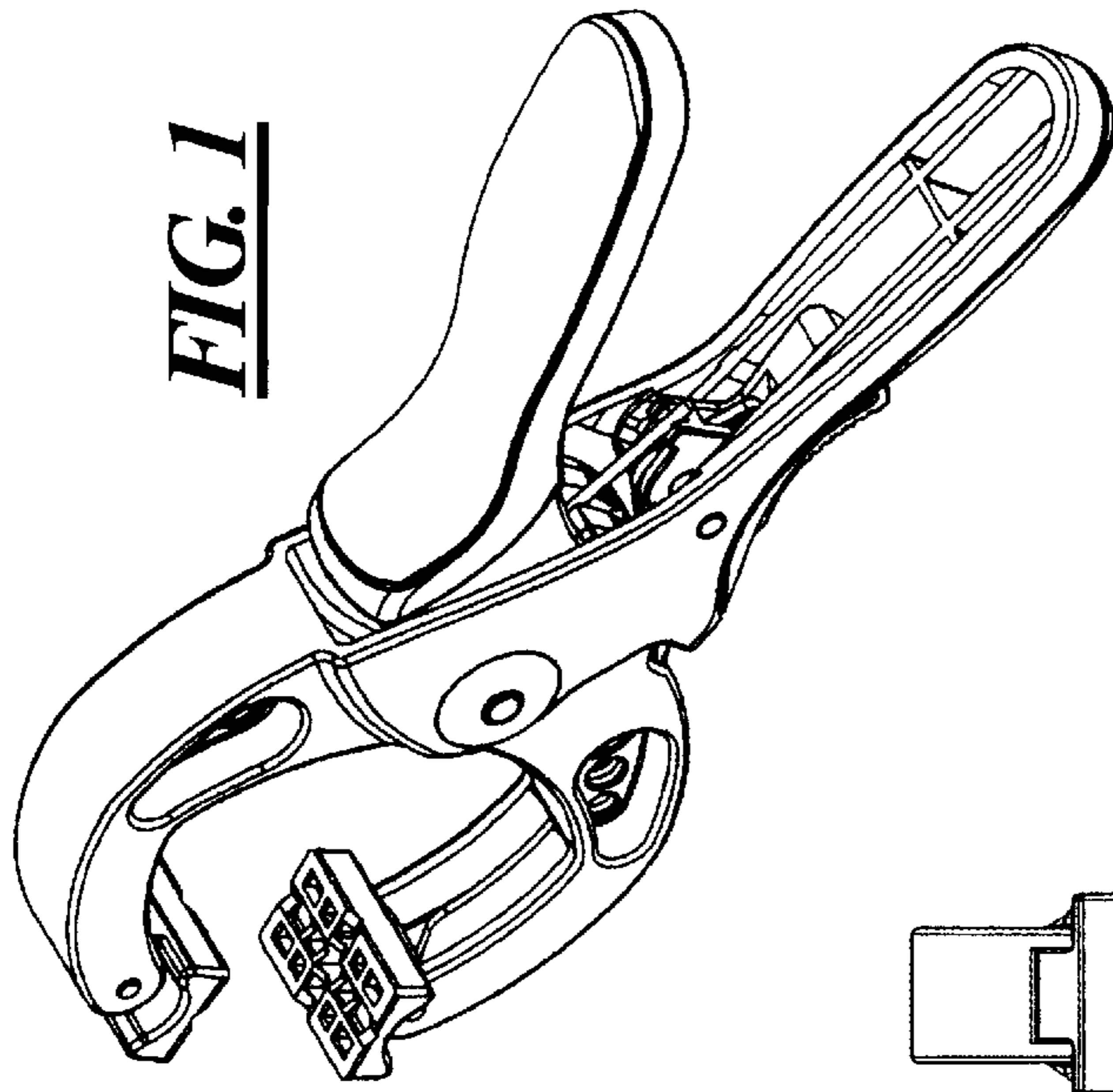

FIG. 6

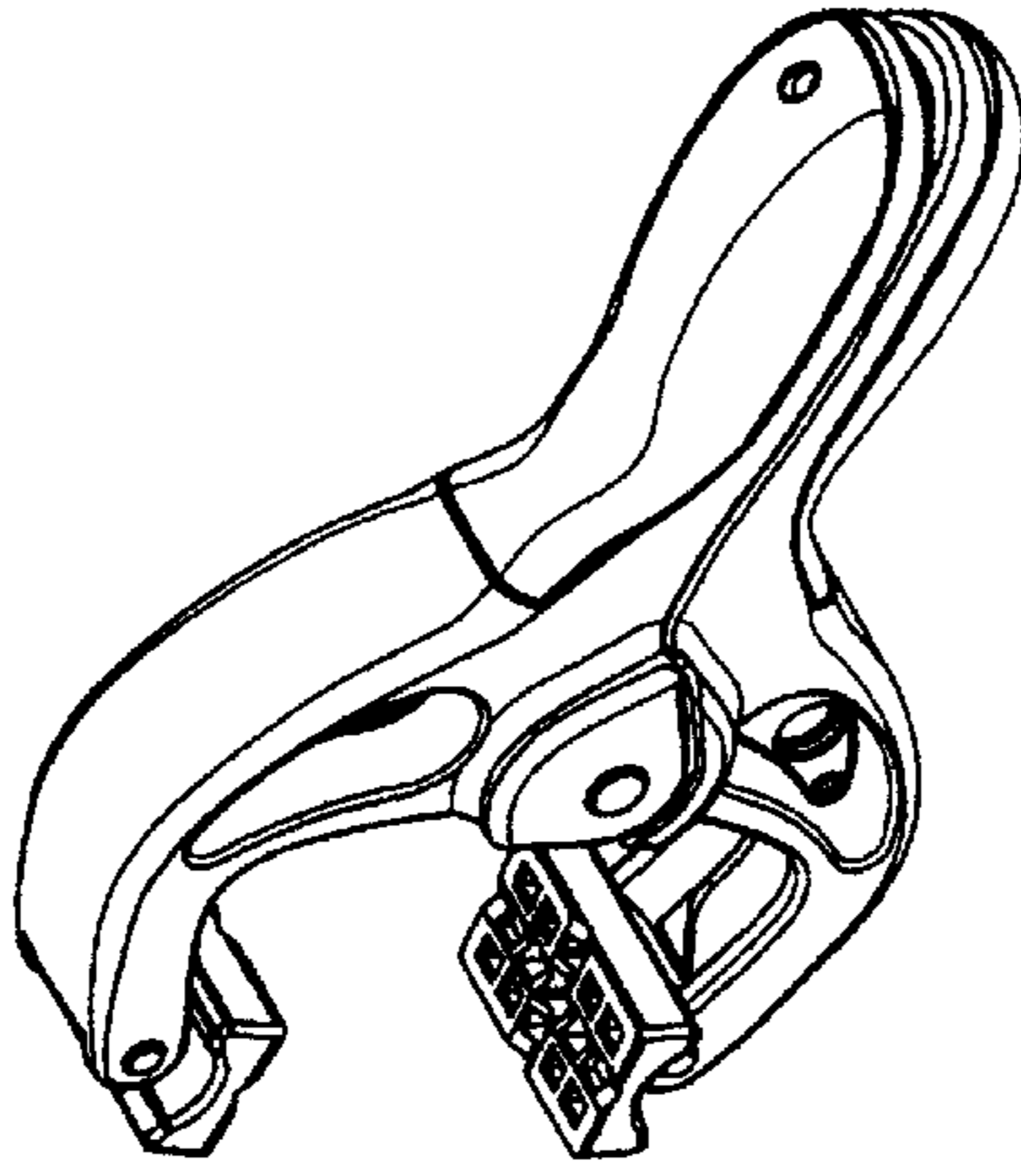

FIG. 8

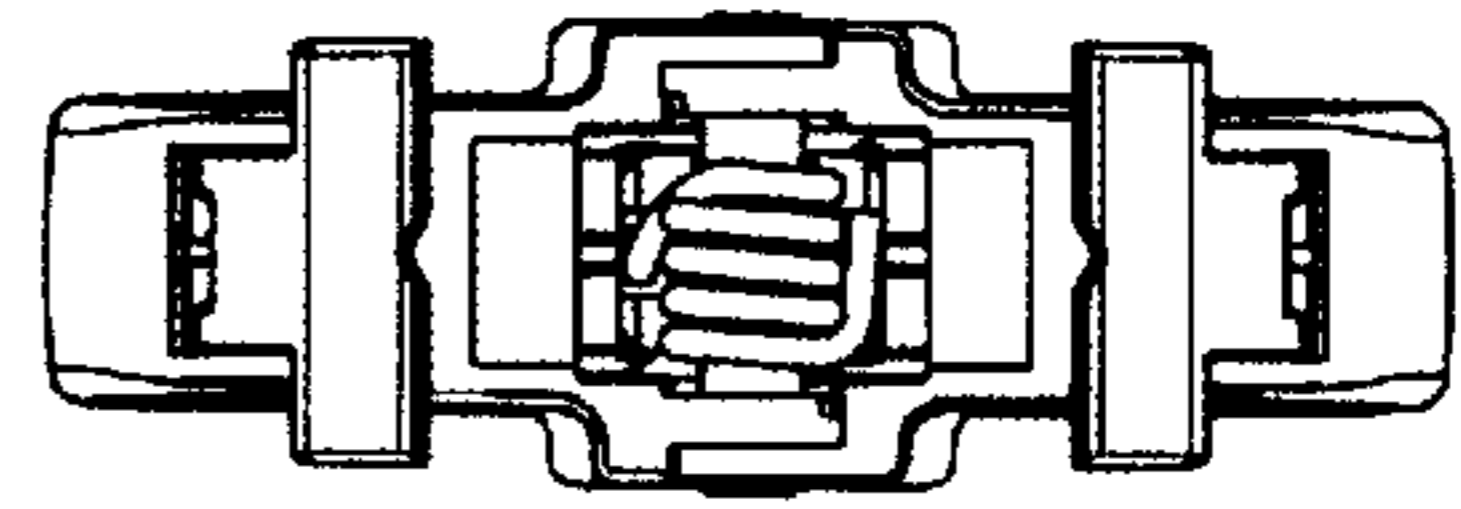

FIG. 10

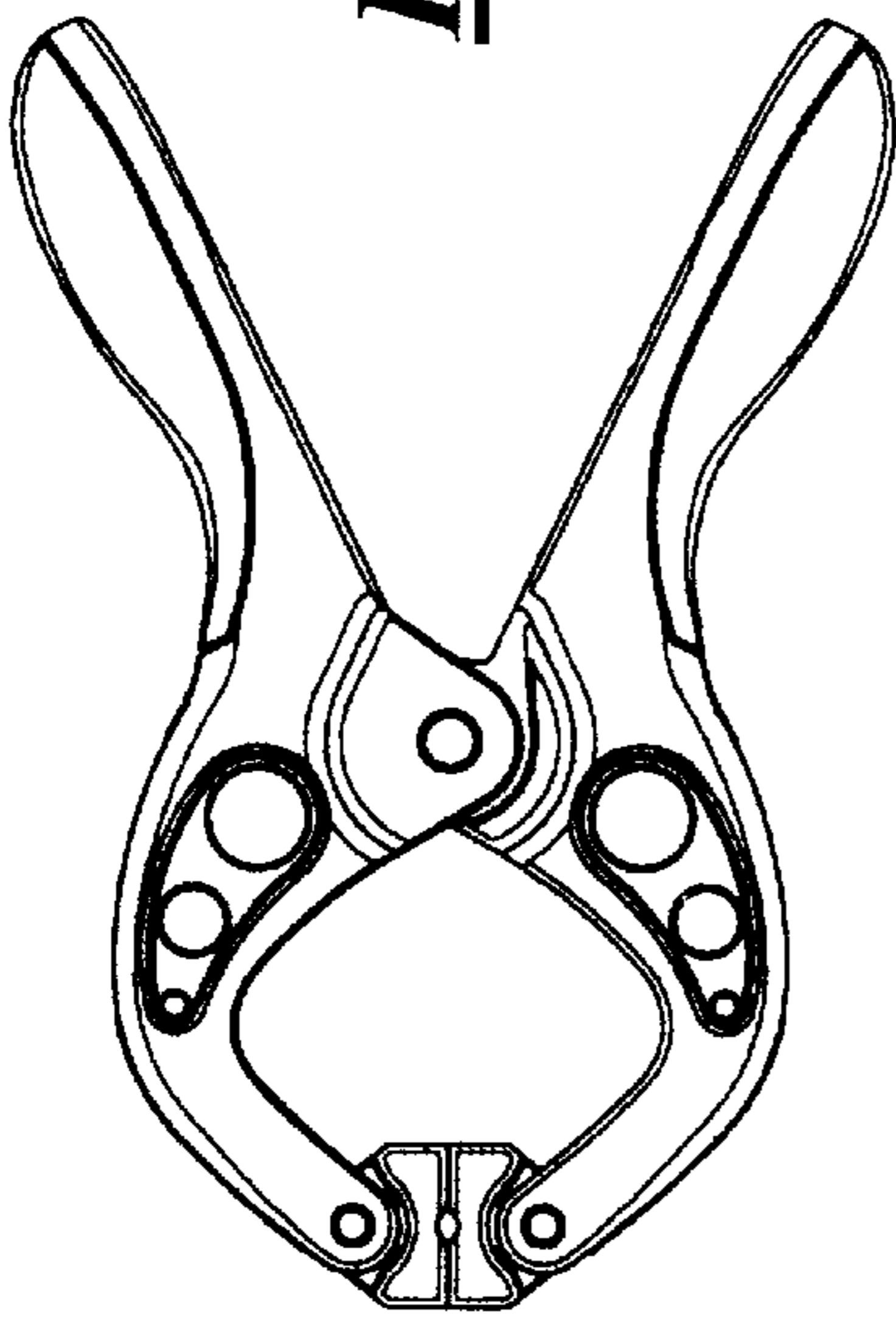

FIG. 9

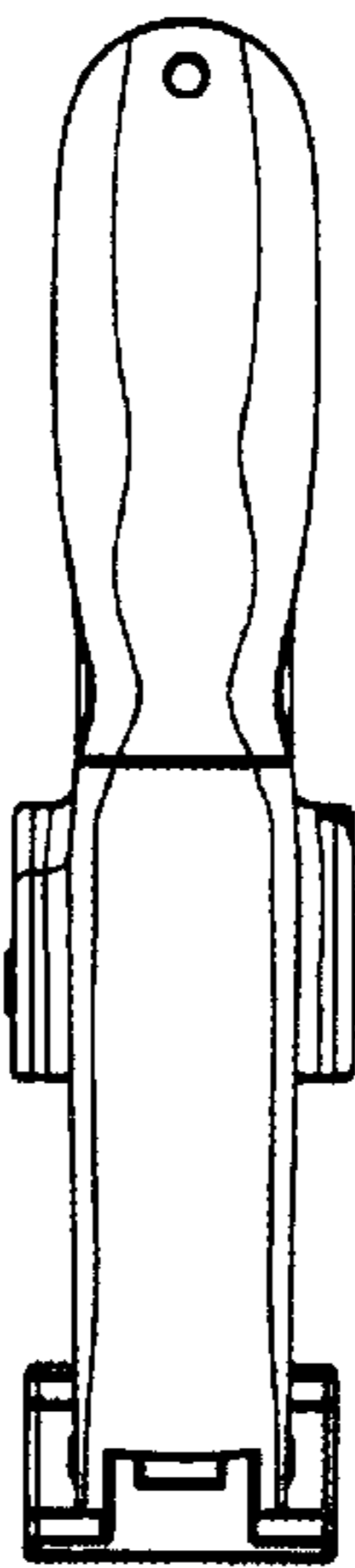
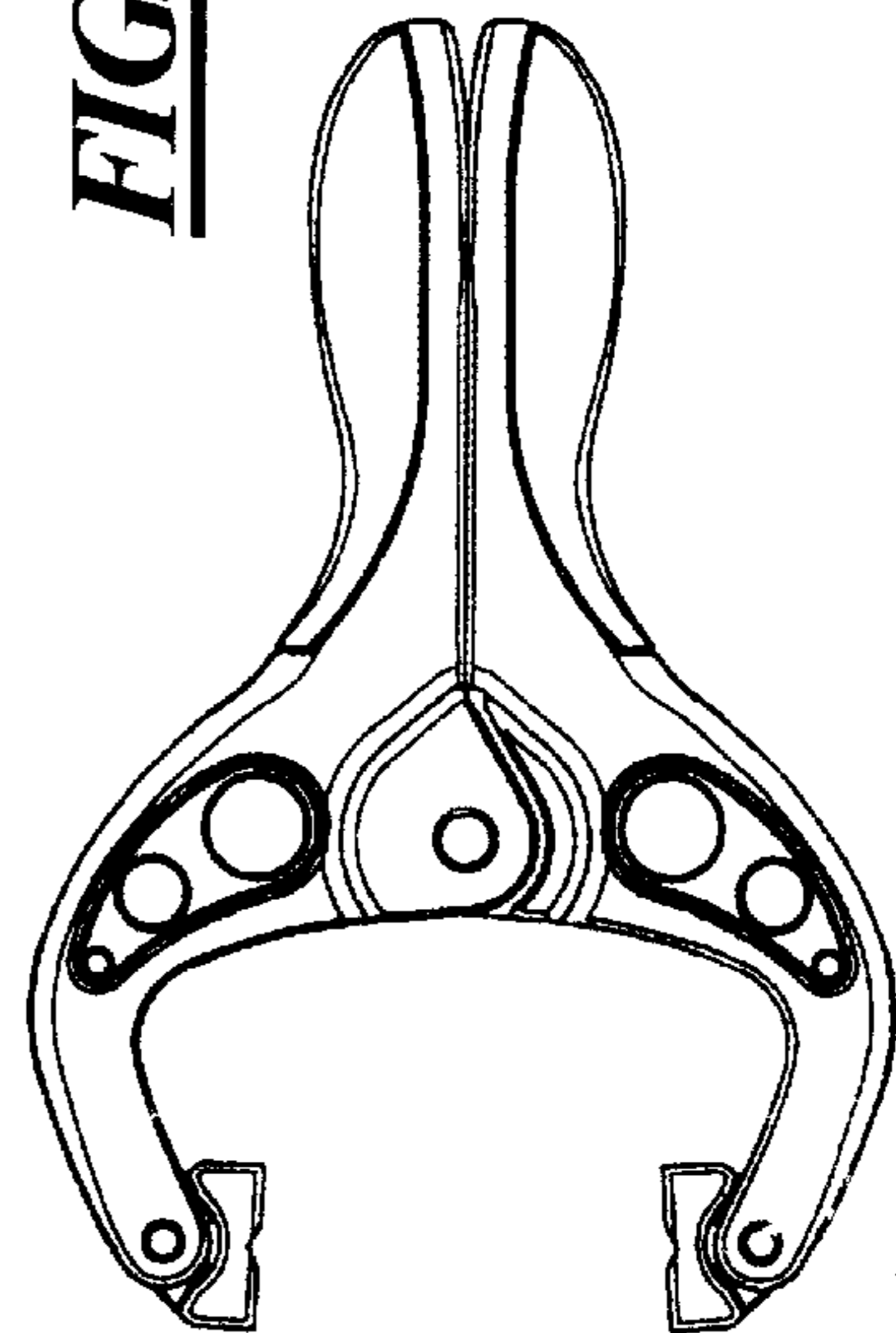

FIG. 7



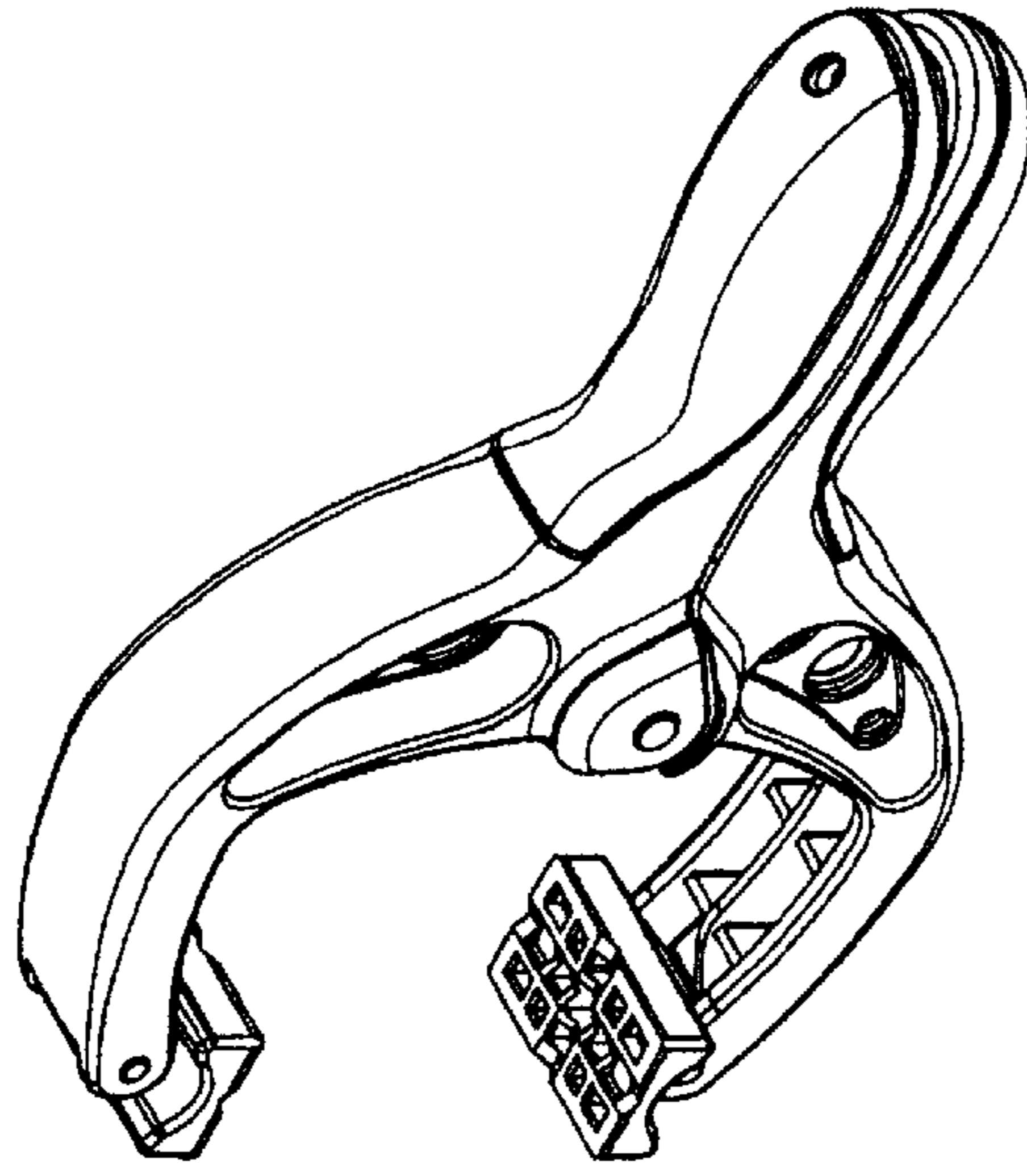

FIG. 11

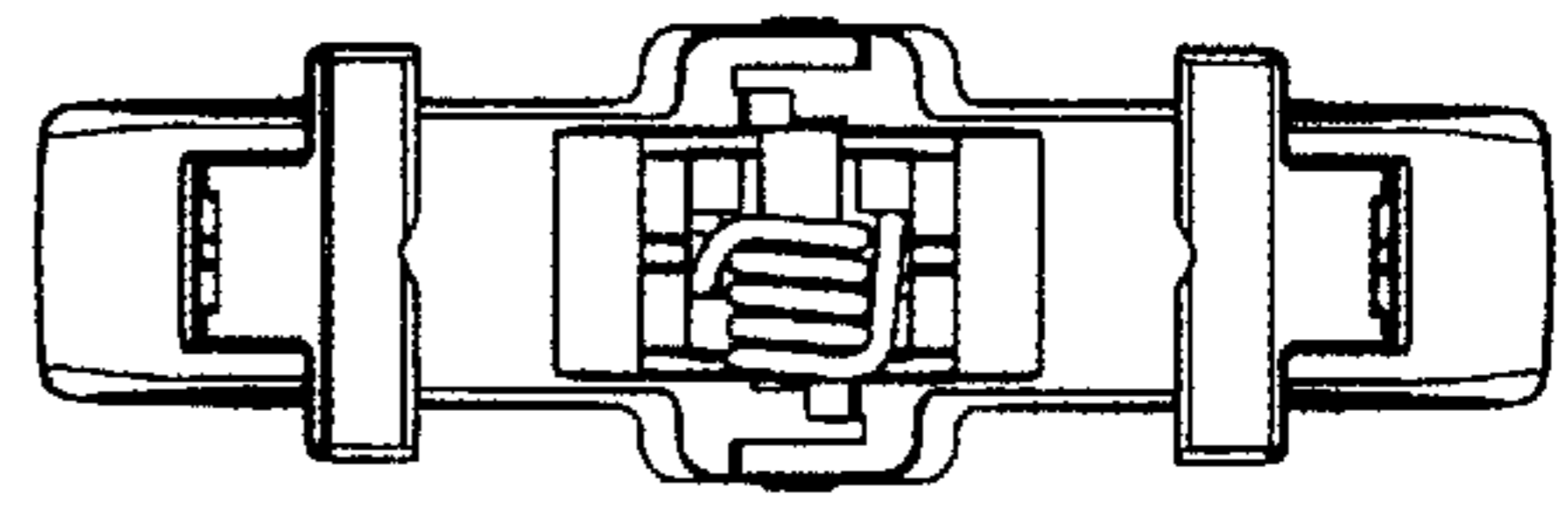

FIG. 13

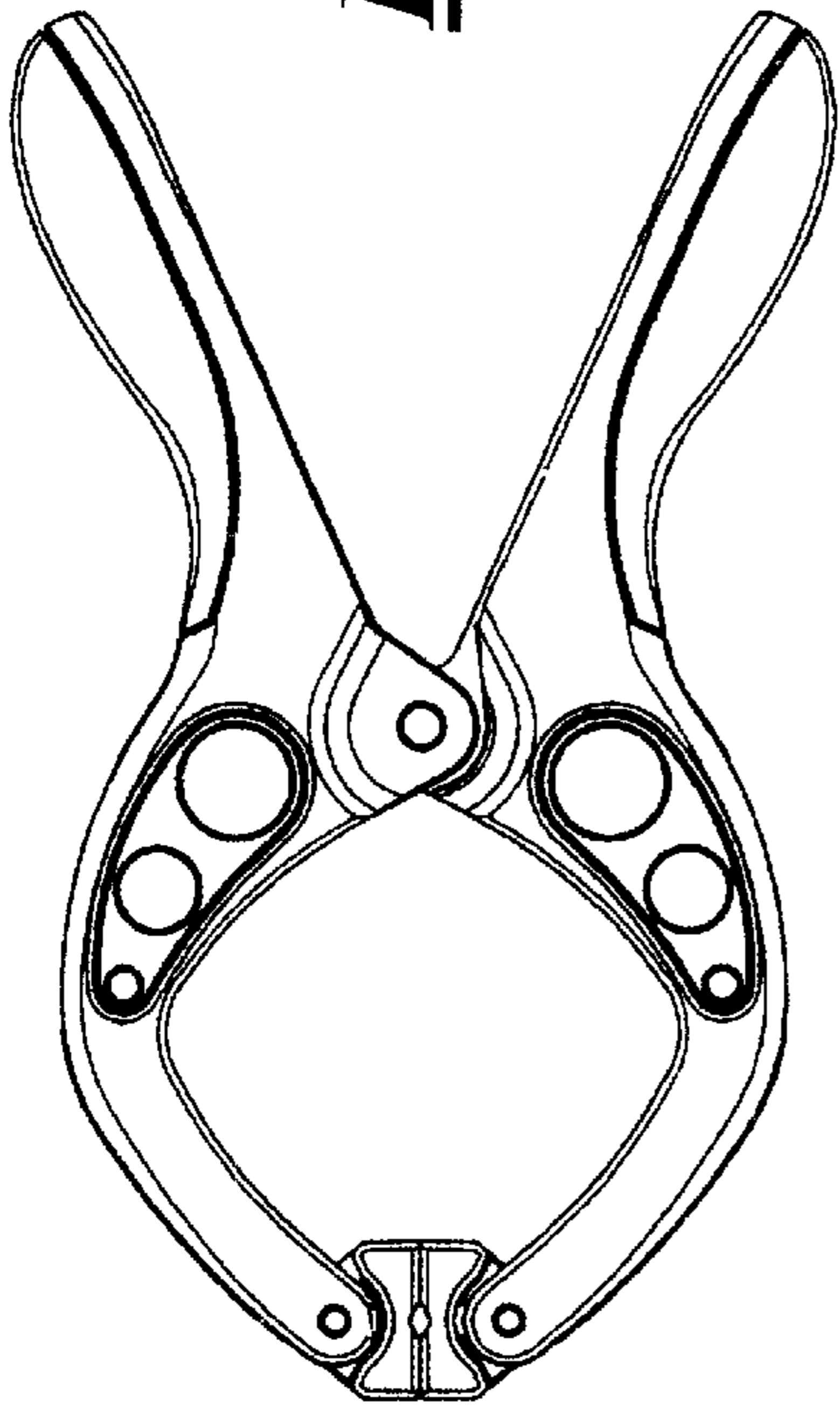

FIG. 15

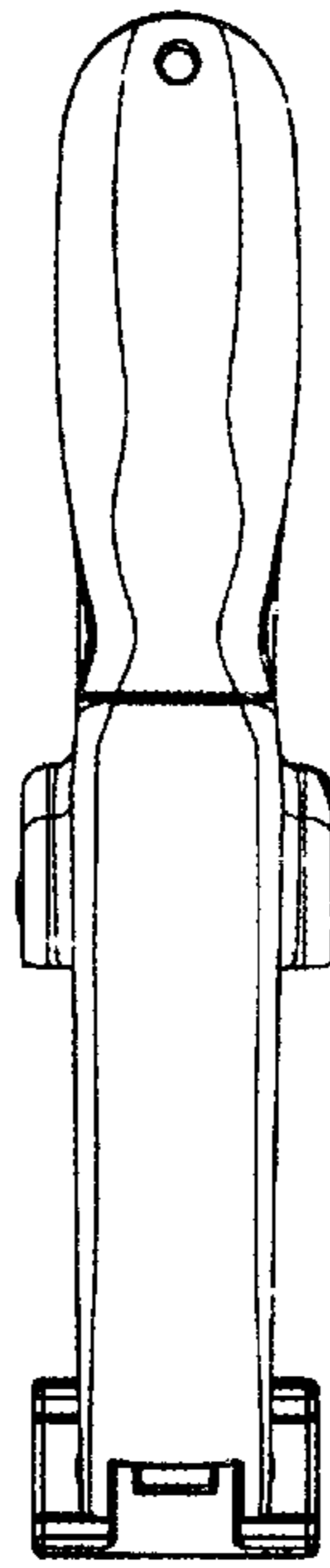

FIG. 14

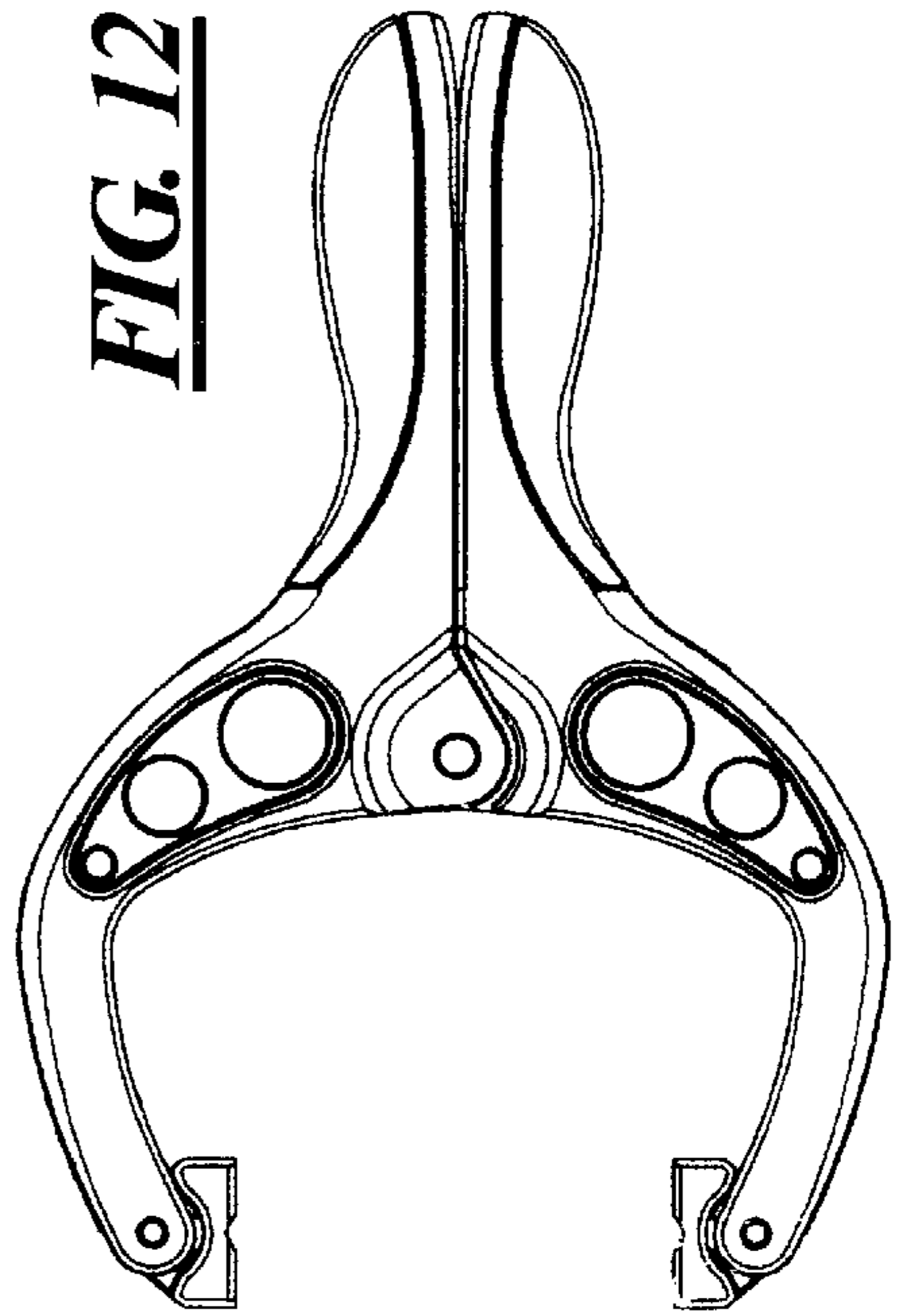

FIG. 12