



US00D470001S

(12) **United States Design Patent**  
**Munroe, II**

(10) **Patent No.:** **US D470,001 S**

(45) **Date of Patent:** **\*\* Feb. 11, 2003**

(54) **CD HOLDER**

D440,809 S \* 4/2001 Hunt ..... D6/629  
D445,287 S \* 7/2001 Kujala ..... D6/629

(76) Inventor: **H. Alexander Munroe, II**, #7 Scotch  
Bonnet La. P.O. Box 3132, Bald Head  
Island, NC (US) 28461

\* cited by examiner

(\*\*) Term: **14 Years**

*Primary Examiner*—Cathron C. Brooks

(74) *Attorney, Agent, or Firm*—MacCord Mason PLLC

(21) Appl. No.: **29/163,014**

(22) Filed: **Jun. 25, 2002**

(57) **CLAIM**

The ornamental design for a CD holder, as shown and described.

(51) **LOC (7) Cl.** ..... **06-04**

(52) **U.S. Cl.** ..... **D6/629**

(58) **Field of Search** ..... D6/407, 628–630,  
D6/467–469, 450, 453, 462, 465, 466;  
206/307, 307.1, 308.1; 211/40, 41.1, 41.2,  
41.12; 312/9.1, 9.9, 9.47, 9.48, 9.51–9.56,  
9.64

**DESCRIPTION**

FIG. 1 is a perspective view of the CD holder.  
FIG. 2 is a left side view of the CD holder.  
FIG. 3 is a right side view of the CD holder.  
FIG. 4 is a front view of the CD holder.  
FIG. 5 is a back view of the CD holder.  
FIG. 6 is a top view of the CD holder; and,  
FIG. 7 is a bottom view of the CD holder.

(56) **References Cited**

**U.S. PATENT DOCUMENTS**

D433,251 S \* 11/2000 Blazeovich ..... D6/467

**1 Claim, 7 Drawing Sheets**

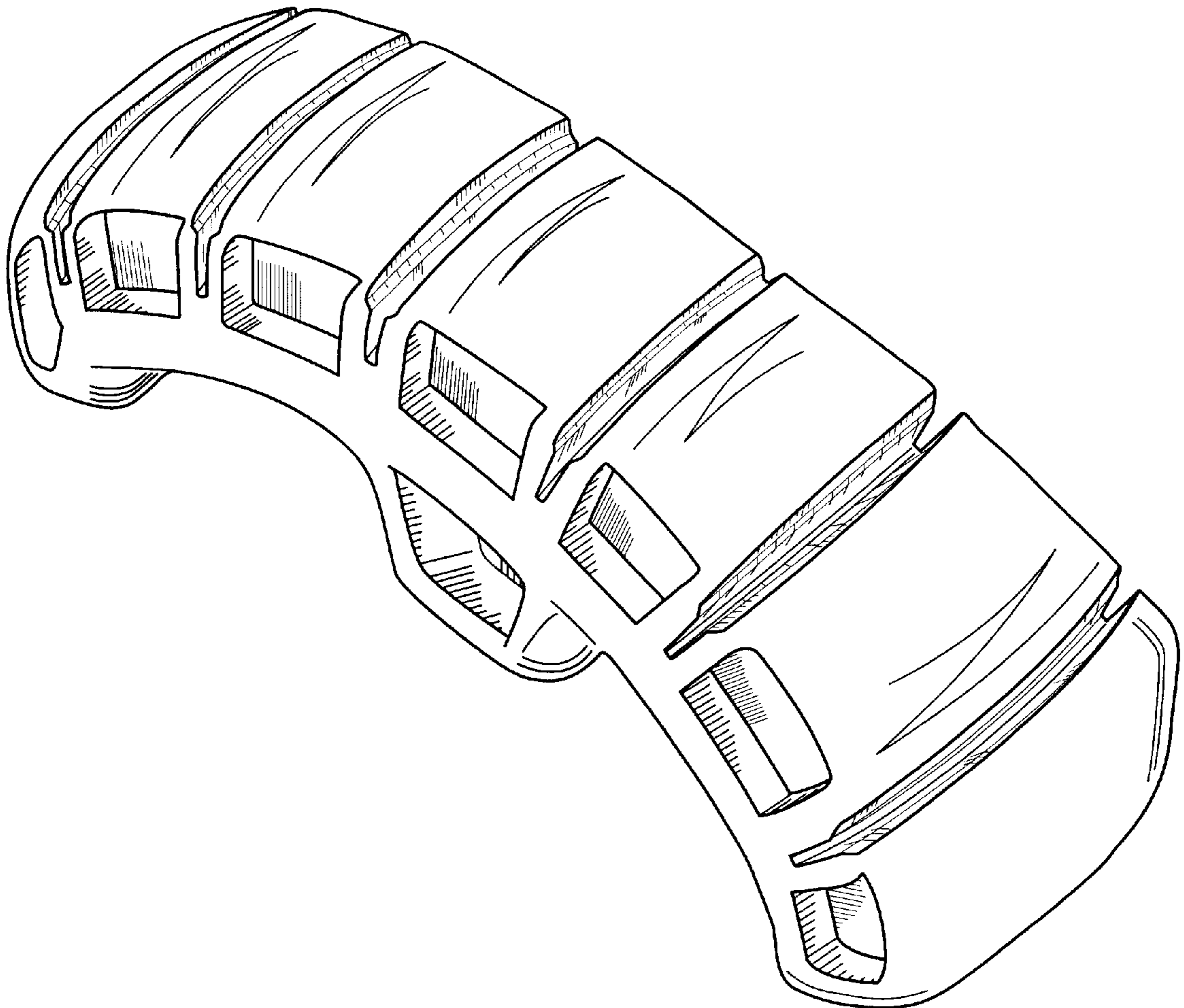

Figure 1

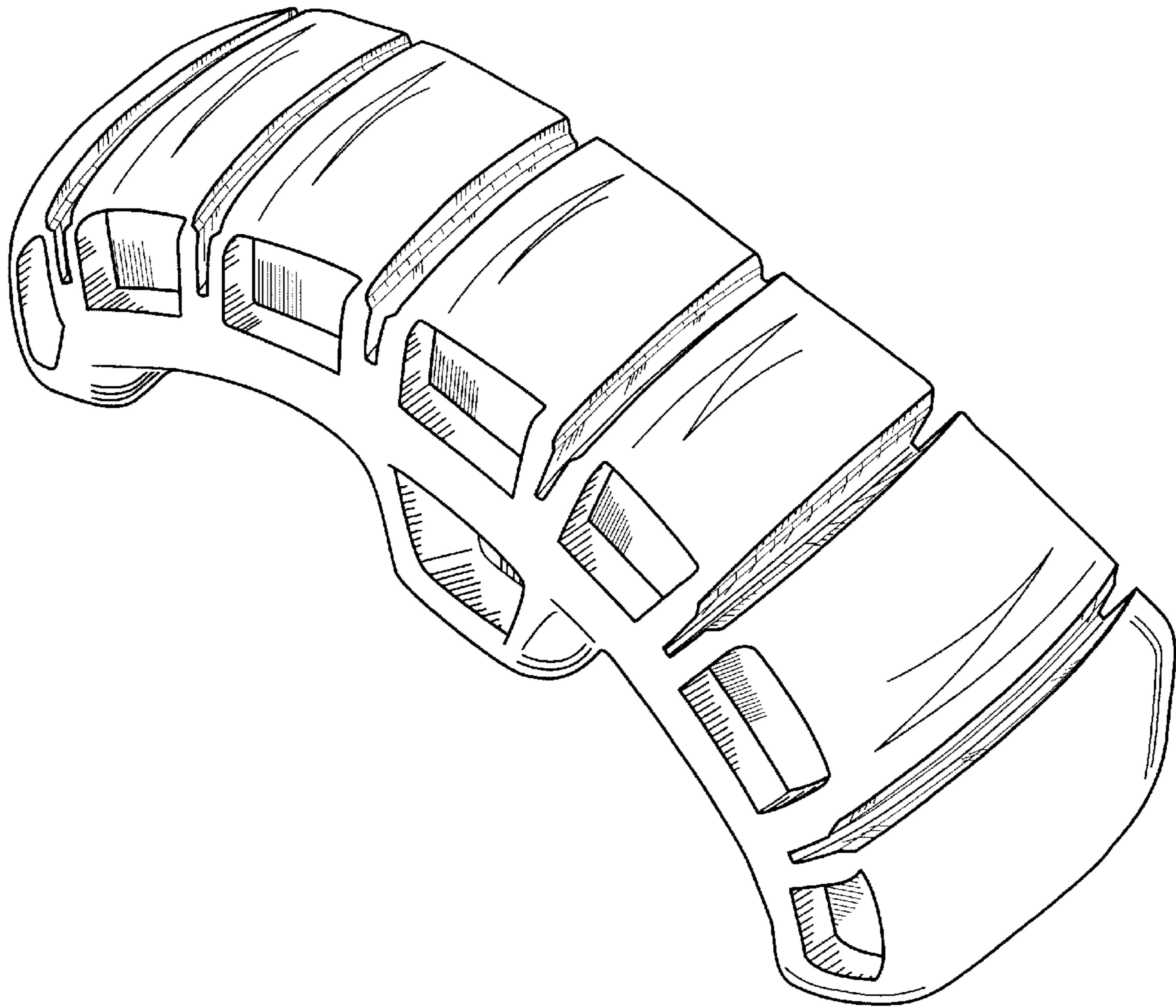

Figure 2

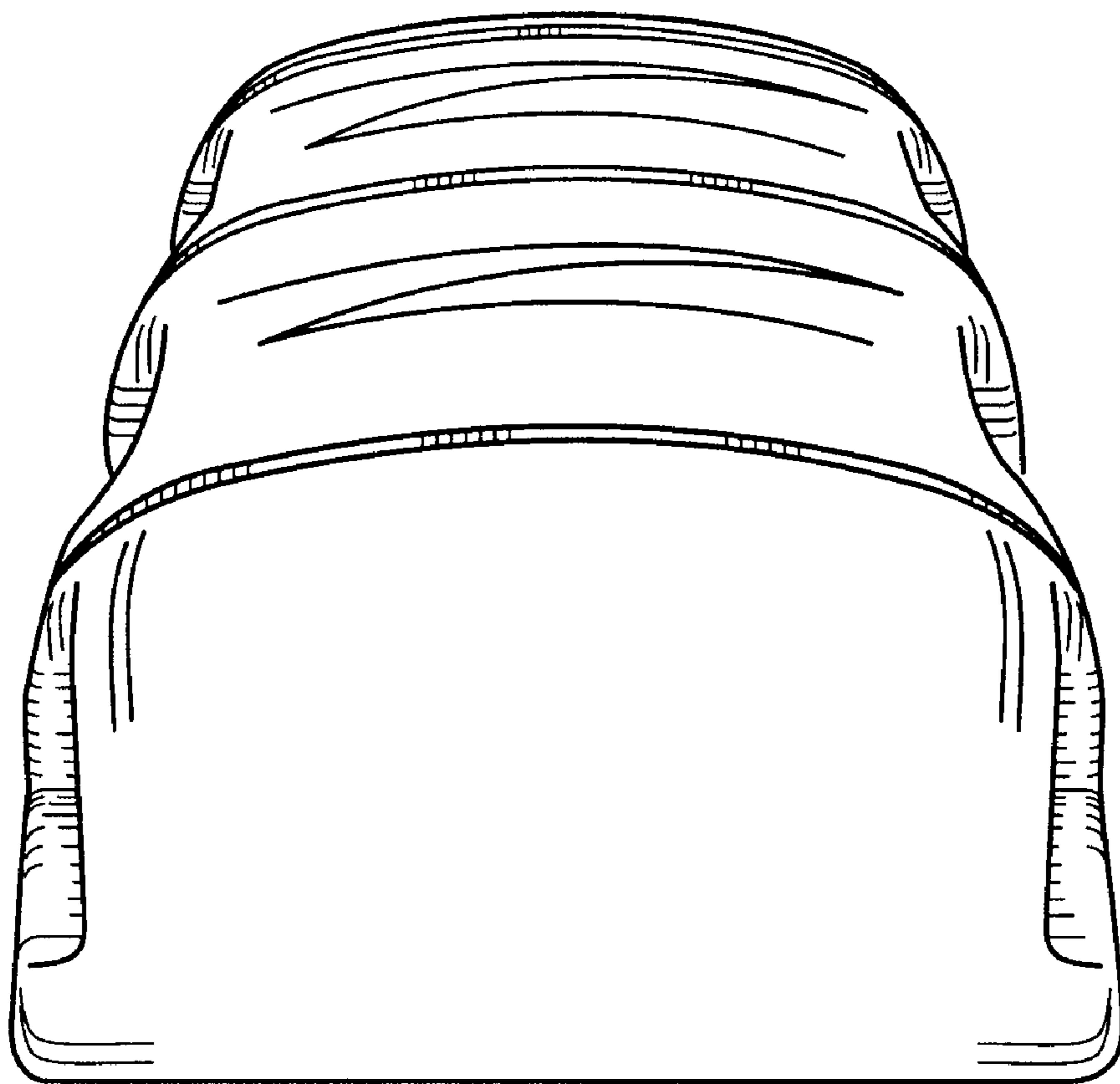

Figure 3

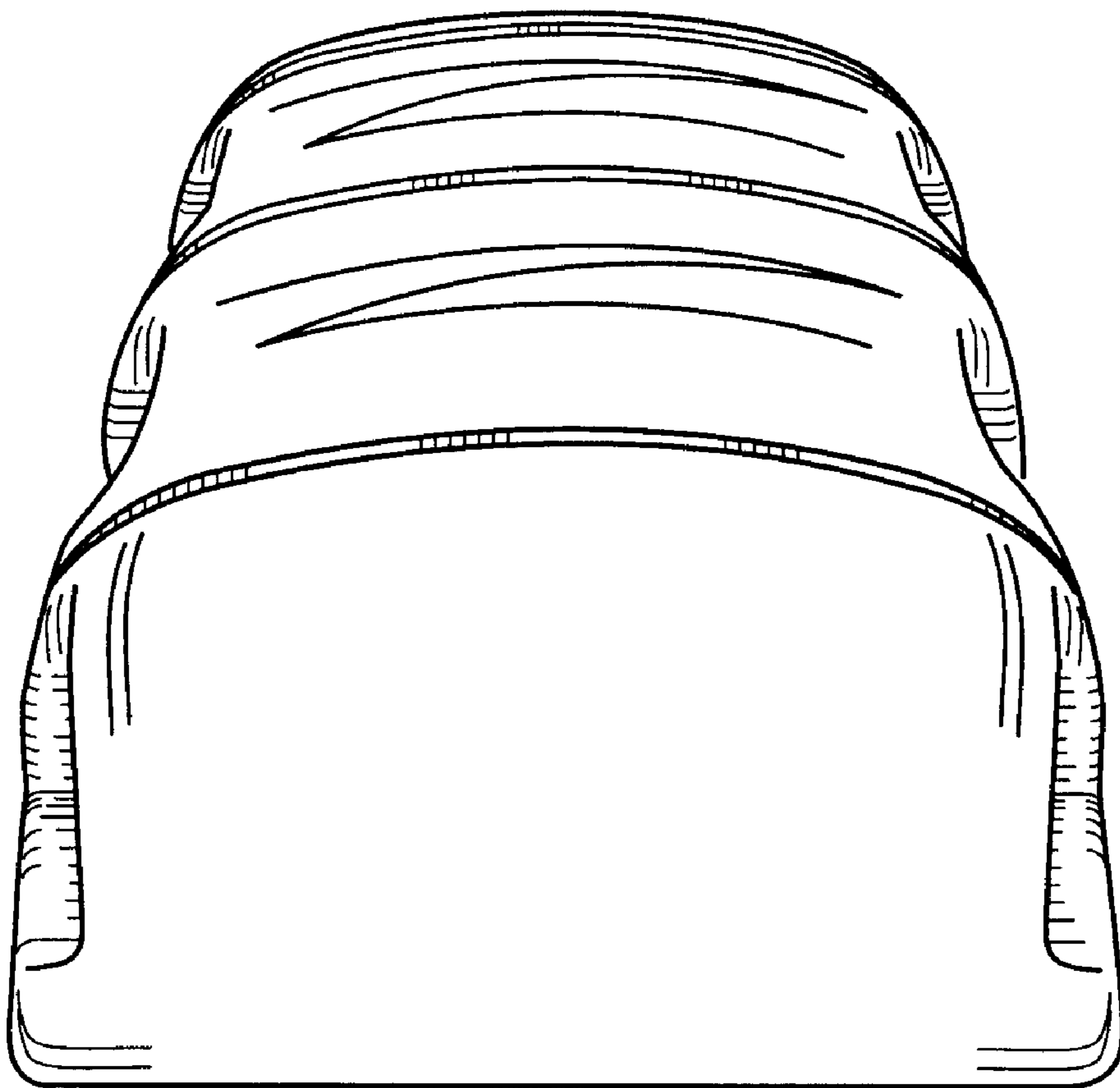

Figure 4

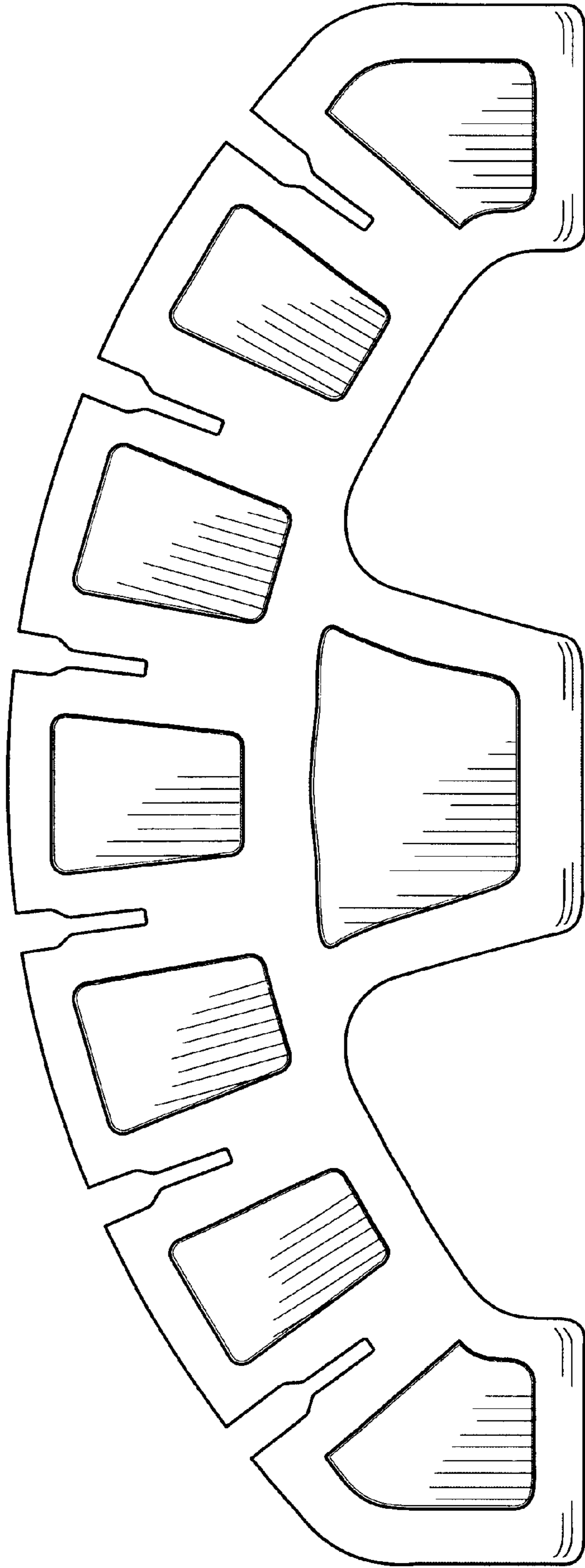

Figure 5

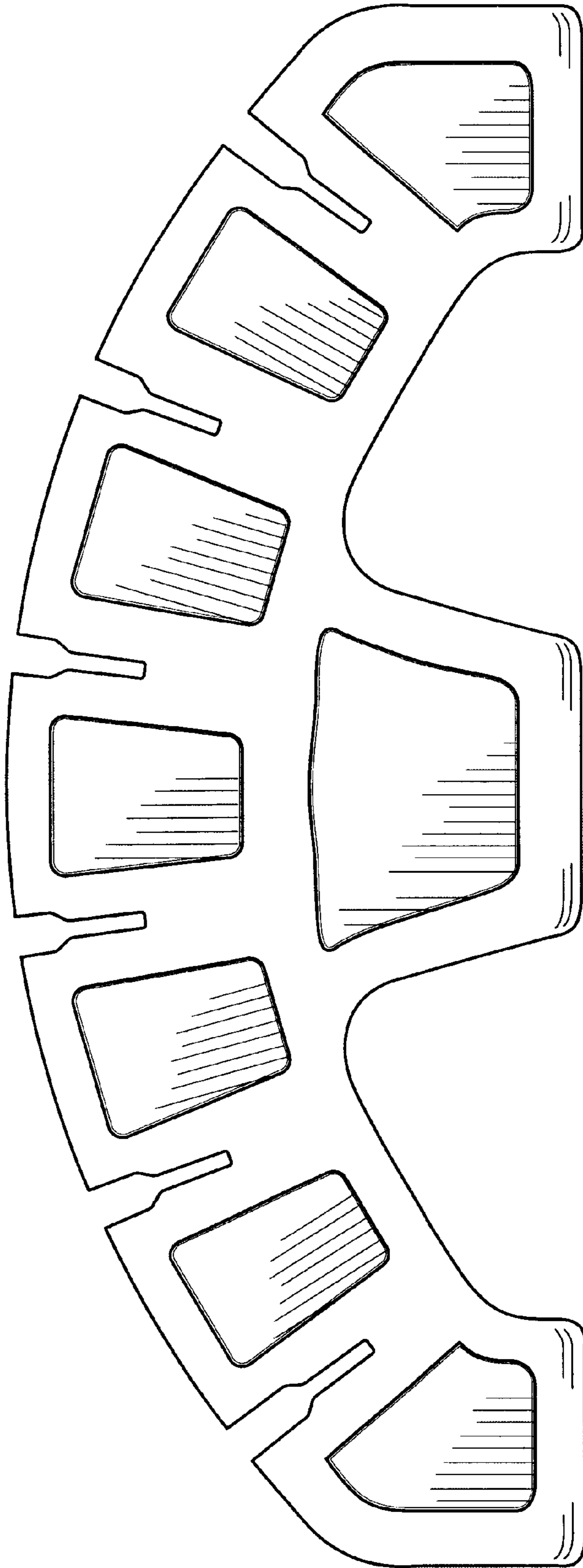

Figure 6

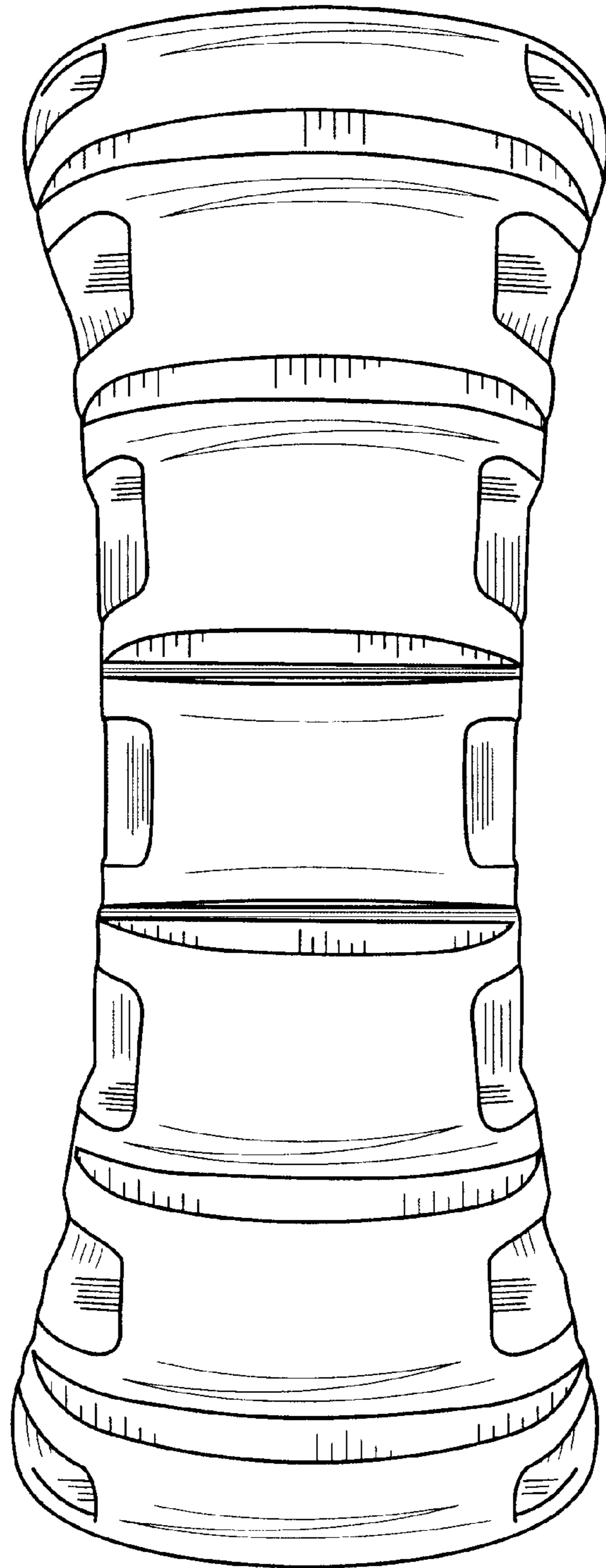

Figure 7

