



US00D469775S

(12) **United States Design Patent**
Bradley

(10) **Patent No.:** **US D469,775 S**

(45) **Date of Patent:** **** Feb. 4, 2003**

(54) **PEDESTAL COMPUTER DOCKING STATION**

(75) Inventor: **Chris Bradley**, Redwood City, CA
(US)

(73) Assignee: **Hewlett-Packard Company**, Palo Alto,
CA (US)

(**) Term: **14 Years**

(21) Appl. No.: **29/159,912**

(22) Filed: **Apr. 29, 2002**

(51) **LOC (7) Cl.** **14-02**

(52) **U.S. Cl.** **D14/434; D14/451**

(58) **Field of Search** D14/358, 432,
D14/434, 448, 451, 452; D13/107, 108;
361/679-683, 686, 687, 724; 248/441.1,
442.2, 461, 918

(56) **References Cited**

U.S. PATENT DOCUMENTS

D295,415 S * 4/1988 Thies et al. D14/452

D311,392 S * 10/1990 Hillary et al. D14/452

D317,760 S * 6/1991 Esslinger D14/451

D415,768 S * 10/1999 Howell D14/239

D427,163 S * 6/2000 Bergeron Gull et al. ... D14/452

D451,923 S * 12/2001 Lord D14/434

* cited by examiner

Primary Examiner—Kay H. Chin

(57) **CLAIM**

The ornamental design for a pedestal computer docking station, as shown and described.

DESCRIPTION

FIG. 1 is a front perspective view of a pedestal computer docking station showing my new design;

FIG. 2 is a front view thereof;

FIG. 3 is a back view thereof;

FIG. 4 is a side view, an opposing side view being the mirror image thereof;

FIG. 5 is a top view thereof; and,

FIG. 6 is a bottom view thereof.

1 Claim, 2 Drawing Sheets

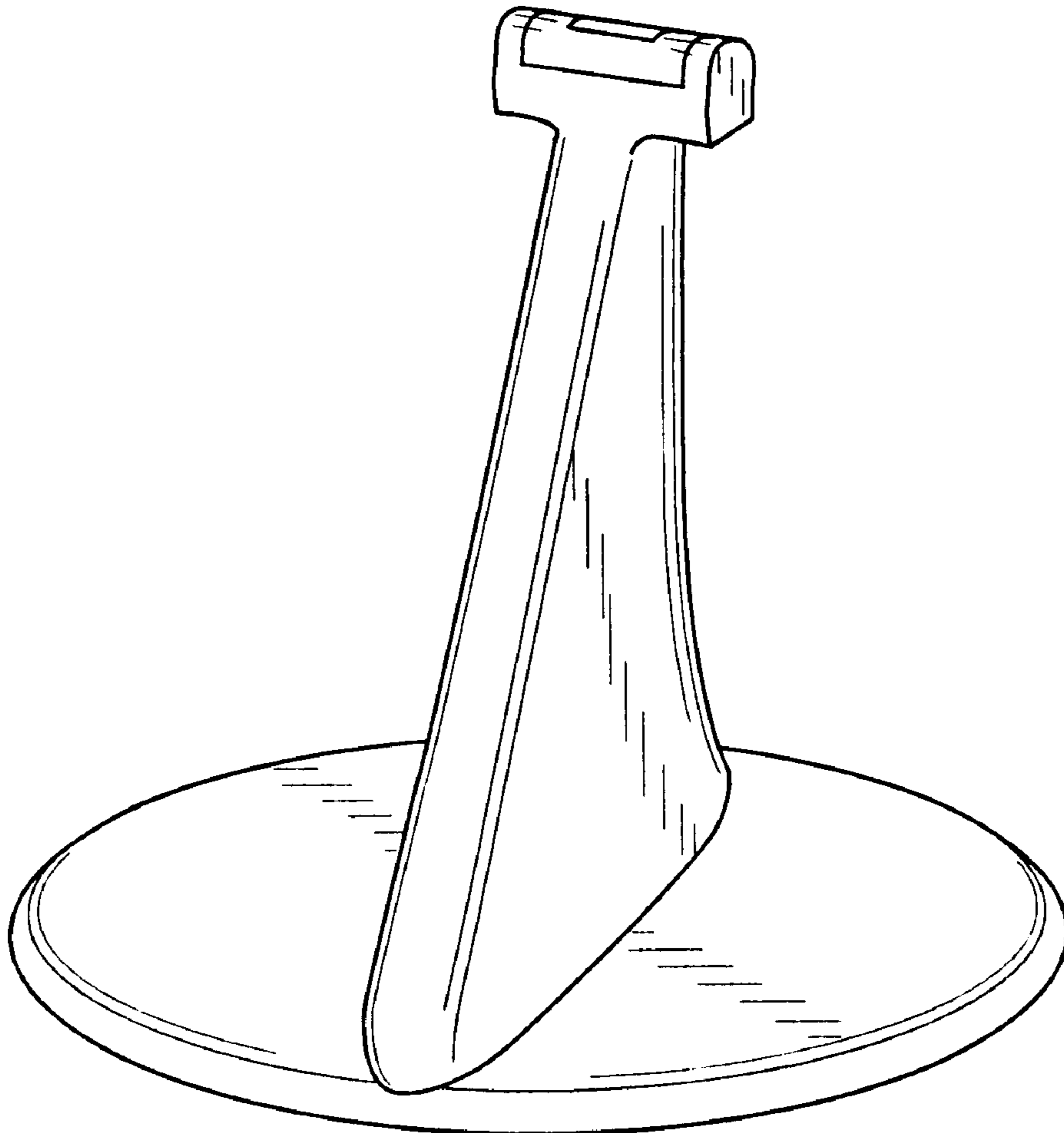

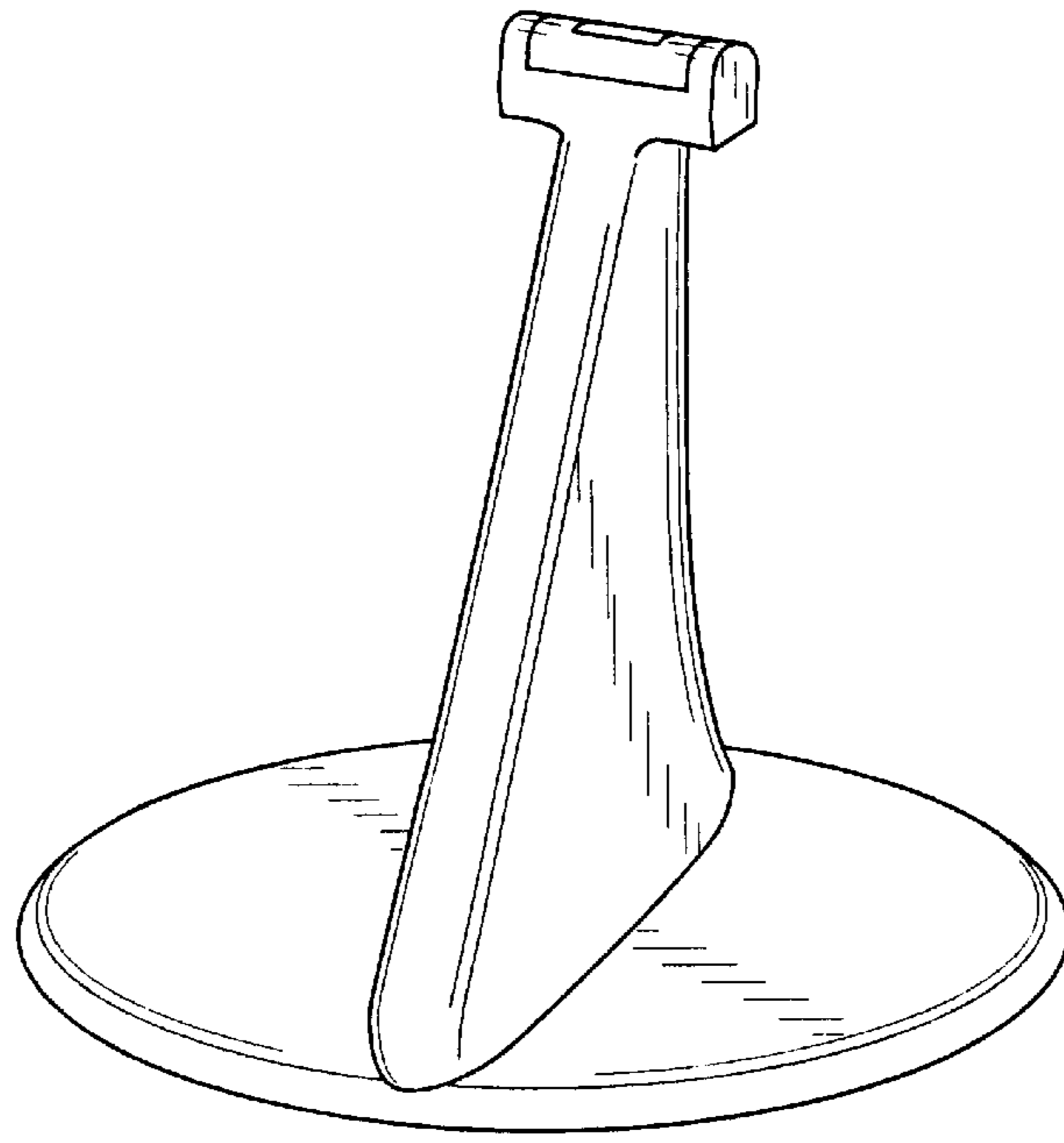

Fig. 1

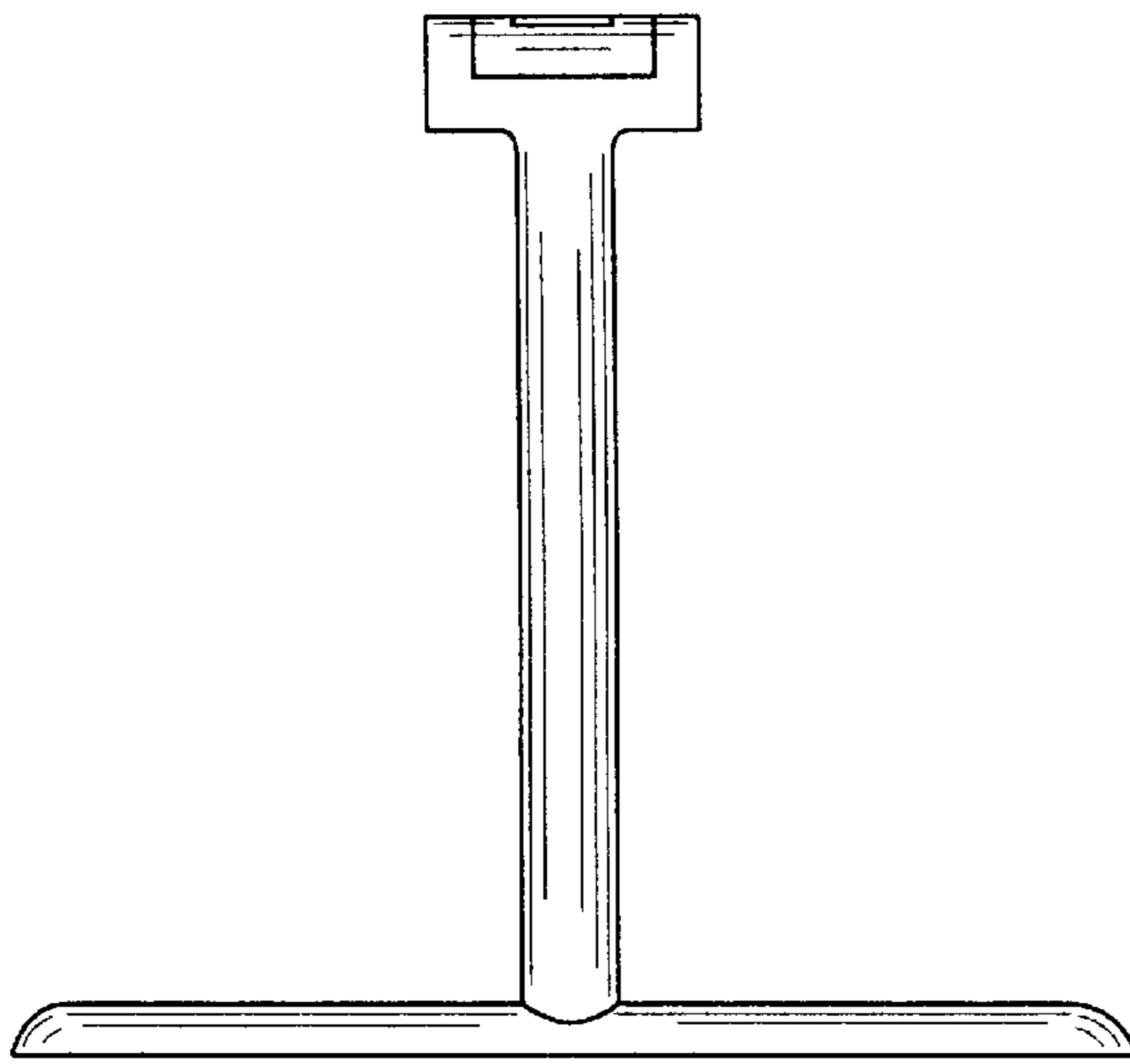

Fig. 2

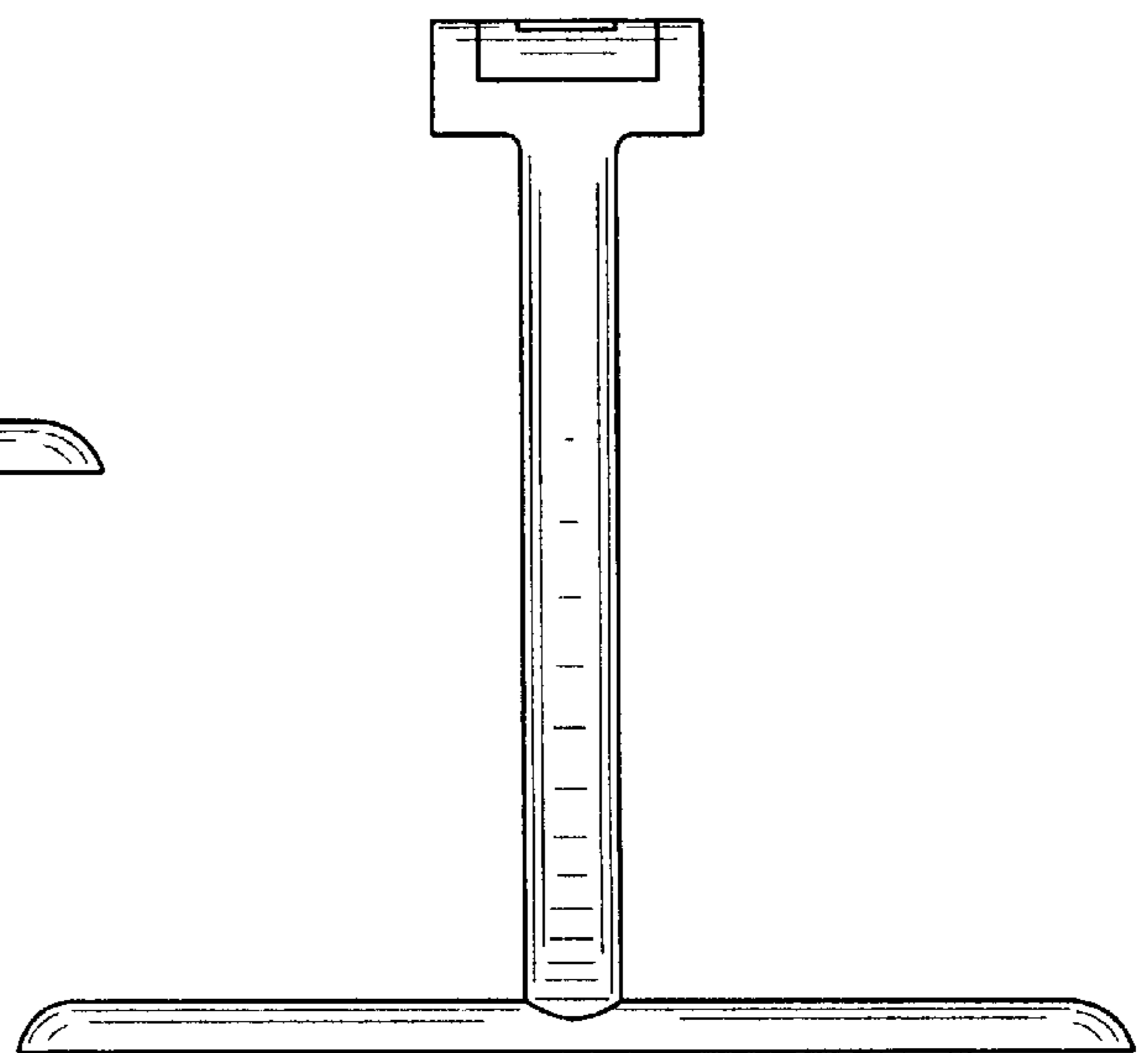

Fig. 3

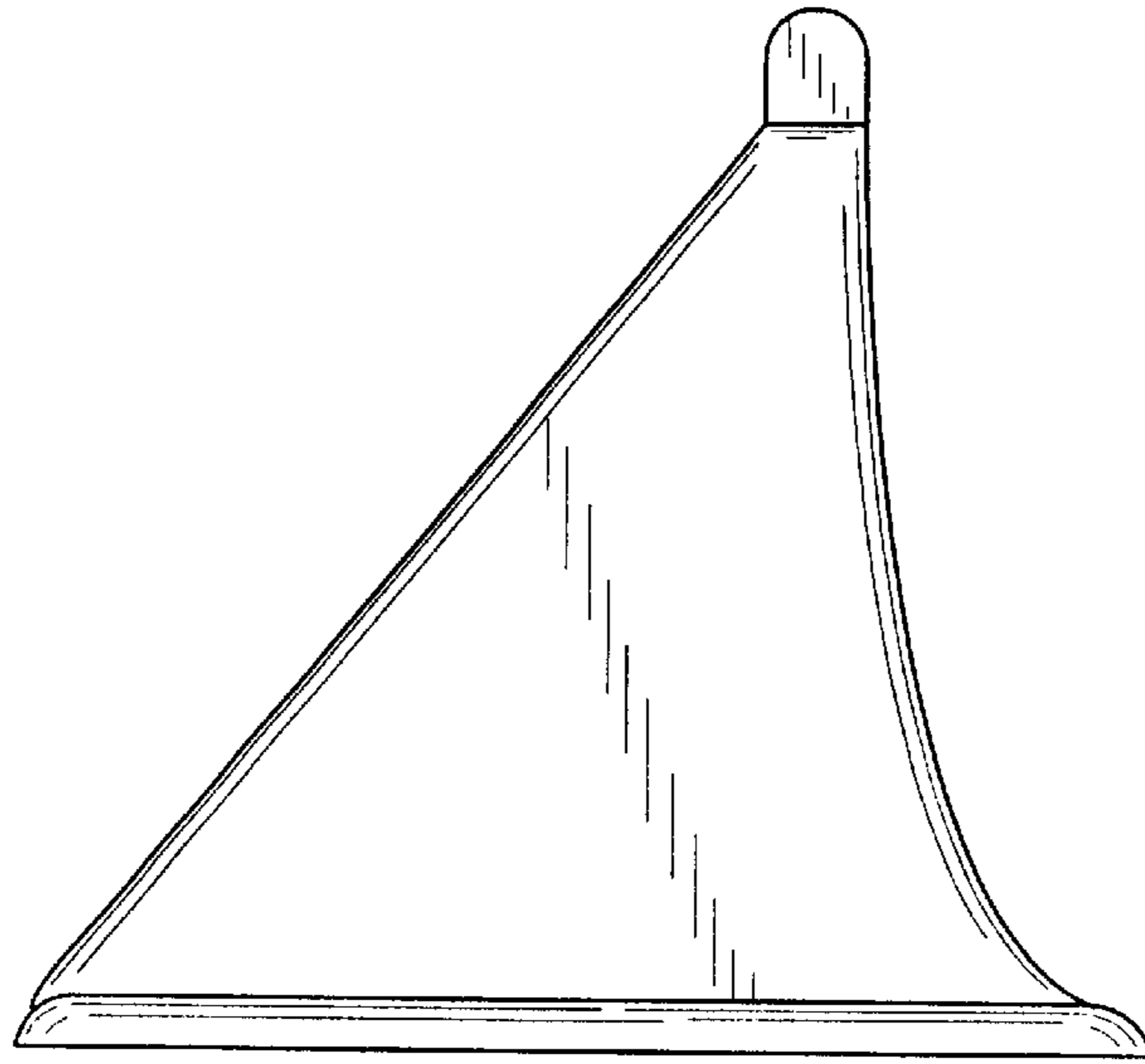

Fig. 4

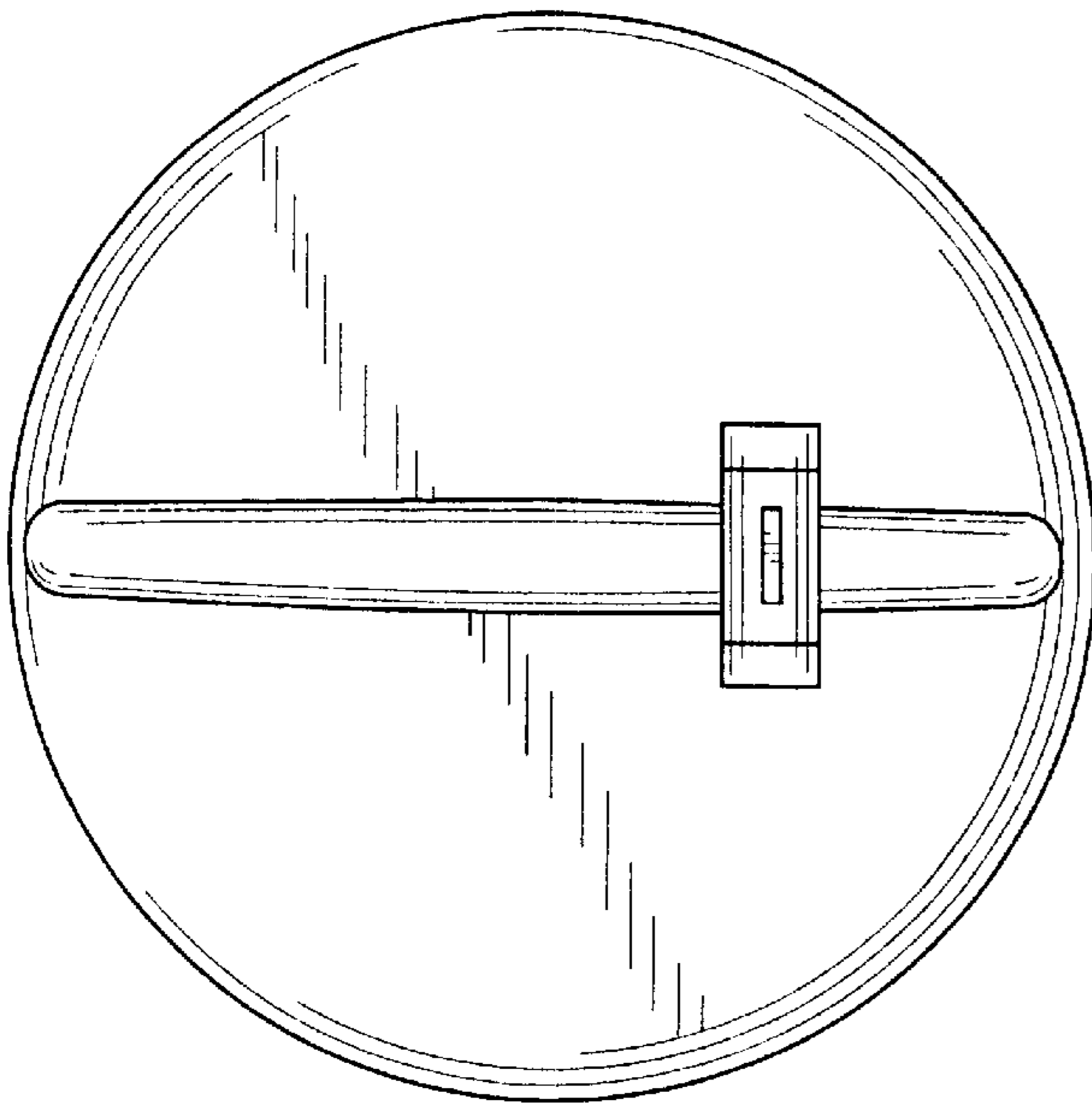

Fig. 5

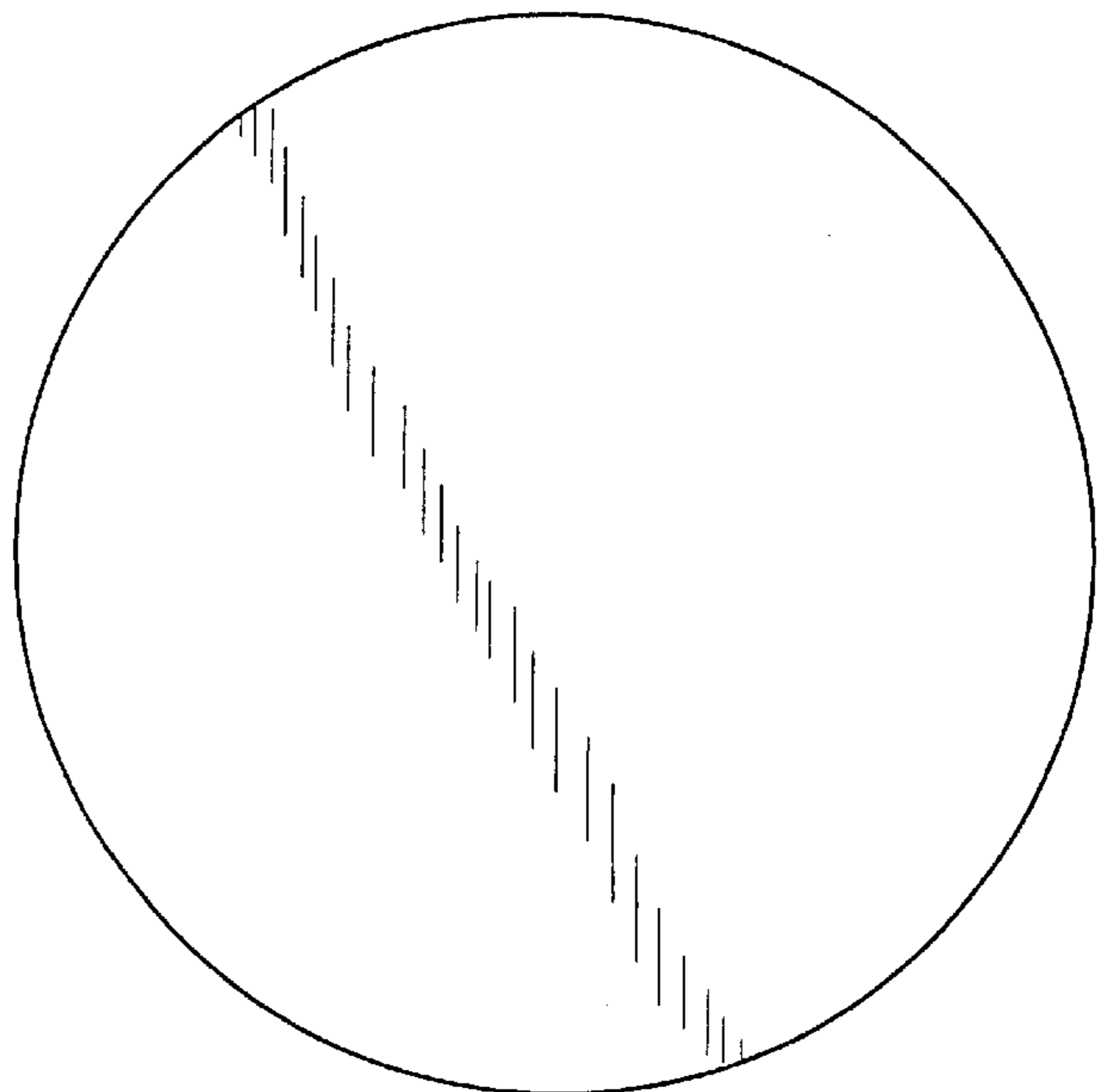

Fig. 6