



US00D469746S

(12) **United States Design Patent**  
**Soule, Jr.**

(10) **Patent No.:** **US D469,746 S**

(45) **Date of Patent:** **\*\* Feb. 4, 2003**

(54) **EMERGENCY MEDICAL VIDEO-CONFERENCING UNIT**  
(75) **Inventor:** **Robert M. Soule, Jr.**, Bedford, TX (US)

(73) **Assignee:** **Emtel, Inc.**, Houston, TX (US)

(\*\*) **Term:** **14 Years**

(21) **Appl. No.:** **29/157,222**

(22) **Filed:** **Mar. 14, 2002**

(51) **LOC (7) Cl.** ..... **14-03**

(52) **U.S. Cl.** ..... **D14/127**

(58) **Field of Search** ..... D14/373, 371, D14/306, 125-136, 239; D16/203, 221-233; 248/917, 918; 312/198, 231; 211/134; 345/1; 348/180, 184, 739, 13-17; 379/433-436, 93.17

(56) **References Cited**

**U.S. PATENT DOCUMENTS**

D236,268 S	*	8/1975	Dallimonti	
4,113,331 A	*	9/1978	Derdzinski	312/198
D347,839 S	*	6/1994	Carota	D16/203
D378,677 S	*	4/1997	Matsumoto et al.	
D395,041 S	*	6/1998	Leveridge et al.	
D440,543 S	*	4/2001	Kodimer	D14/127
D442,155 S	*	5/2001	Pham et al.	D14/130

\* cited by examiner

*Primary Examiner*—Raphael Barkai

(74) *Attorney, Agent, or Firm*—James L. Jackson; Andrews & Kurth, LLP

(57) **CLAIM**

The ornamental design for an emergency medical video-conferencing unit, as shown and described.

**DESCRIPTION**

FIG. 1 is an isometric illustration showing the front, top and one side of the emergency medical video-conferencing unit of the design;

FIG. 2 is a plan view of the emergency medical video-conferencing unit of the design;

FIG. 3 is a front elevational view of the emergency medical video-conferencing unit of the design;

FIG. 4 is a side elevational view of the emergency medical video-conferencing unit of the design, the opposite side elevational view being a mirror image thereof;

FIG. 5 is a rear elevational view of the emergency medical video-conferencing unit design; and,

FIG. 6 is an isometric view showing the closed condition of the emergency medical video-conferencing unit of the design.

**1 Claim, 3 Drawing Sheets**

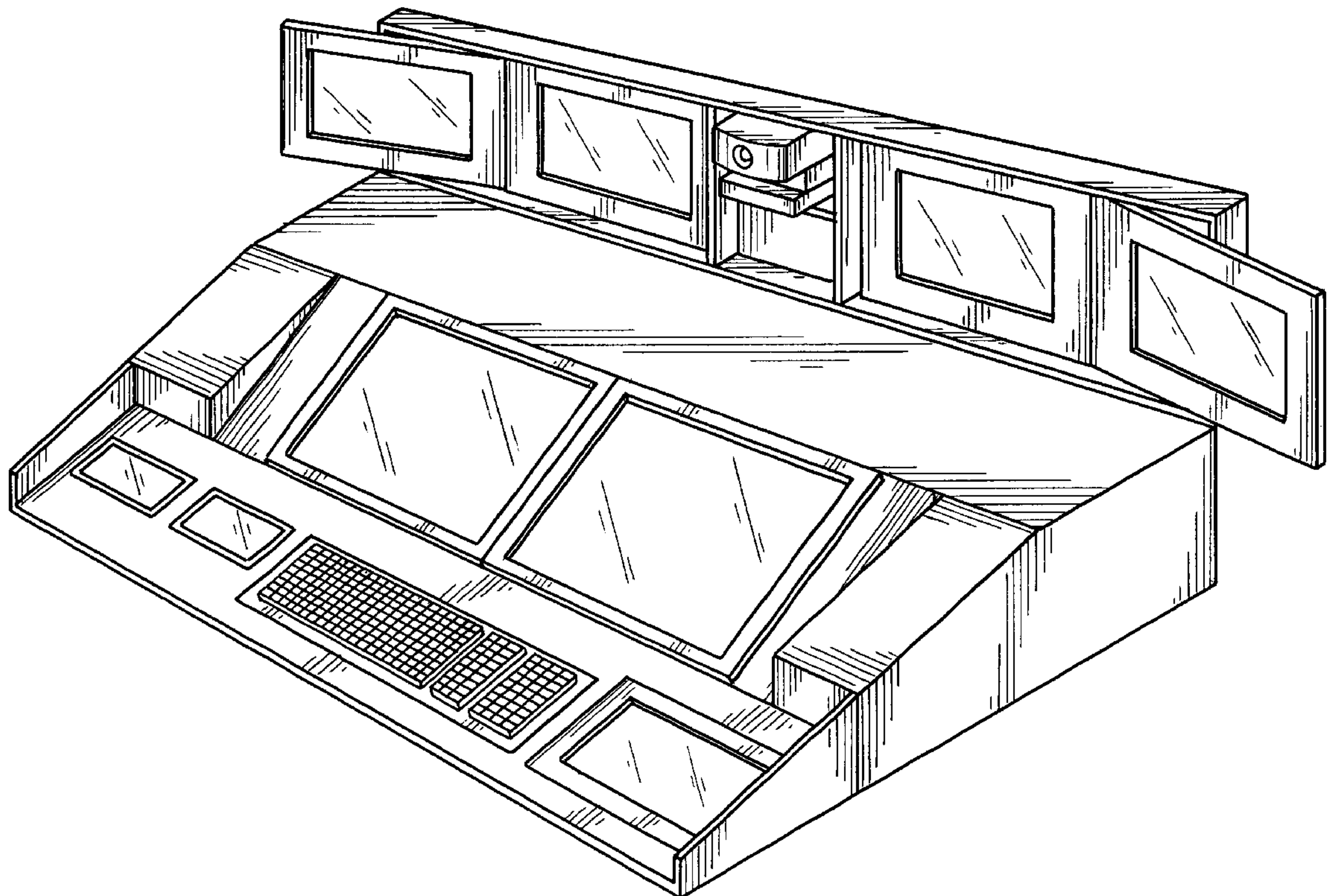

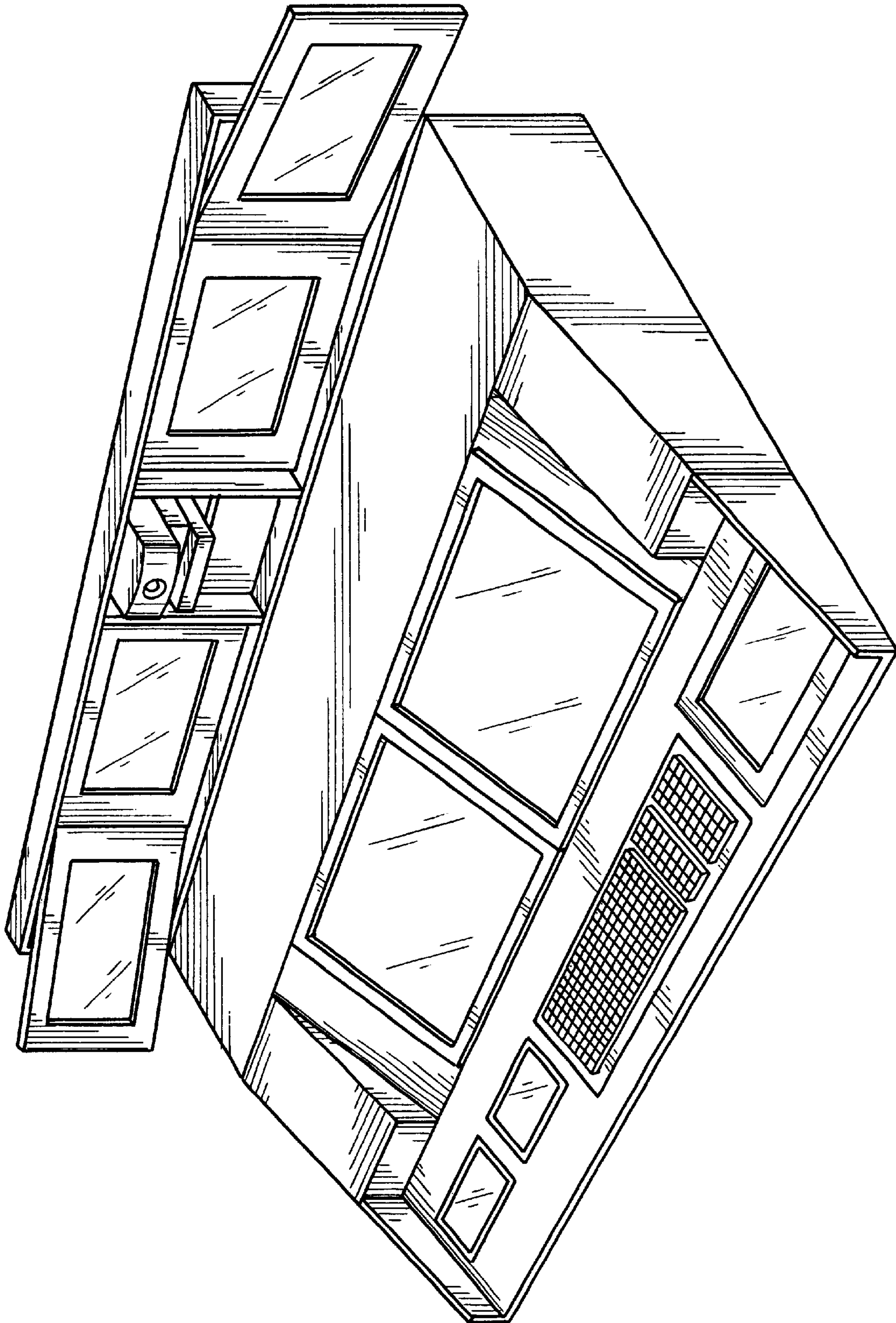

FIG. 1

FIG. 2

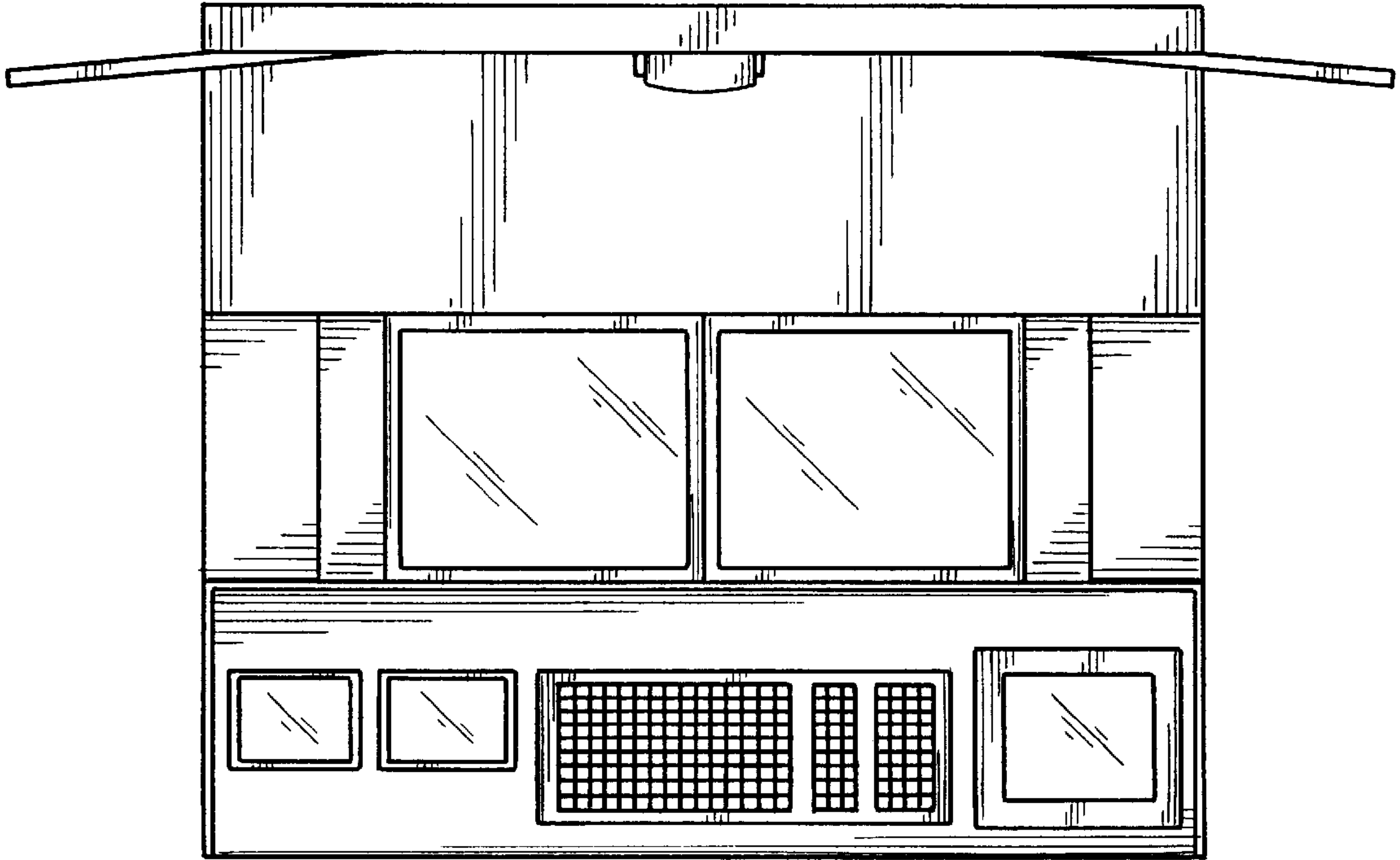

FIG. 3

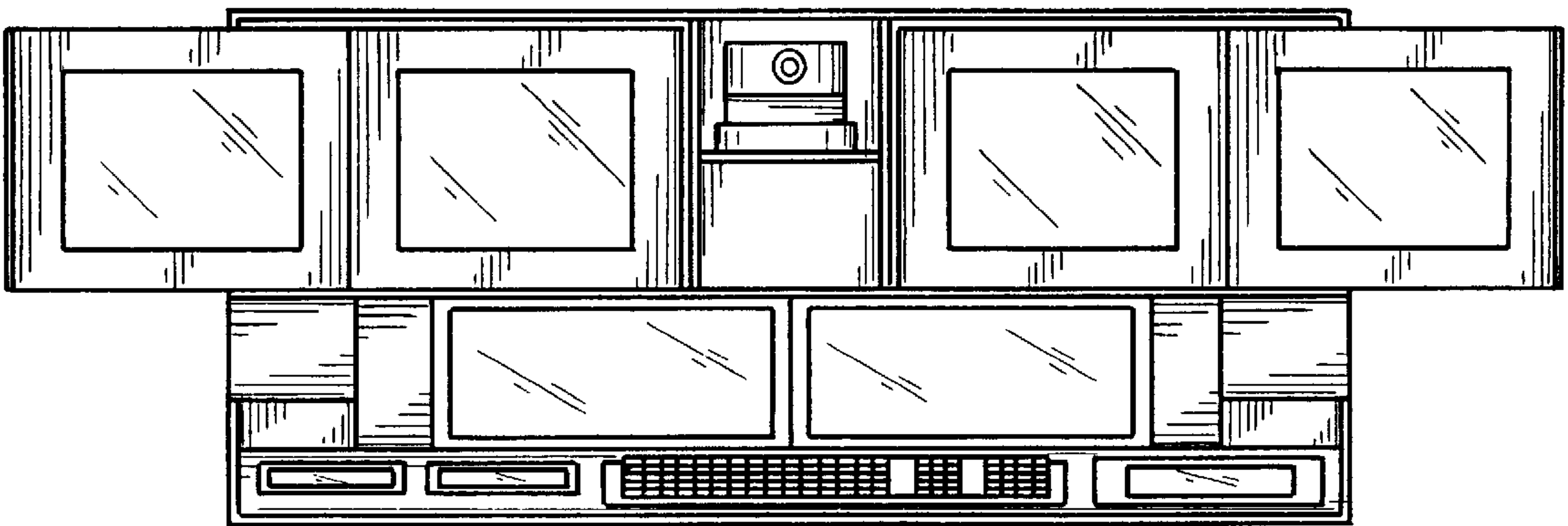



FIG. 4

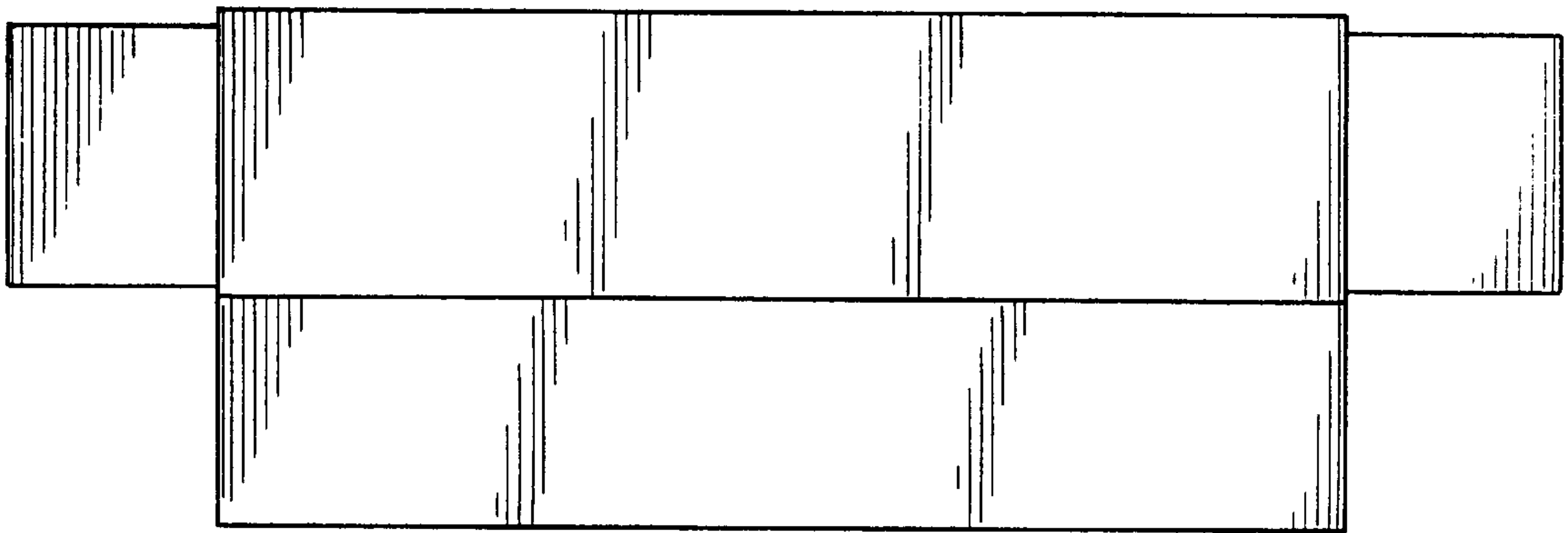
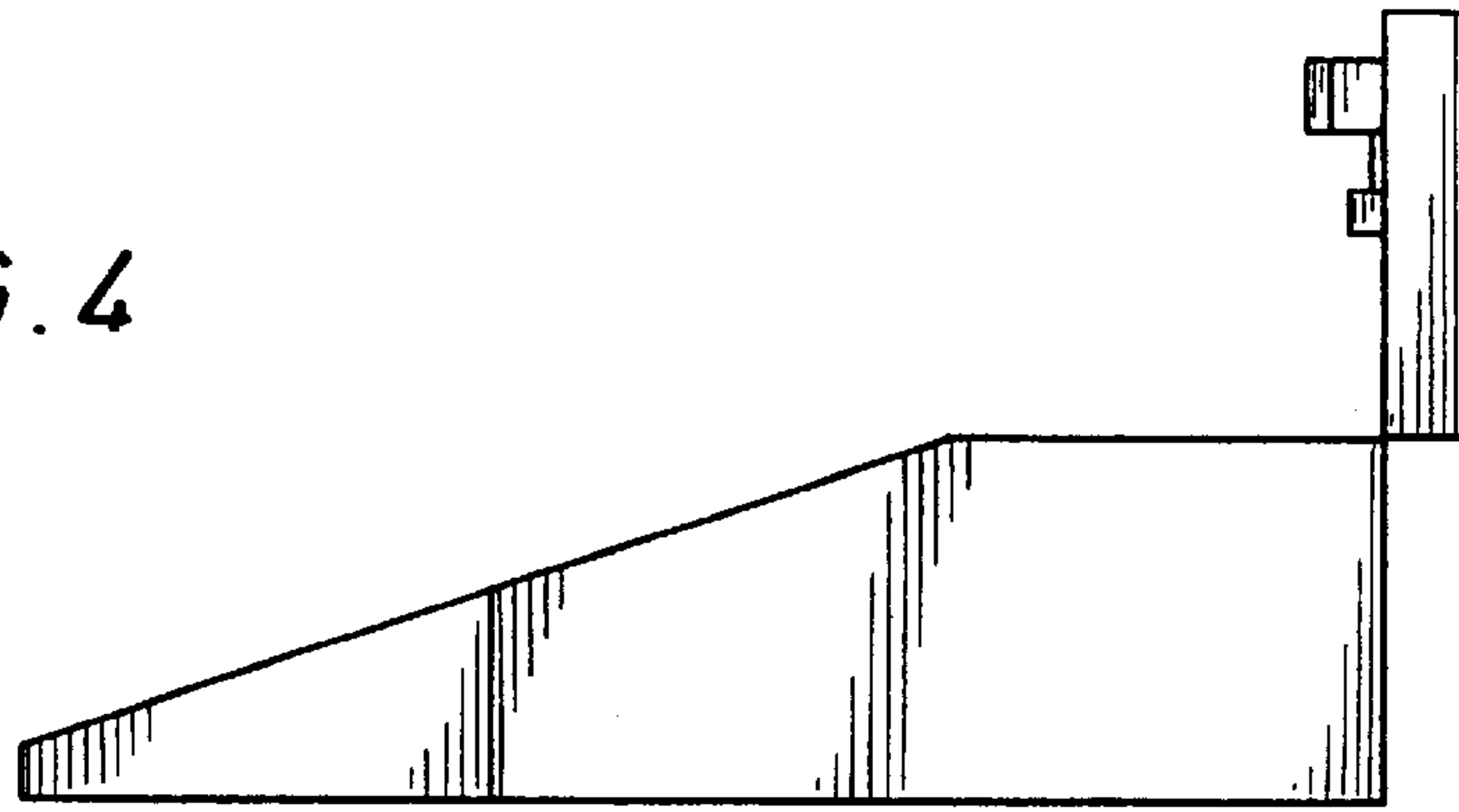

FIG. 5

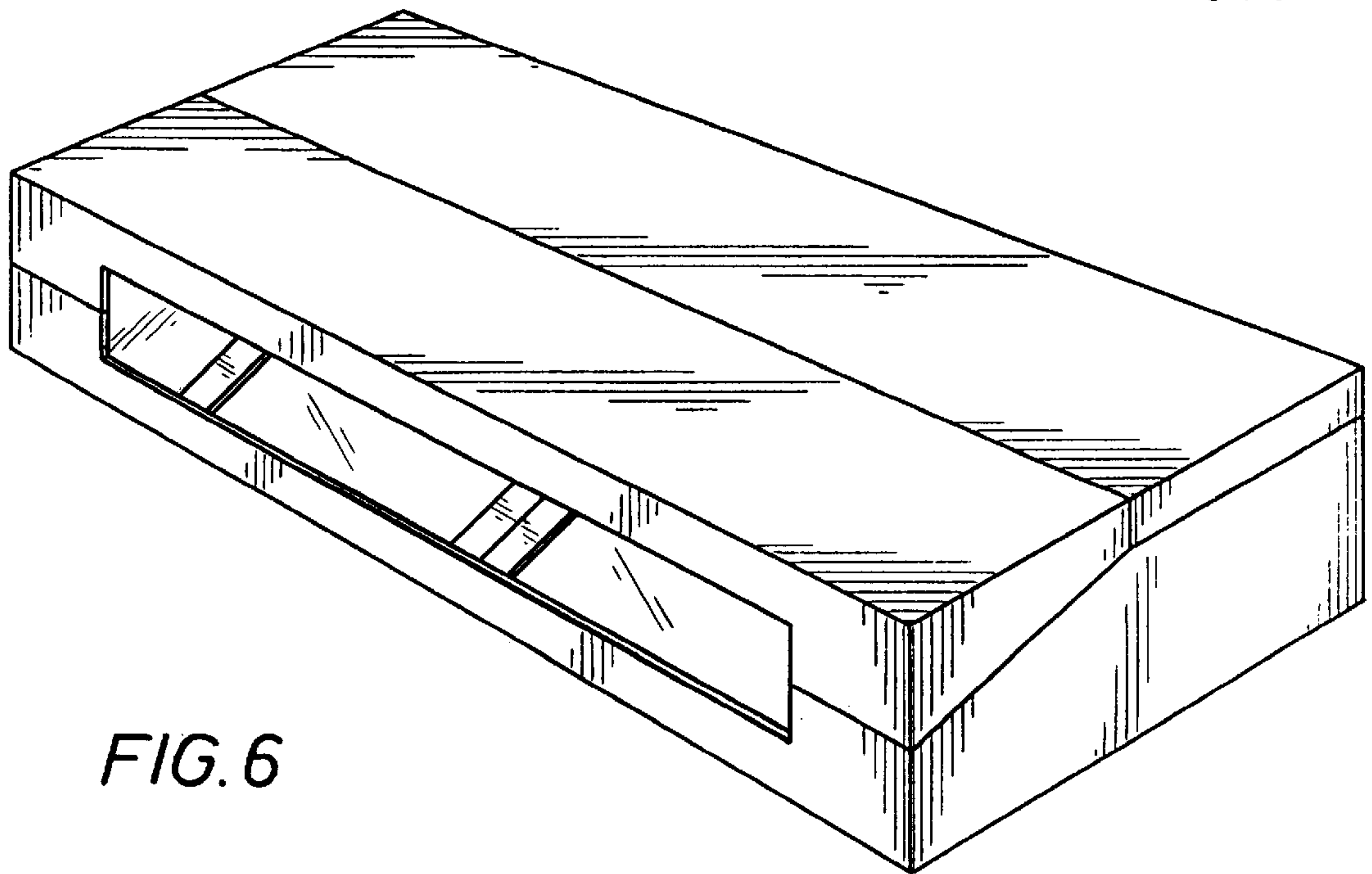

FIG. 6