



US00D469255S

(12) **United States Design Patent**
Hammett

(10) **Patent No.:** **US D469,255 S**

(45) **Date of Patent:** **** Jan. 28, 2003**

(54) **BEVERAGE TRAY**

(76) Inventor: **Roy Hammett**, 16103 Carden Dr.,
Odessa, FL (US) 33556

(**) Term: **14 Years**

(21) Appl. No.: **29/141,522**

(22) Filed: **May 8, 2001**

(51) **LOC (7) Cl.** **03-01**

(52) **U.S. Cl.** **D3/314**

(58) **Field of Search** D3/304-315; 220/1.5,
220/7, 509, 516, 519, 771, 772, 755, 756,
669, 675; 206/429, 503, 509, 510, 557

(56) **References Cited**

U.S. PATENT DOCUMENTS

5,060,819 A	*	10/1991	Apps	206/203
5,979,654 A	*	11/1999	Apps	206/506
6,006,912 A	*	12/1999	McGrath	206/505

* cited by examiner

Primary Examiner—Louis S. Zarfaz

Assistant Examiner—Deanne Levy

(74) *Attorney, Agent, or Firm*—Dennis H. Lambert

(57) **CLAIM**

The ornamental design for a beverage tray, as shown and described.

DESCRIPTION

FIG. 1 is a top perspective view of the beverage tray design of my invention;

FIG. 2 is a bottom perspective view of the tray of FIG. 1;

FIG. 3 is a side view in elevation of the tray of FIG. 1, the opposite side being a mirror image;

FIG. 4 is an end view in elevation of the tray of FIG. 1, the end opposite being a mirror image;

FIG. 5 is a top plan view of the tray of FIG. 1; and,

FIG. 6 is a bottom plan view of the tray of FIG. 1.

1 Claim, 5 Drawing Sheets

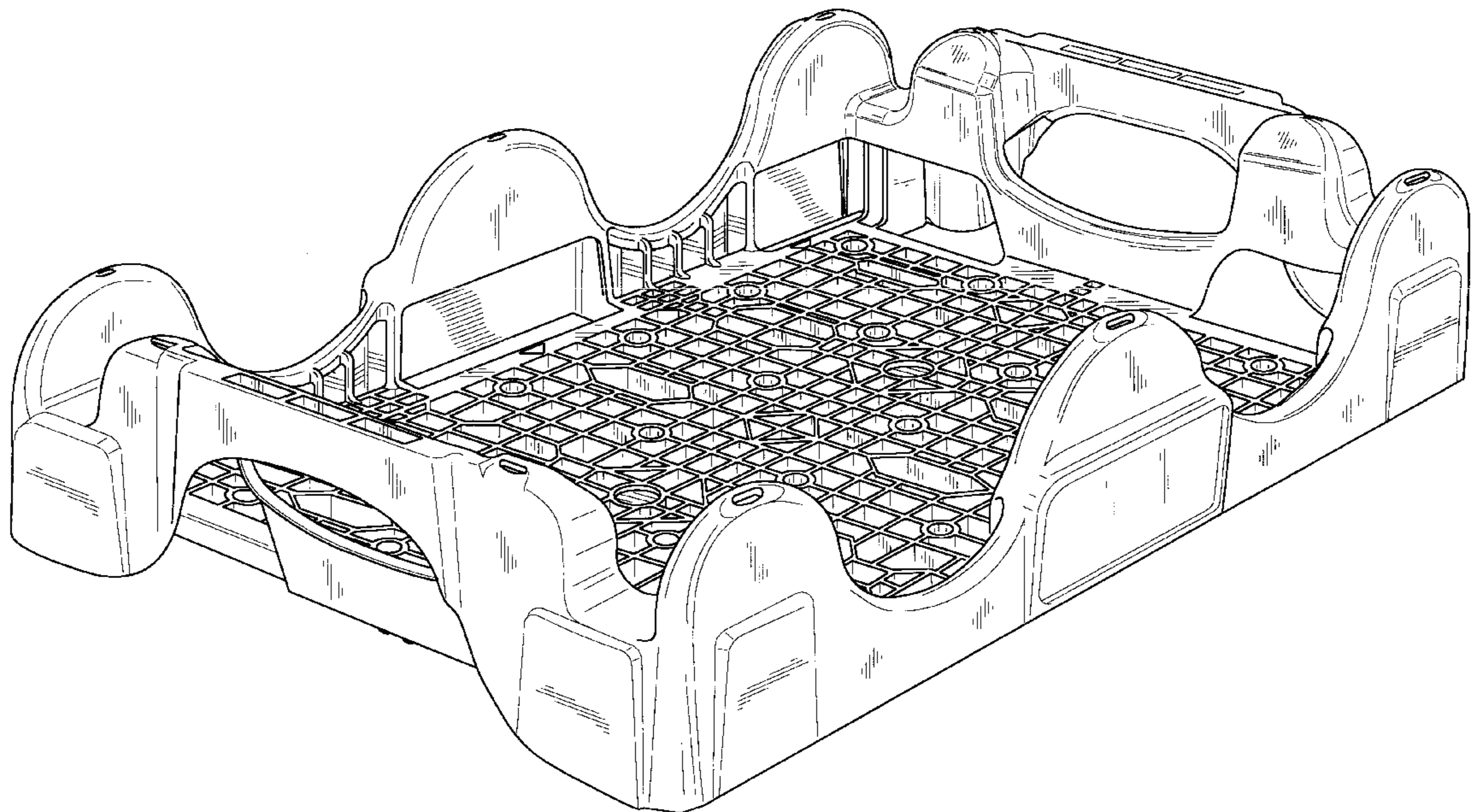

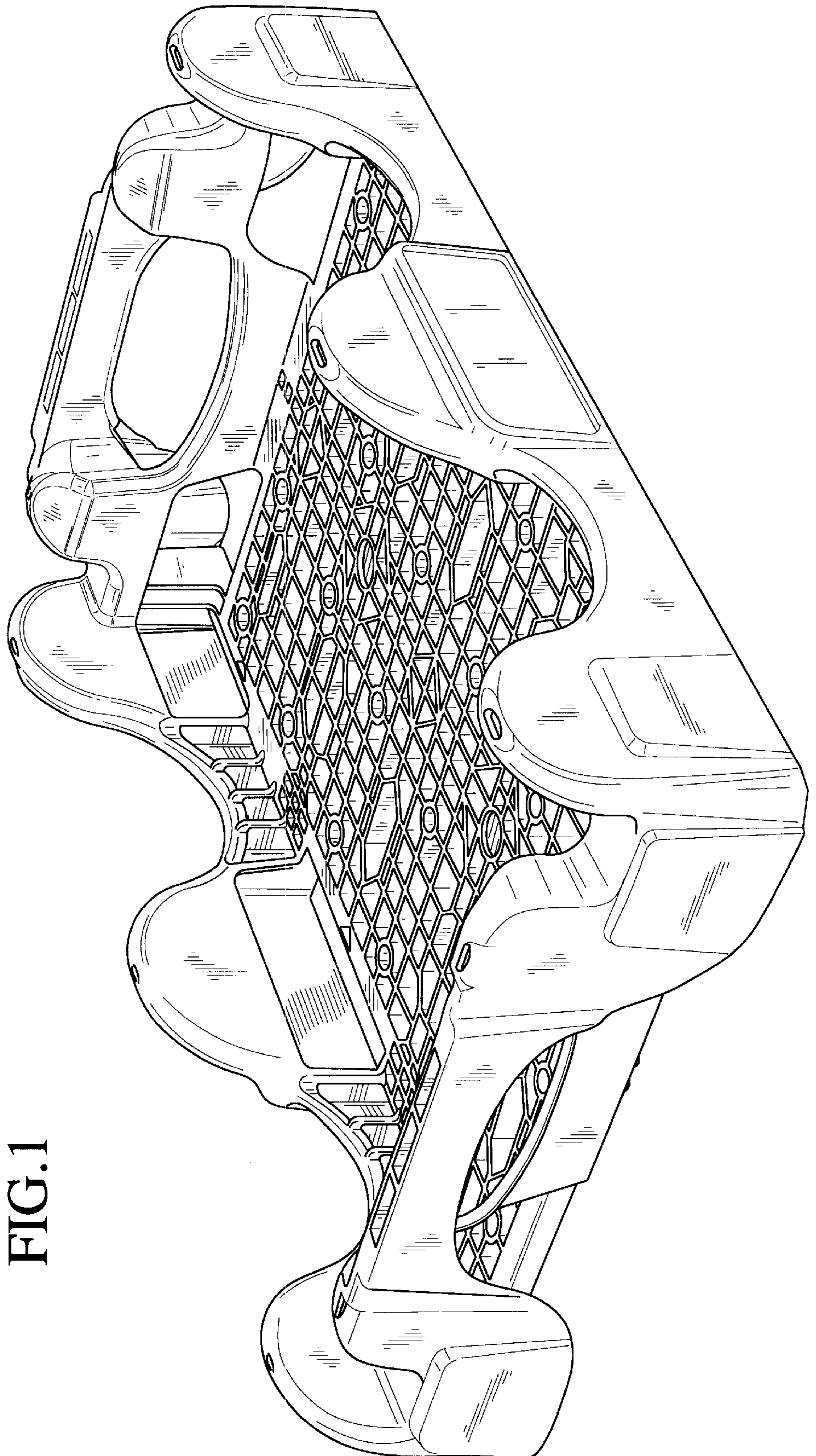

FIG. 1

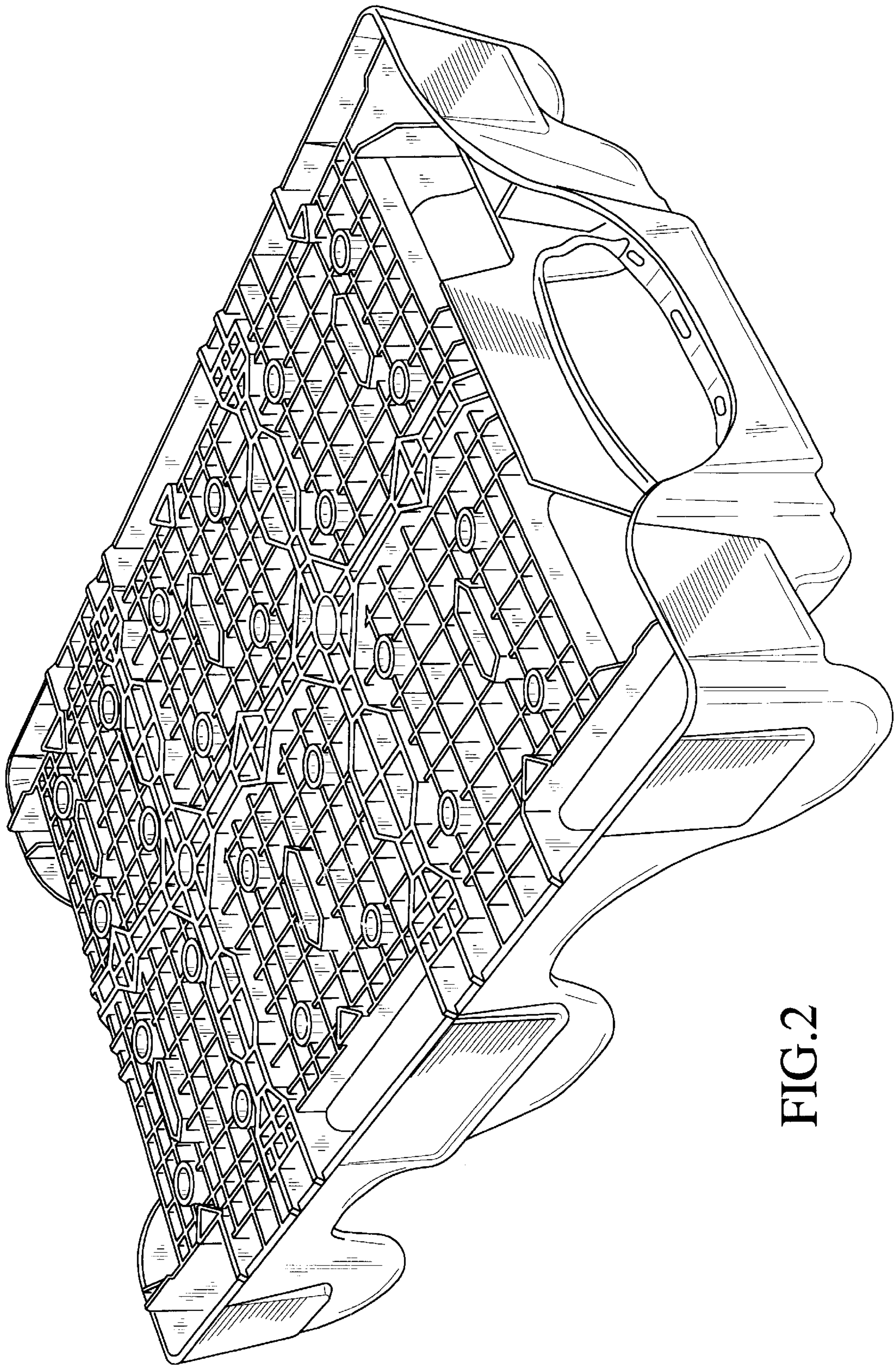

FIG.2

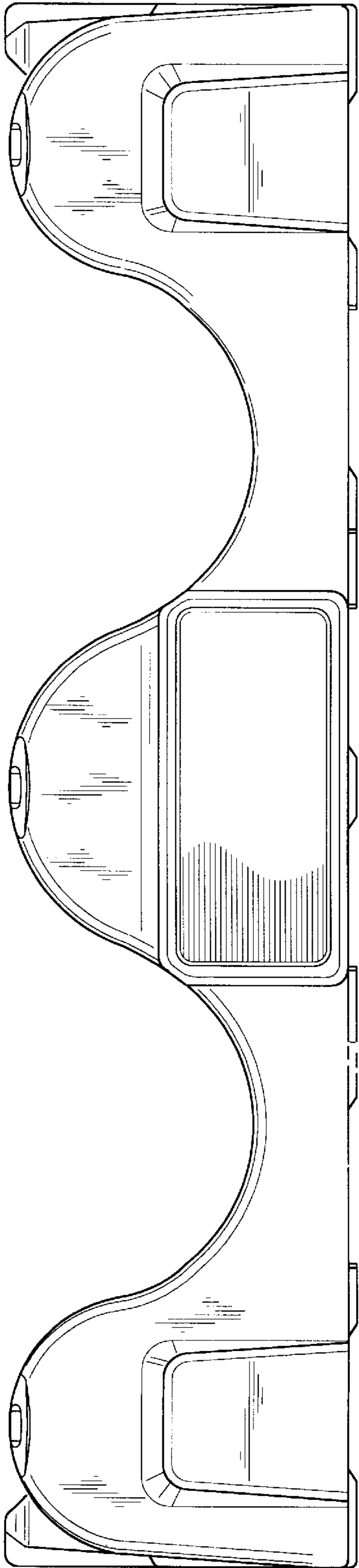

FIG. 3

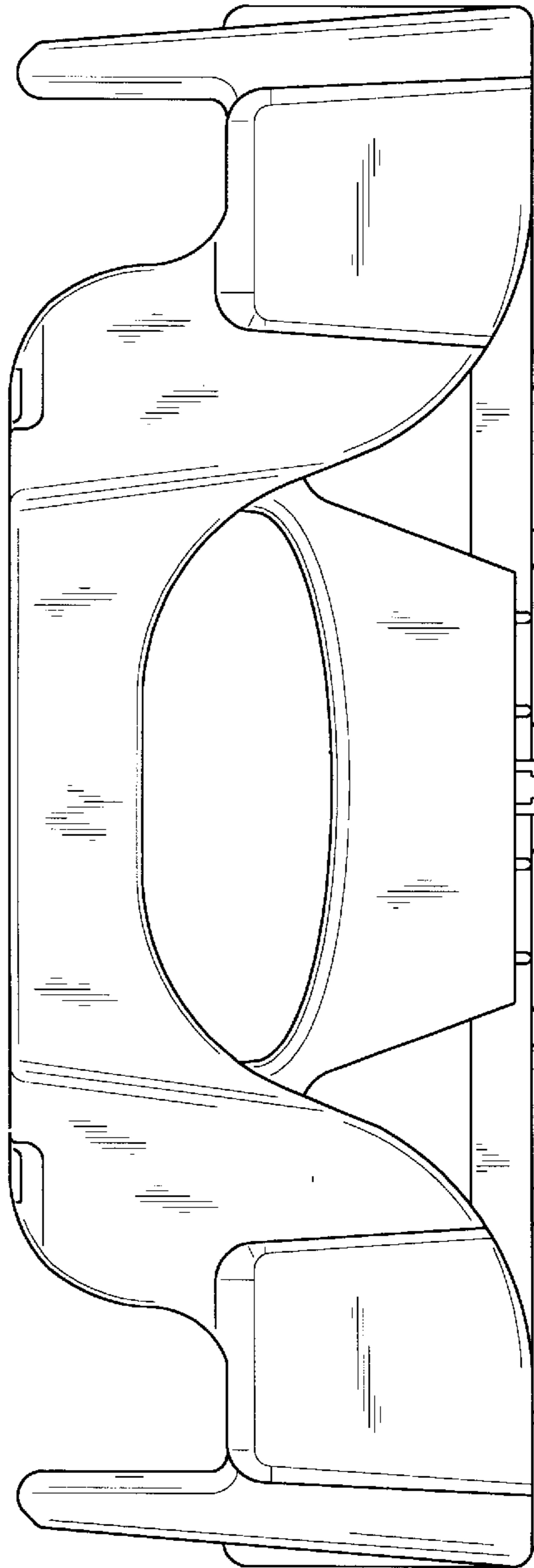

FIG. 4

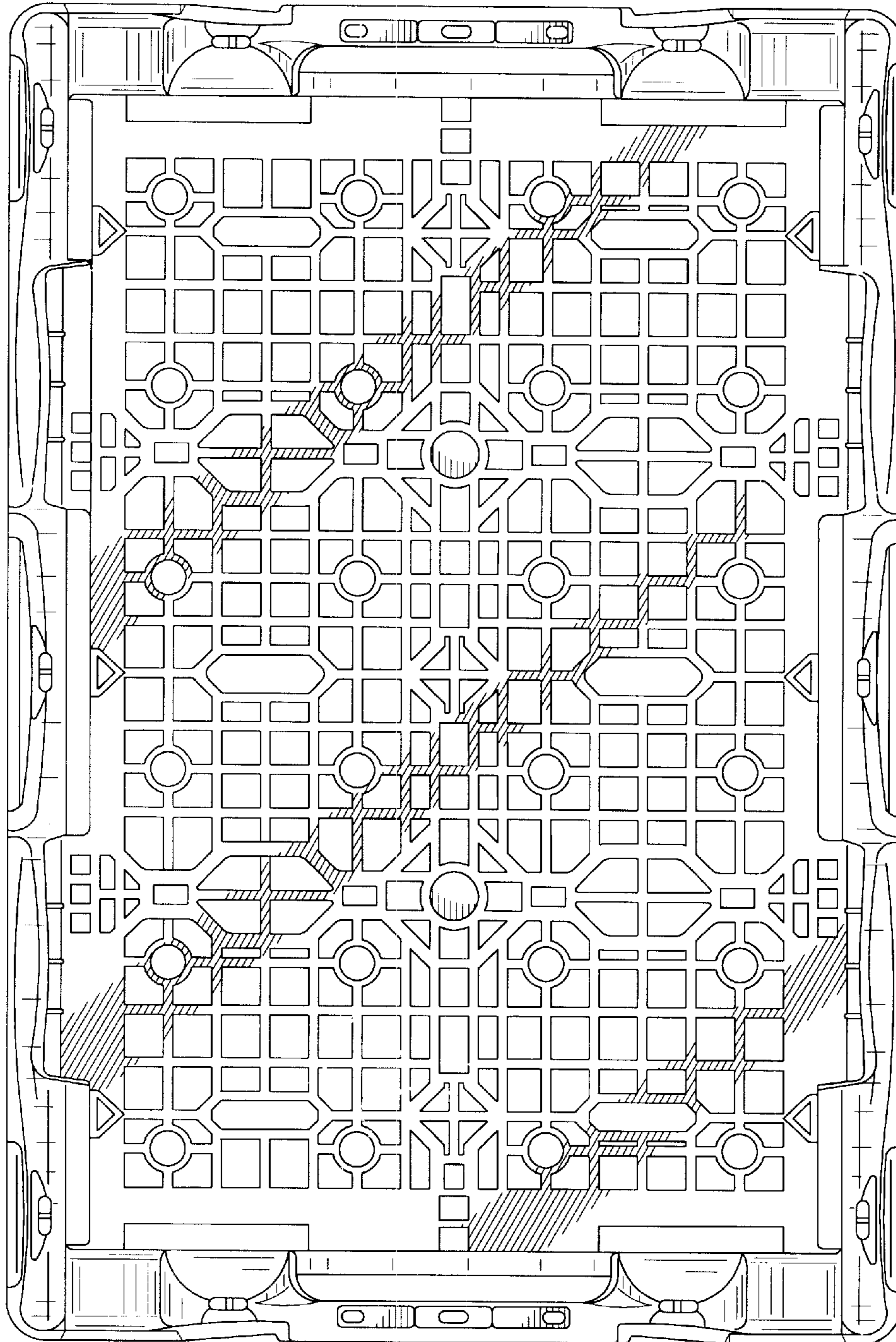

FIG. 5

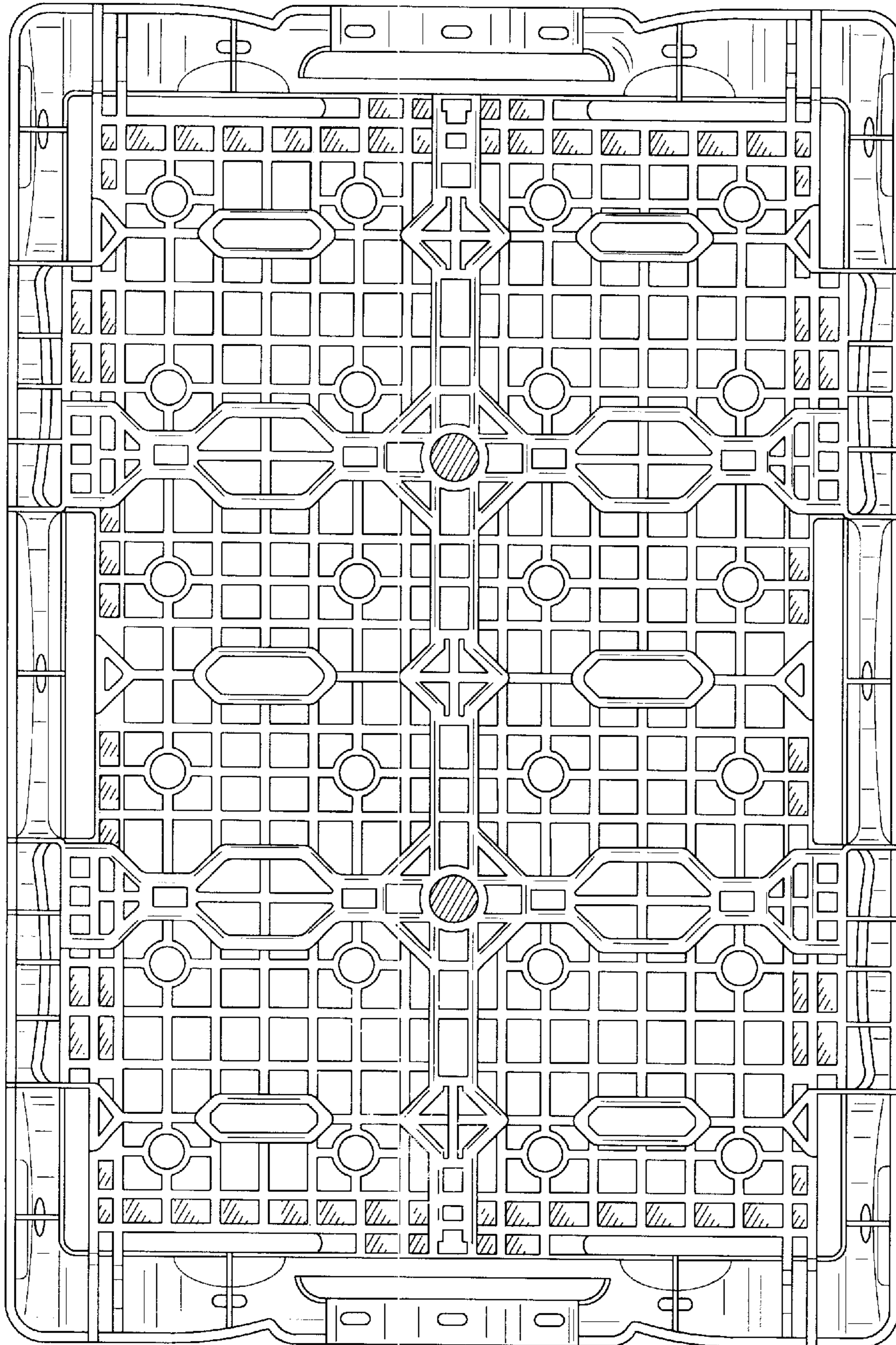

FIG.6