



US00D469103S

(12) **United States Design Patent**  
**Nakata et al.**

(10) **Patent No.:** **US D469,103 S**

(45) **Date of Patent:** **\*\* Jan. 21, 2003**

(54) **DISC CARTRIDGE**

(75) Inventors: **Kuniko Nakata**, Osaka (JP); **Teruyuki Takizawa**, Osaka (JP); **Yoshito Saji**, Hyogo (JP); **Hironori Okazawa**, Osaka (JP)

(73) Assignee: **Matsushita Electric Industrial Co., Ltd.**, Osaka (JP)

(\*\*) Term: **14 Years**

(21) Appl. No.: **29/153,999**

(22) Filed: **Oct. 25, 2001**

(30) **Foreign Application Priority Data**

Jul. 16, 2001 (JP) ..... 2001-020746

(51) **LOC (7) Cl.** ..... **14-02**

(52) **U.S. Cl.** ..... **D14/478**

(58) **Field of Search** ..... D14/432-3, 436, D14/474, 478-80; 360/60, 129, 131-3, 135, 97.01-99.12; 206/307, 308.3, 312, 472; 369/272, 273, 291, 77.2

(56) **References Cited**

**U.S. PATENT DOCUMENTS**

- D312,077 S \* 11/1990 Sasaki et al.
- D325,468 S \* 4/1992 Ohba
- D370,009 S \* 5/1996 Smedley, Jr. et al.
- D371,548 S \* 7/1996 Yamamoto et al.

- D377,344 S \* 1/1997 Yamamoto et al.
- D420,337 S \* 2/2000 Mori
- D425,876 S \* 5/2000 Maiers et al.
- D435,854 S \* 1/2001 Takagi et al.

**FOREIGN PATENT DOCUMENTS**

- JP 1060540 2/2000
- JP 1071145 5/2000

\* cited by examiner

*Primary Examiner*—M. H. Tung

(74) *Attorney, Agent, or Firm*—Christensen O'Connor Johnson Kindness PLLC

(57) **CLAIM**

The ornamental design for a disc cartridge, as shown and described.

**DESCRIPTION**

FIG. 1 is a perspective view of the front, bottom and right side of a disc cartridge showing our new design;  
 FIG. 2 is a front view thereof;  
 FIG. 3 is a top plan view thereof;  
 FIG. 4 is a bottom view thereof;  
 FIG. 5 is a left side view thereof;  
 FIG. 6 is a right side view thereof;  
 FIG. 7 is a rear view thereof; and,  
 FIG. 8 is a perspective view thereof, the shutter is shown in open condition, the rear view is similar to FIG. 7 except that the middle portion would be an opening.

**1 Claim, 3 Drawing Sheets**

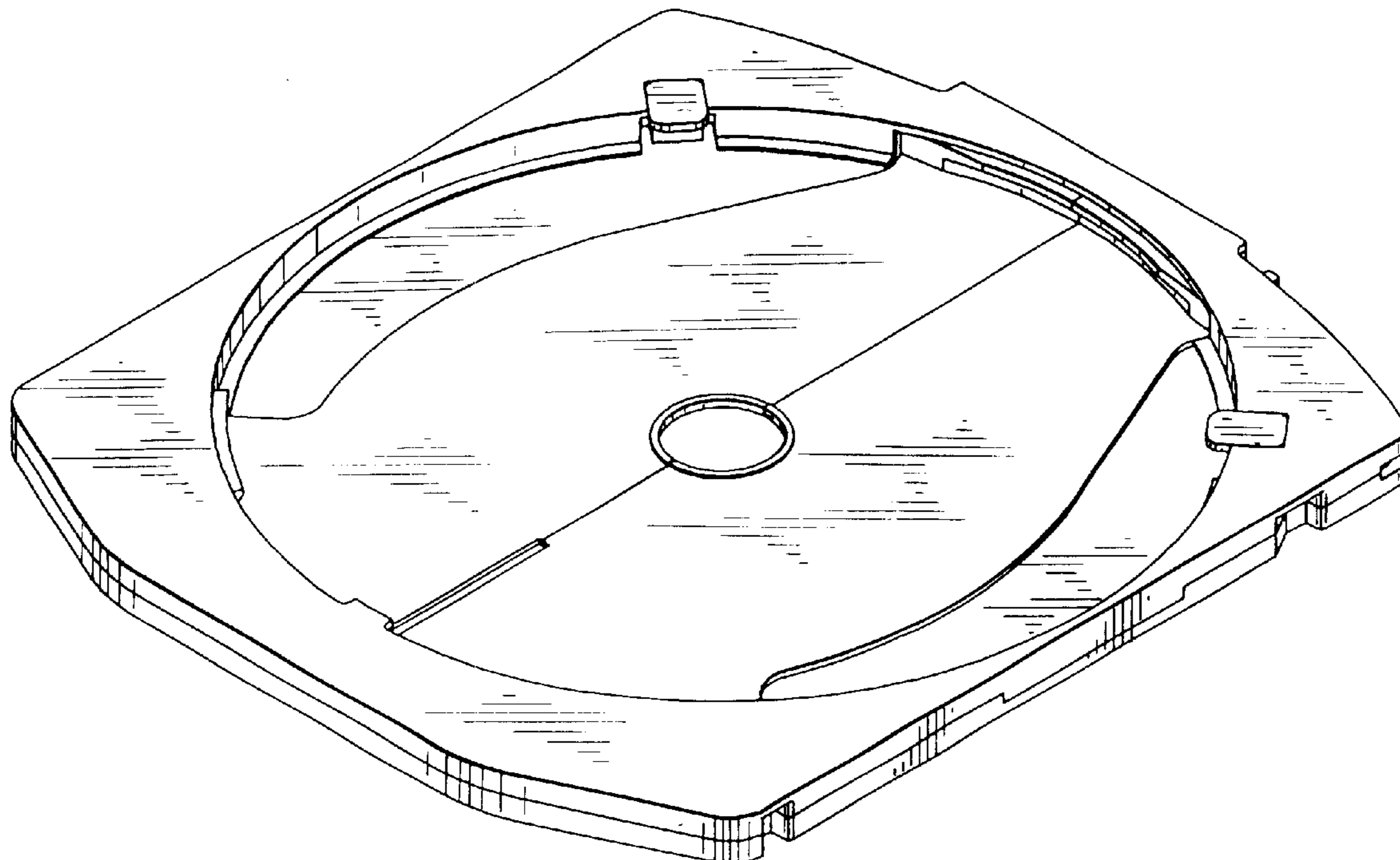

*FIG. 1*

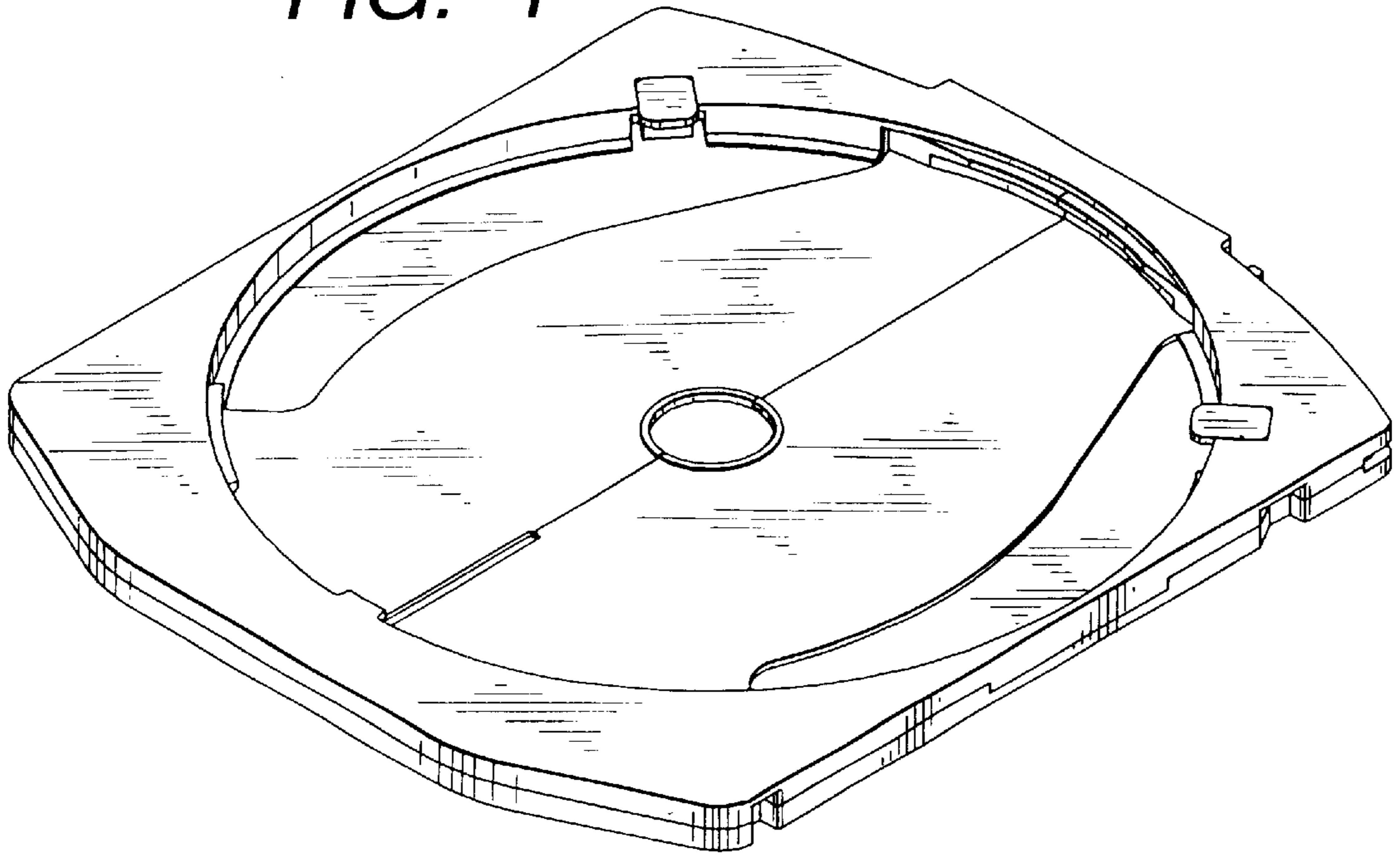

*FIG. 2*

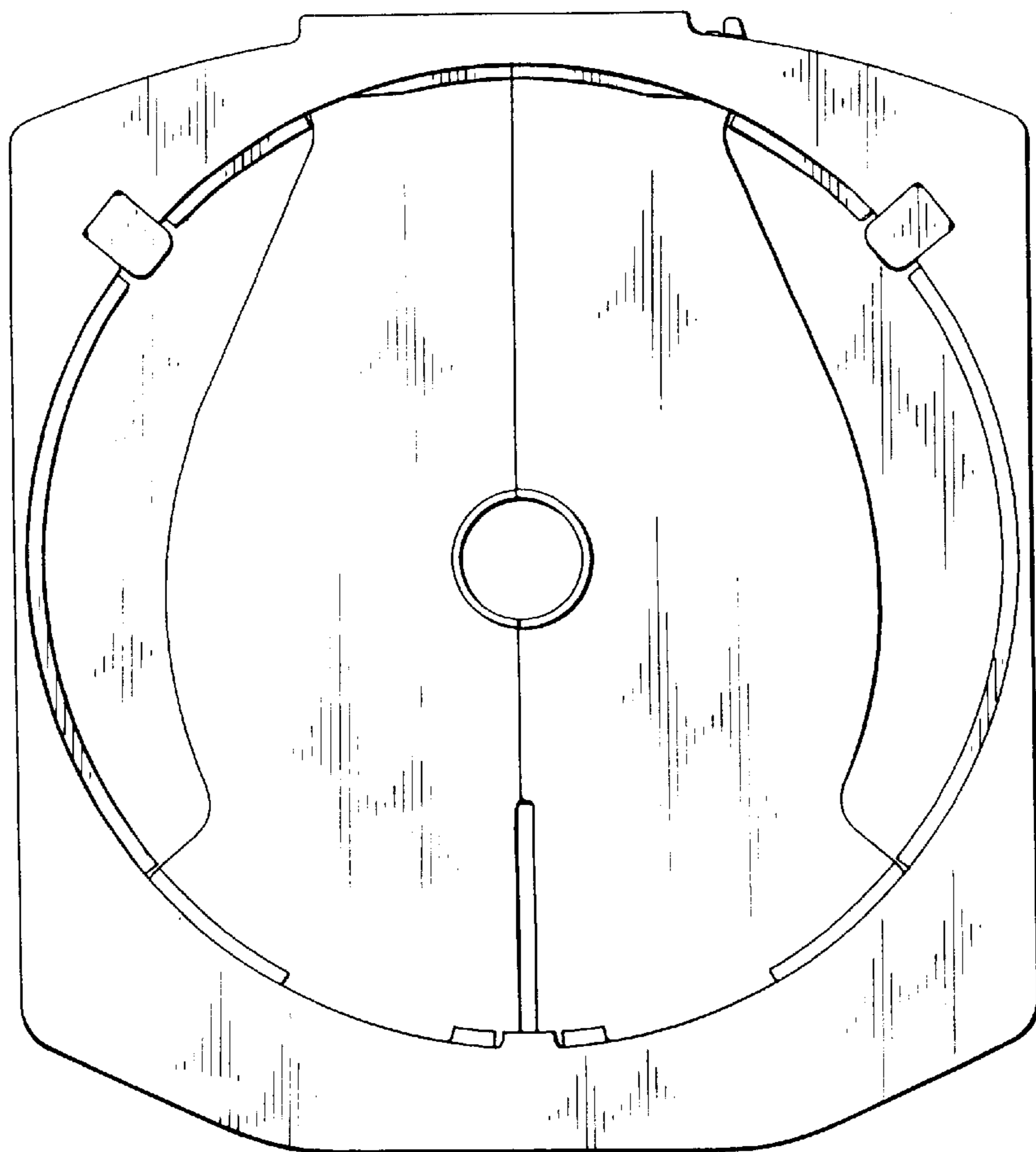

*FIG. 3*

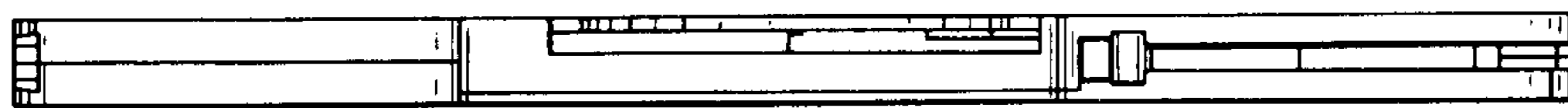

*FIG. 4*

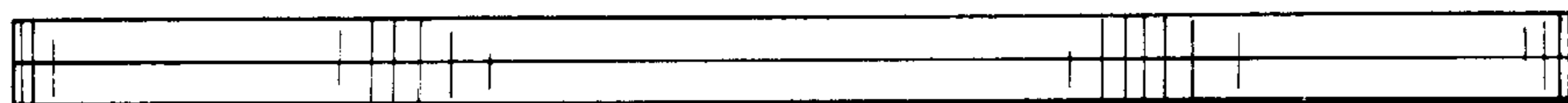

*FIG. 5*

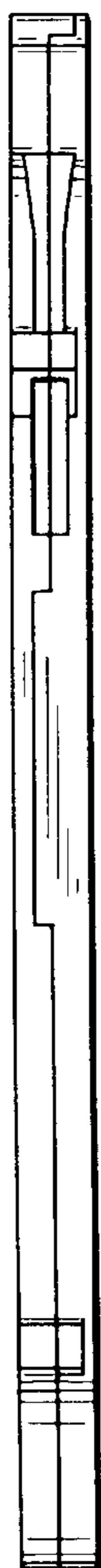

*FIG. 6*



*FIG. 7*

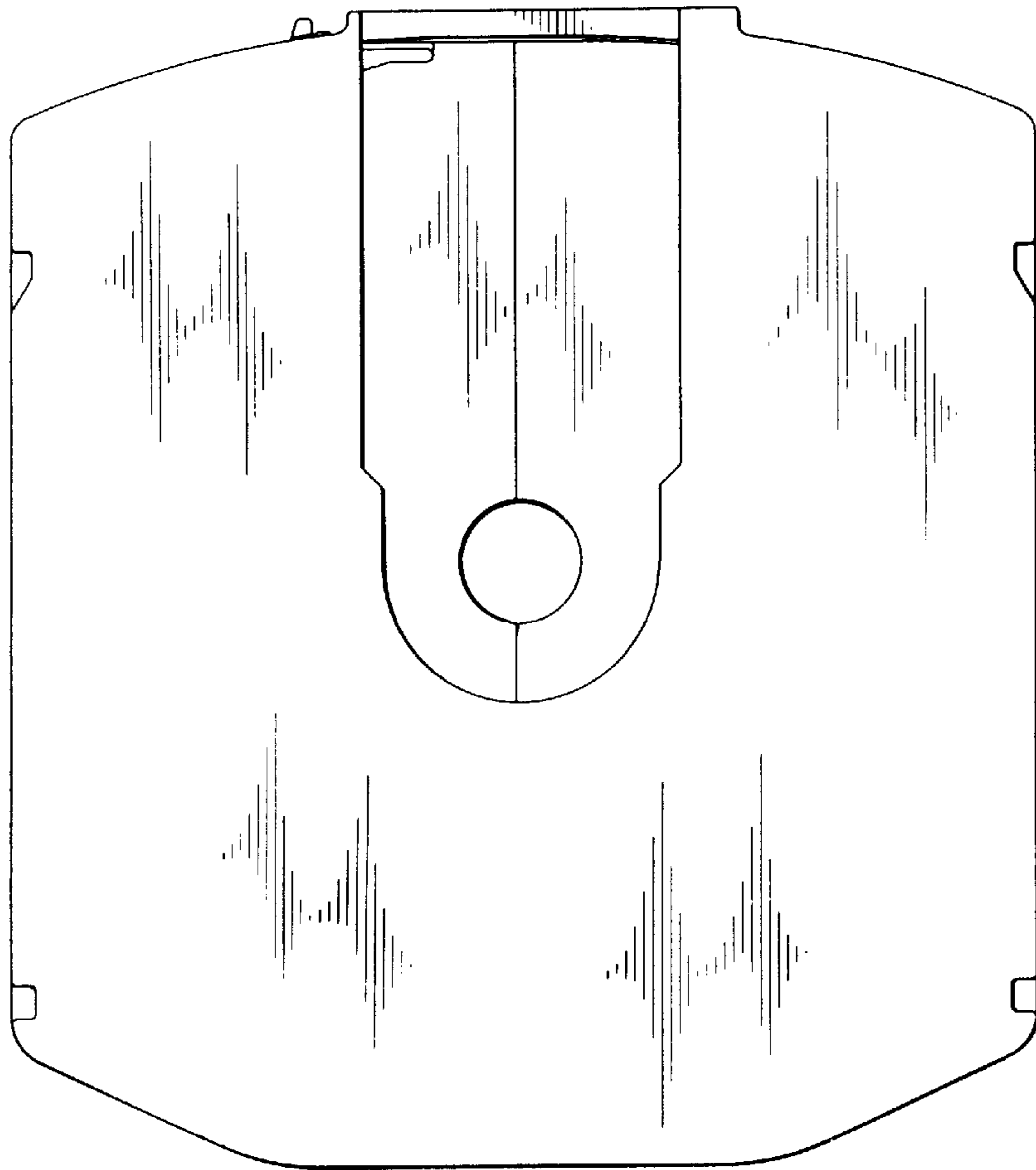

*FIG. 8*

