



US00D468965S

(12) **United States Design Patent**  
**Fino et al.**

(10) **Patent No.:** **US D468,965 S**

(45) **Date of Patent:** **\*\* Jan. 21, 2003**

(54) **OVAL CARVING PLATTER SET**

**DESCRIPTION**

- (75) Inventors: **Nancy E. Fino**, Algonquin, IL (US);  
**Kevin Bradley**, Dundee, IL (US)
- (73) Assignee: **The Pampered Chef, Ltd.**, Addison, IL (US)
- (\*\*) Term: **14 Years**
- (21) Appl. No.: **29/144,723**
- (22) Filed: **Jul. 9, 2001**
- (51) **LOC (7) Cl.** ..... **07-01**
- (52) **U.S. Cl.** ..... **D7/505; D7/587; D7/698; D7/554.2**
- (58) **Field of Search** ..... **D7/500, 505, 545, D7/586, 587, 554.2, 698, 354, 356, 357; 269/13, 15, 289 R; 220/212, 522; 229/401, 125.3**

FIG. 1 is a perspective view of the inventive design showing a platter and a carving insert comprising a set;  
 FIG. 2 is a side elevation view of the design of FIG. 1;  
 FIG. 3 is an opposite side elevation view of the design of FIG. 1;  
 FIG. 4 is a top plan view of the design of FIG. 1;  
 FIG. 5 is a bottom plan view of the design of FIG. 1;  
 FIG. 6 is a front elevation view of the design of FIG. 1;  
 FIG. 7 is a back elevation view of the design of FIG. 1; and  
 FIG. 8 is a longitudinal cross-sectional view of the design of FIG. 1.  
 FIG. 9 is a transverse cross-sectional view of the design of FIG. 1;  
 FIG. 10 is a perspective view of the inventive design showing the platter only;  
 FIG. 11 is a side elevation view of the design of FIG. 10;  
 FIG. 12 is an opposite side elevation view of the design of FIG. 10;  
 FIG. 13 is a top plan view of the design of FIG. 10;  
 FIG. 14 is a bottom plan view of the design of FIG. 10;  
 FIG. 15 is a front elevation view of the design of FIG. 10;  
 FIG. 16 is a back elevation view of the design of FIG. 10;  
 FIG. 17 is a longitudinal cross-sectional view of the design of FIG. 10; and,  
 FIG. 18 is a transverse cross-sectional view of the design of FIG. 10;  
 FIG. 19 is a perspective view of the inventive design showing the carving insert only;  
 FIG. 20 is a side elevation view of the design of FIG. 19;  
 FIG. 21 is an opposite side elevation view of the design of FIG. 19;  
 FIG. 22 is a top plan view of the design of FIG. 19;  
 FIG. 23 is a bottom plan view of the design of FIG. 19;  
 FIG. 24 is a front elevation view of the design of FIG. 19;  
 FIG. 25 is a back elevation view of the design of FIG. 19;  
 FIG. 26 is a longitudinal cross-sectional view of the design of FIG. 19; and,  
 FIG. 27 is a transverse cross-sectional view of the design of FIG. 19.

(56) **References Cited**

**U.S. PATENT DOCUMENTS**

D118,557 S	*	1/1940	Guild	.....	D7/545
3,863,832 A	*	2/1975	Gordon et al.	.....	229/125.35
D248,357 S	*	7/1978	Daenen	.....	D7/505
D304,277 S	*	10/1989	Wolff et al.	.....	D7/698
5,366,208 A	*	11/1994	Benjamin	.....	269/13
D368,834 S	*	4/1996	Lillelund et al.	.....	D7/698
D373,509 S	*	9/1996	Bormioli	.....	D7/554.2
D412,643 S	*	8/1999	Cornelissen	.....	D7/586
D432,417 S	*	10/2000	McCann	.....	D9/428
D433,878 S	*	11/2000	Joergensen	.....	D7/552.1
D445,632 S	*	7/2001	Bradley	.....	D7/360
D452,118 S	*	12/2001	Benson	.....	D7/586

**OTHER PUBLICATIONS**

VillaWare 1992 catalog, pp. 28, 31.

\* cited by examiner

*Primary Examiner*—M. N. Pandozzi  
(74) *Attorney, Agent, or Firm*—Alzheimer & Gray

(57) **CLAIM**

The ornamental design for an oval carving platter set, as shown.

**1 Claim, 8 Drawing Sheets**

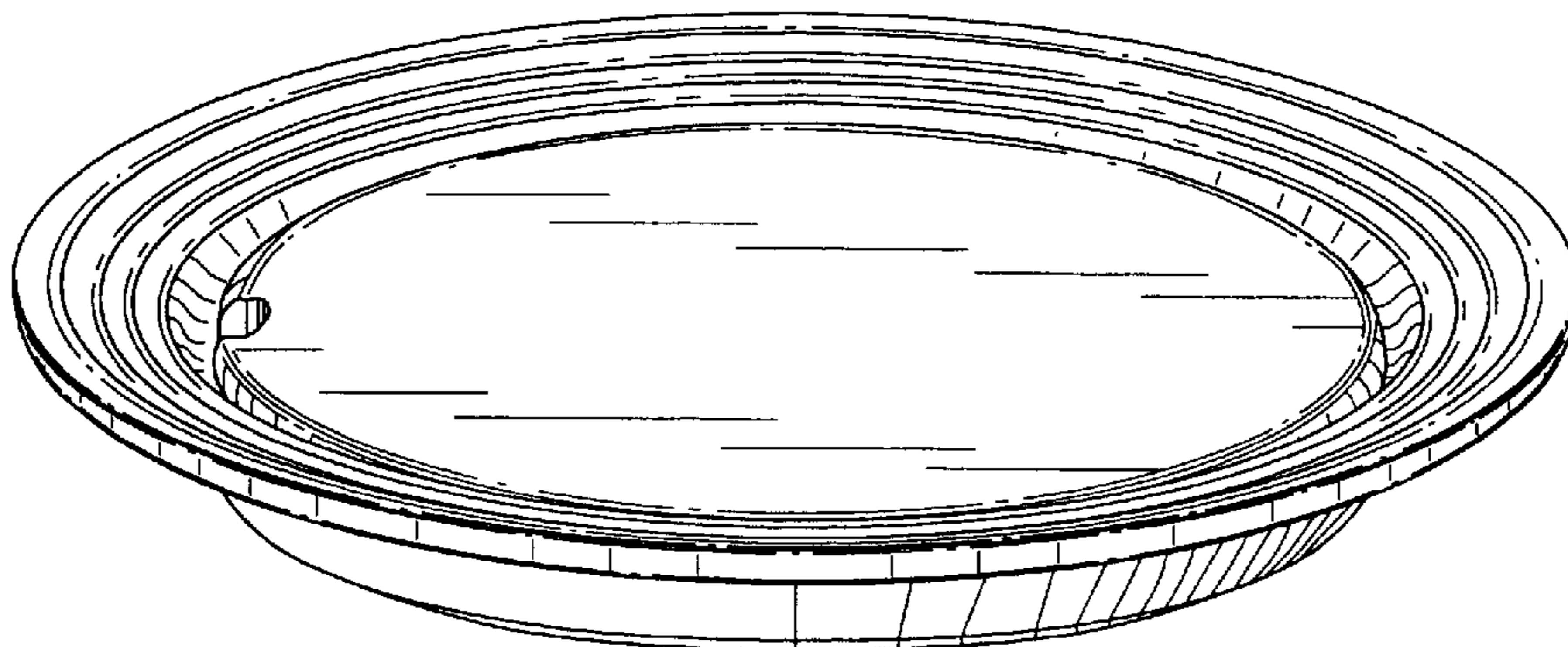

FIG. 1

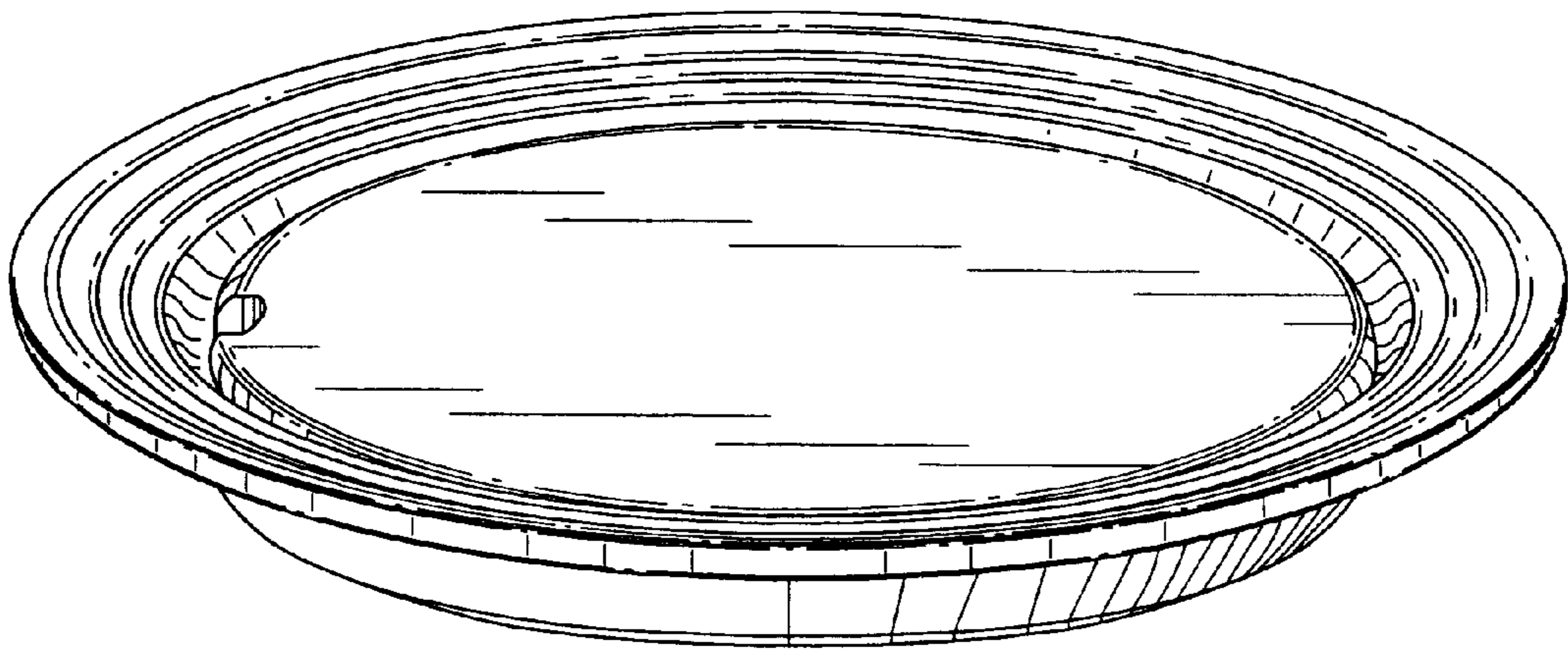

FIG. 2

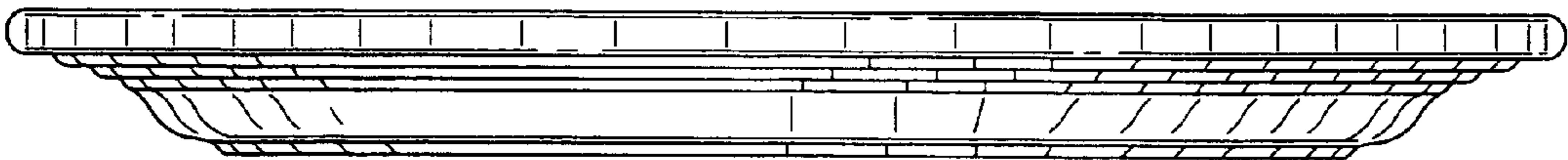
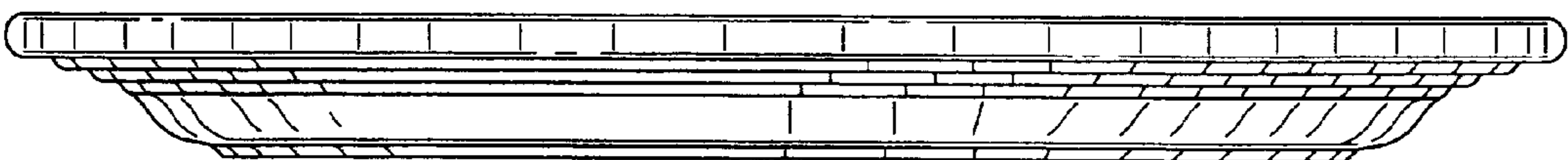

FIG. 3





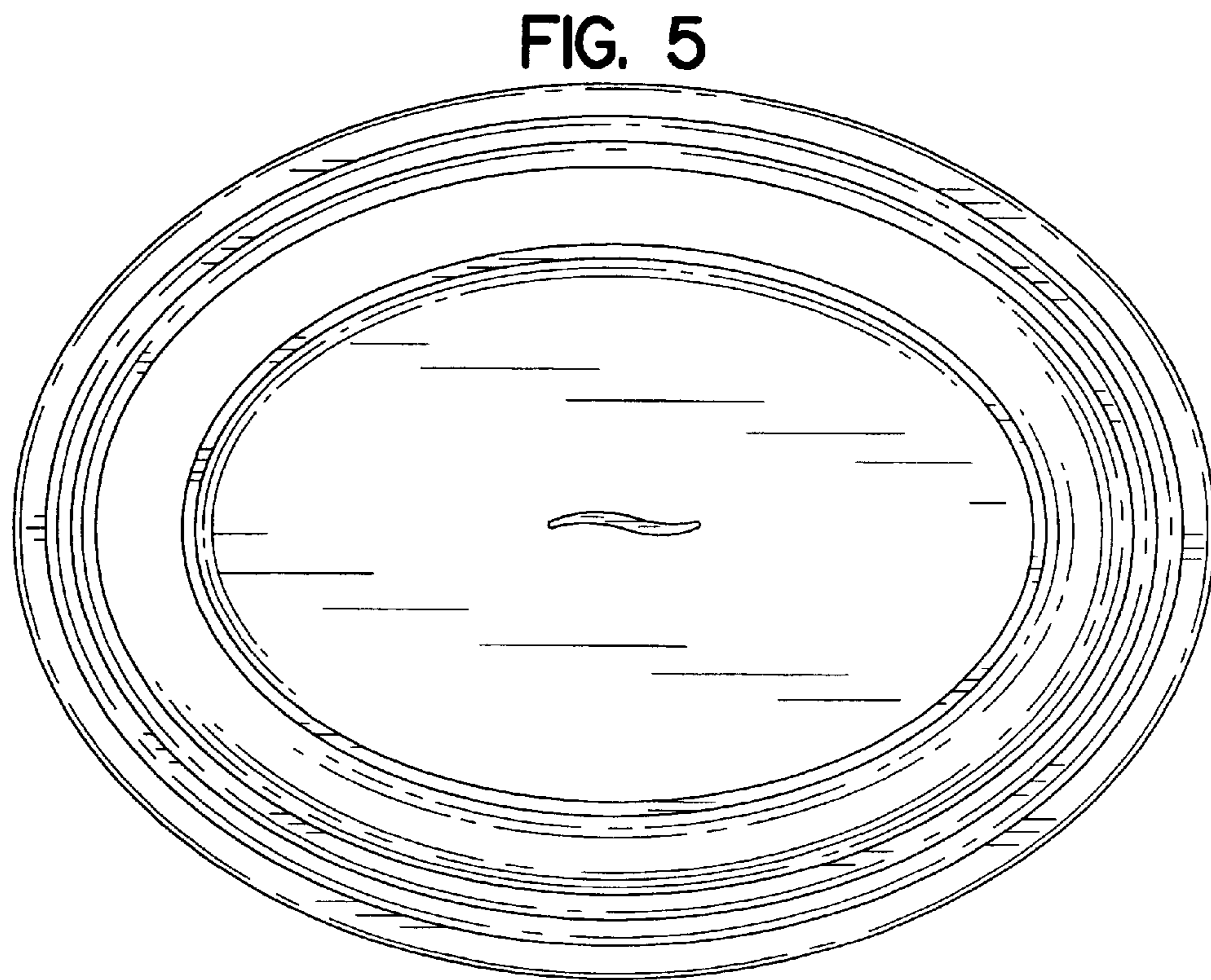
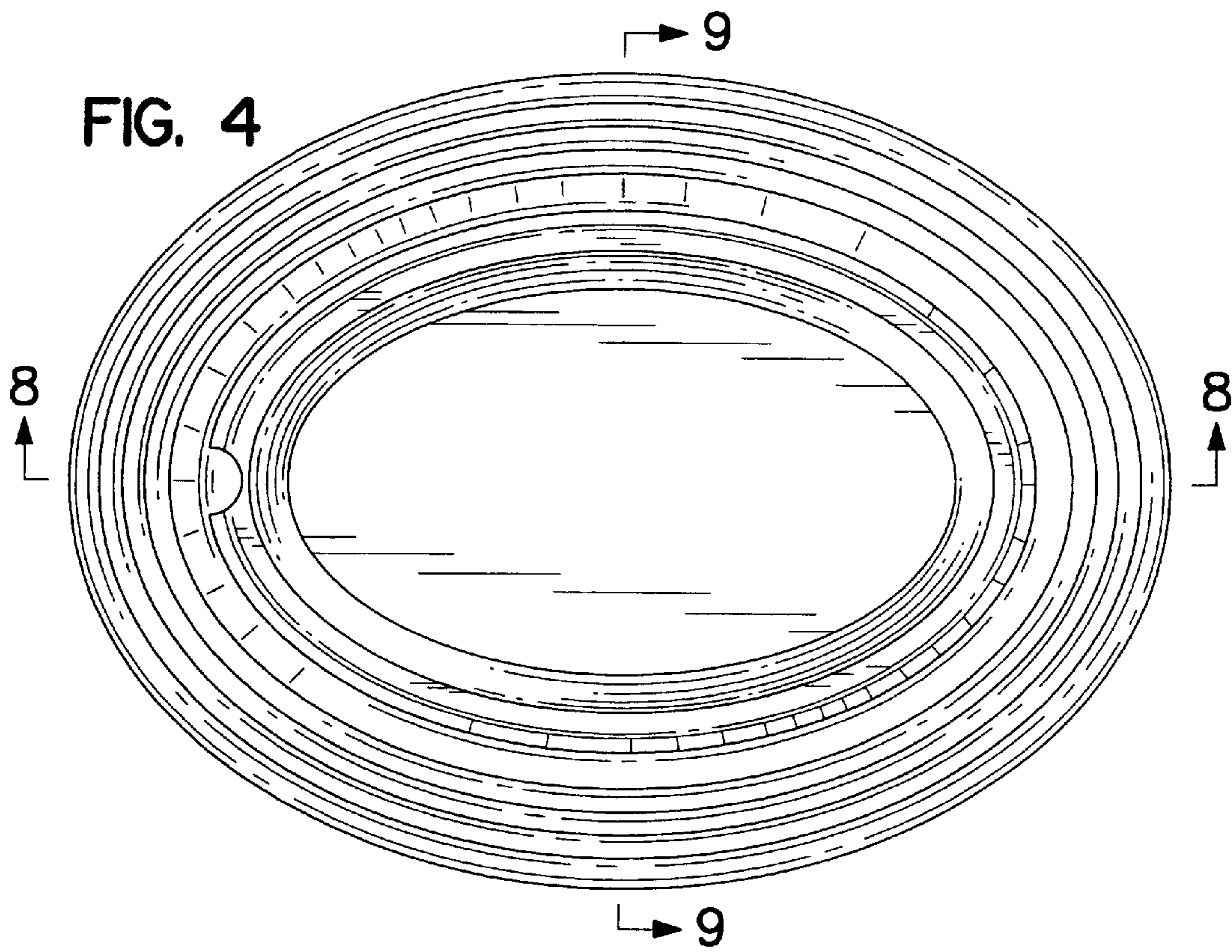

FIG. 6

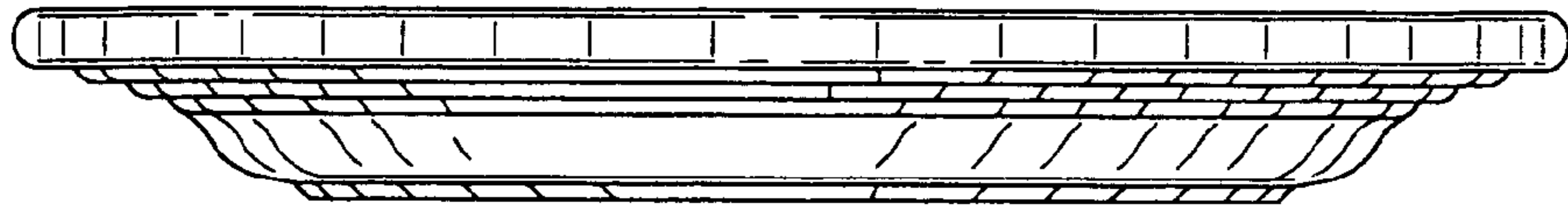

FIG. 7

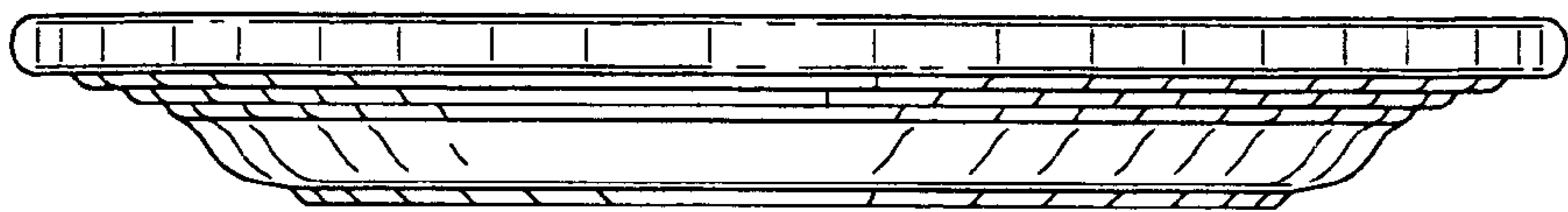

FIG. 8

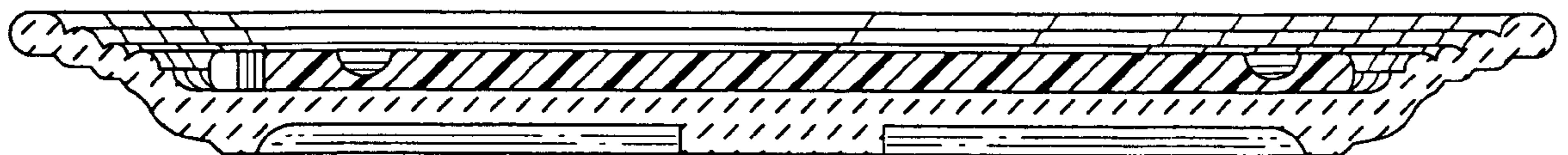

FIG. 9

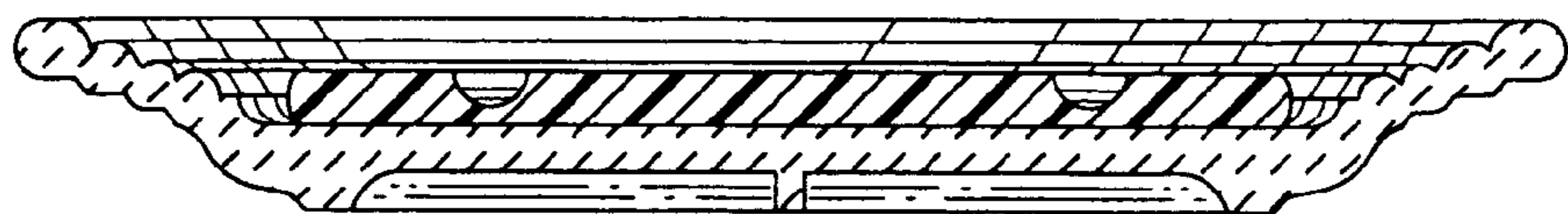

FIG. 10

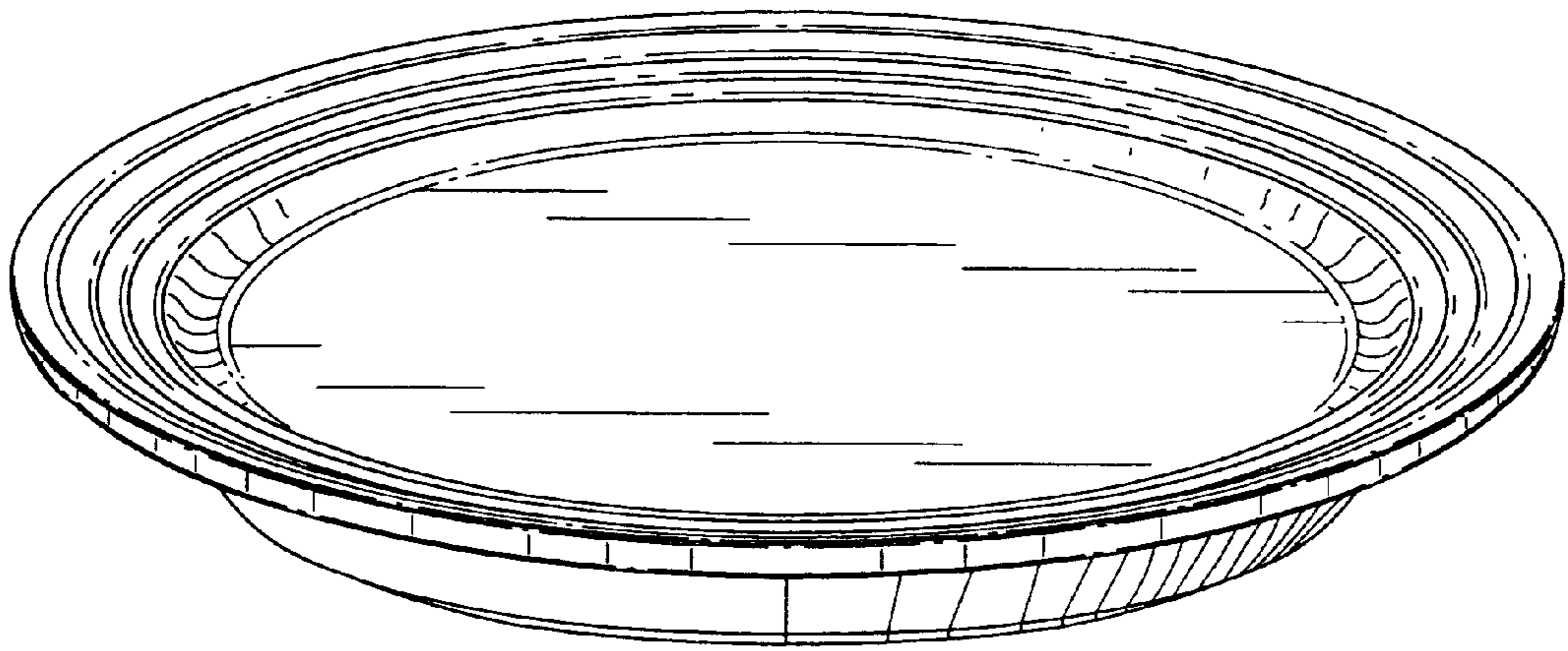

FIG. 11

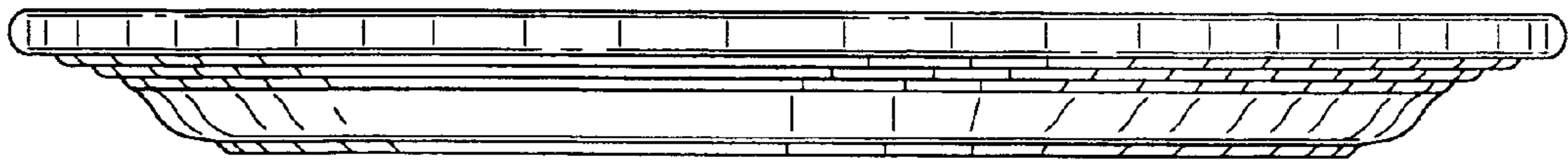
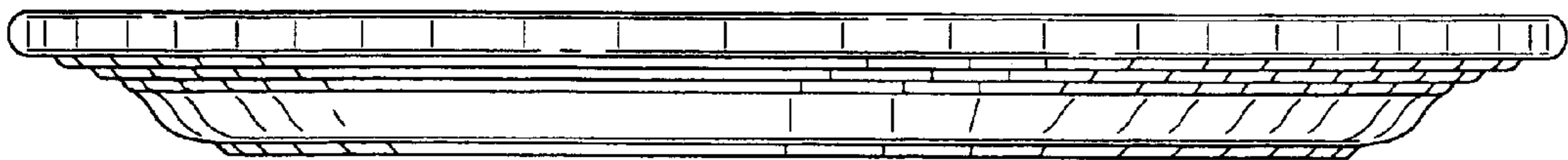

FIG. 12





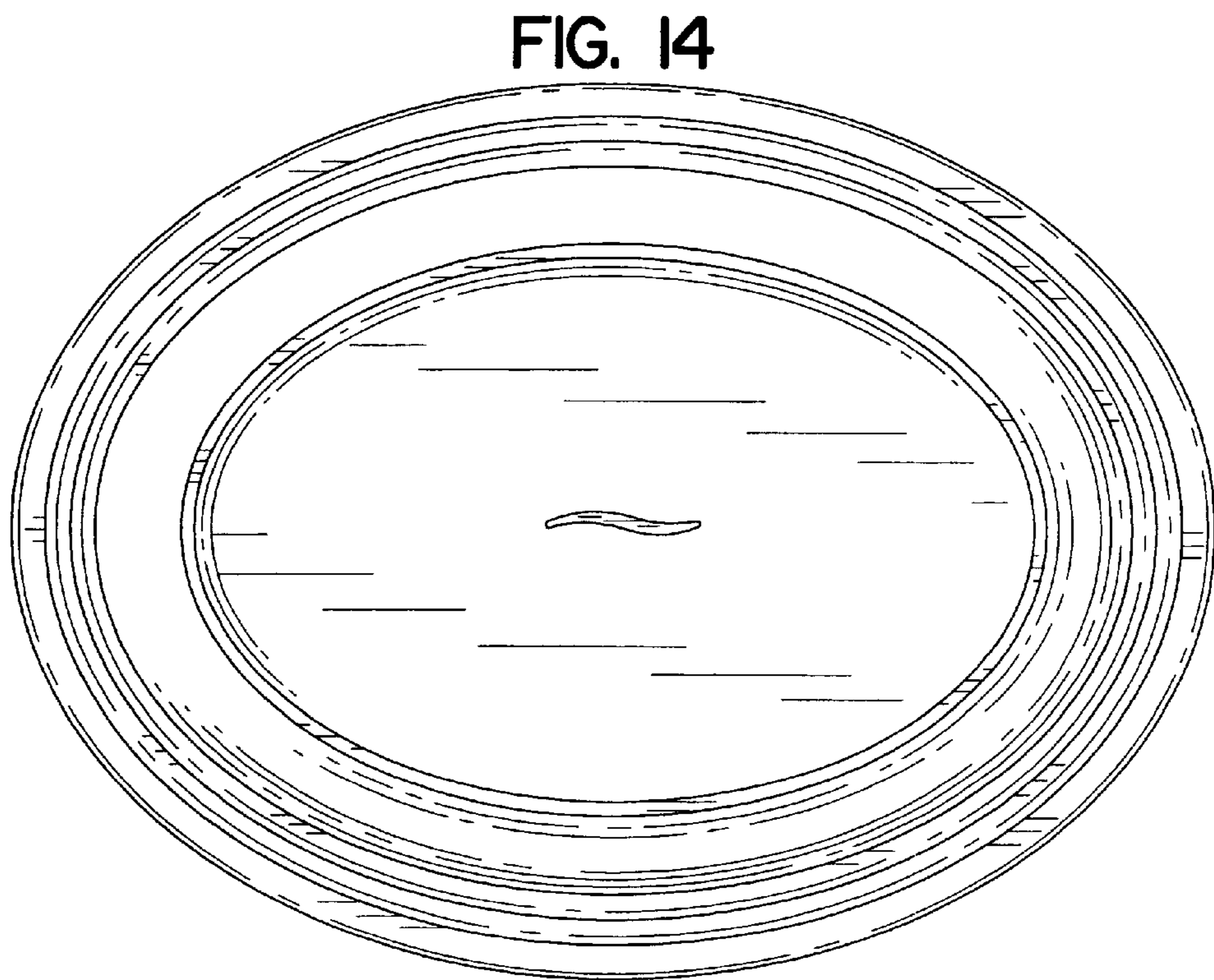
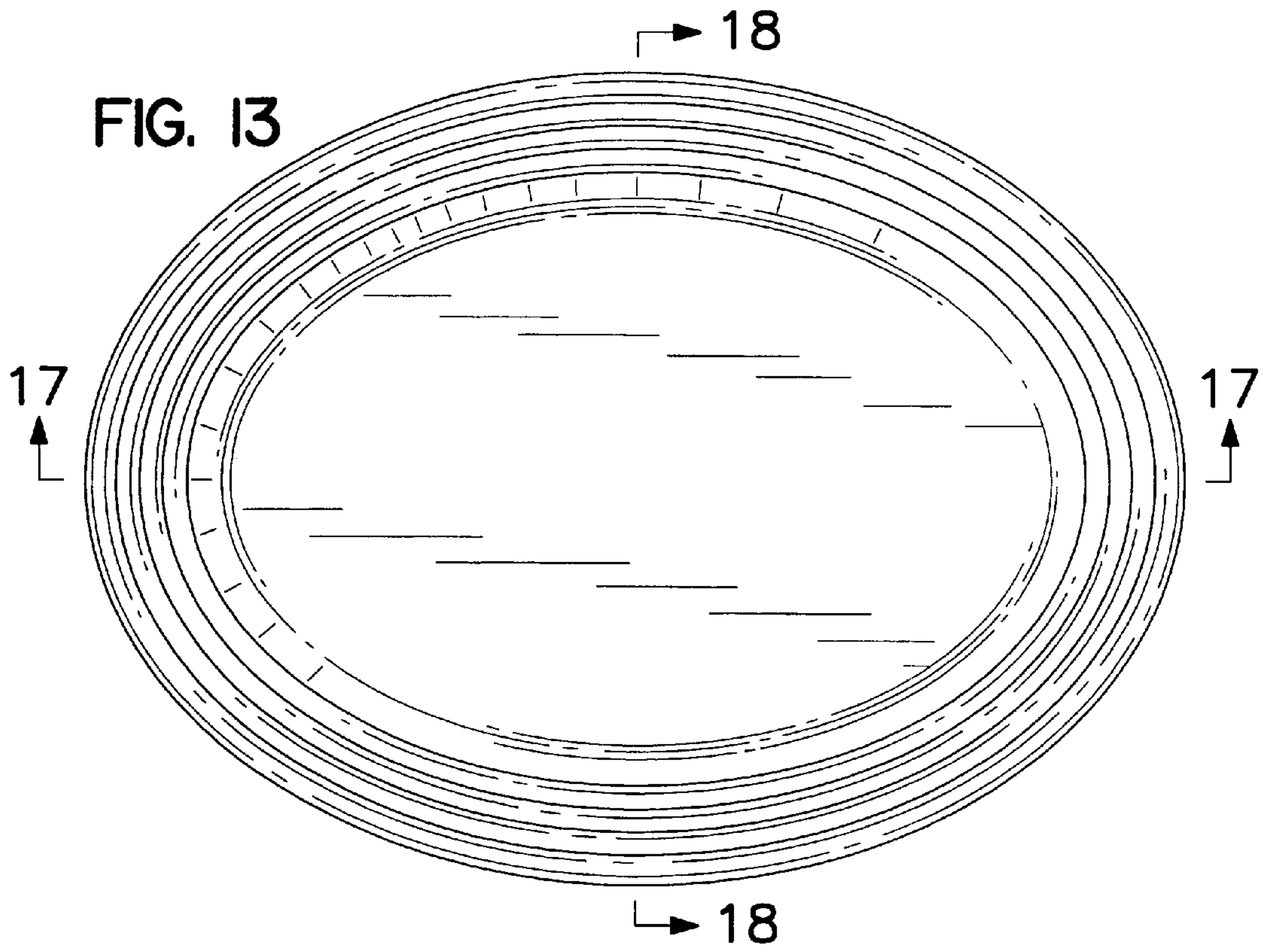

FIG. 15

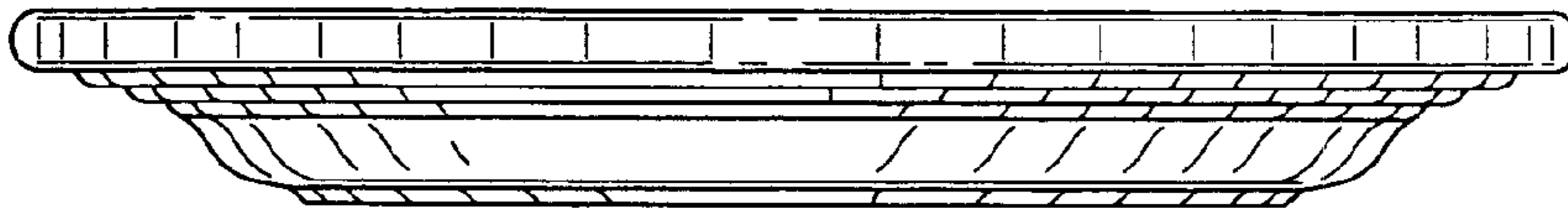

FIG. 16

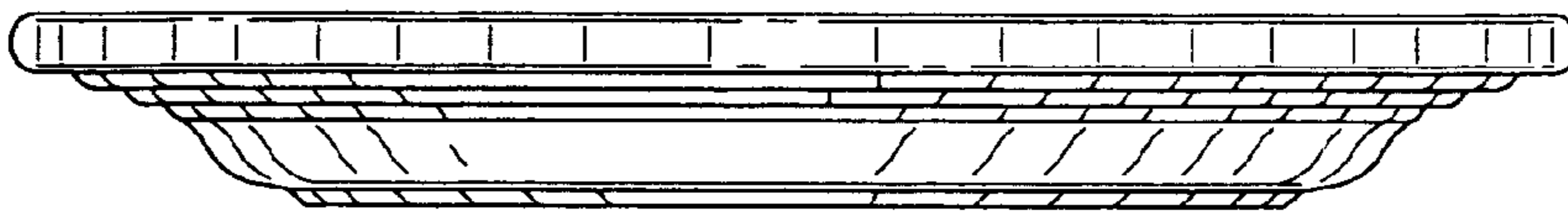

FIG. 17

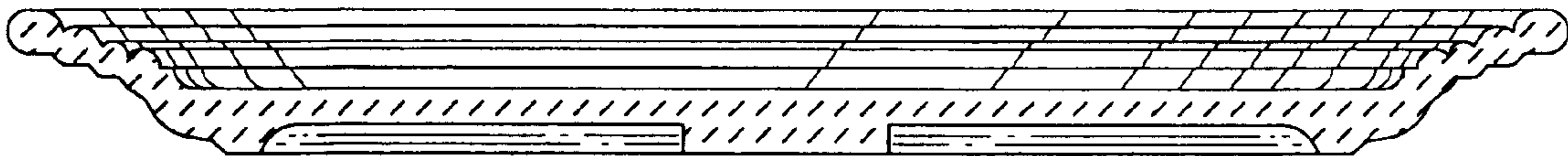

FIG. 18

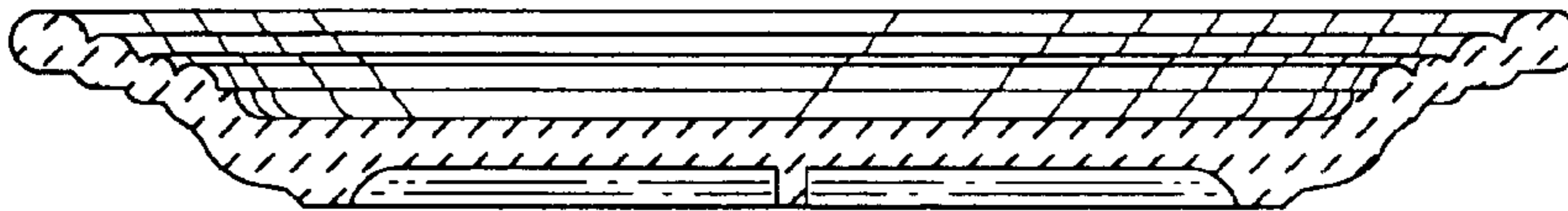

FIG. 19

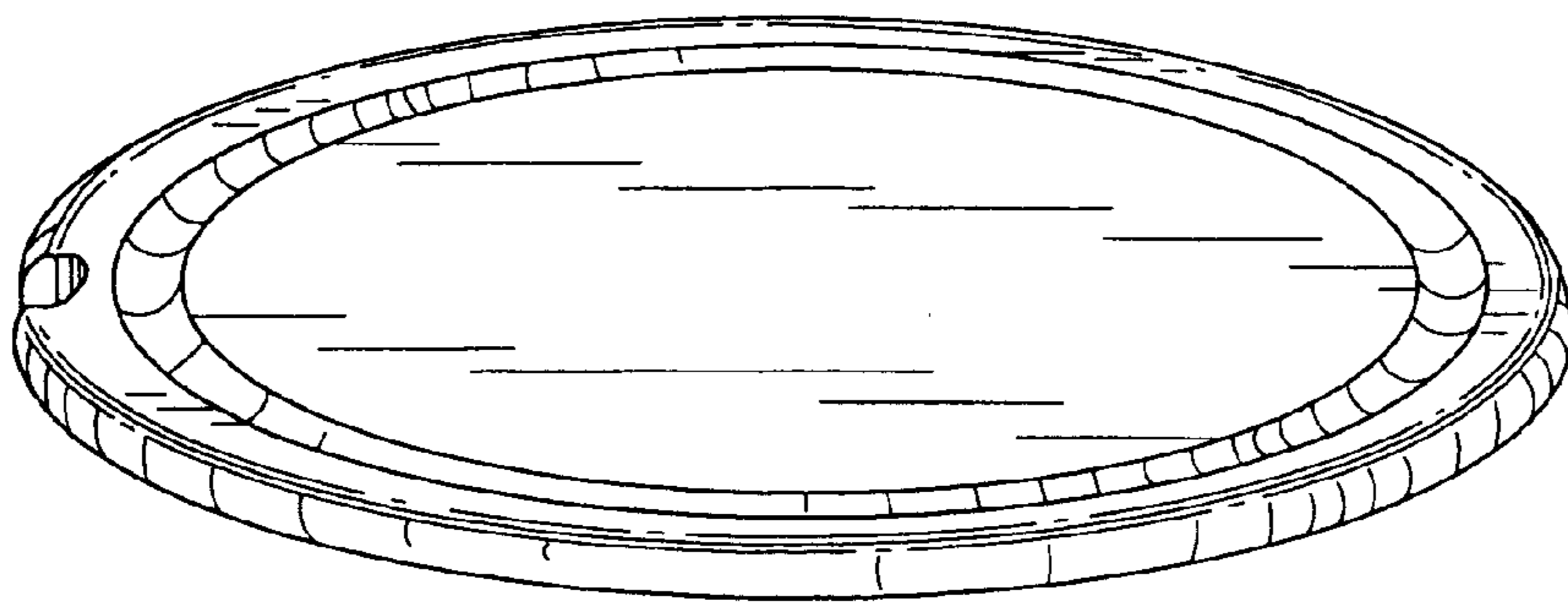

FIG. 20

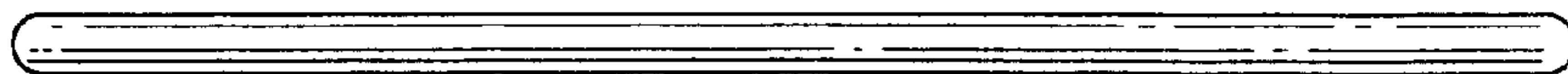

FIG. 21

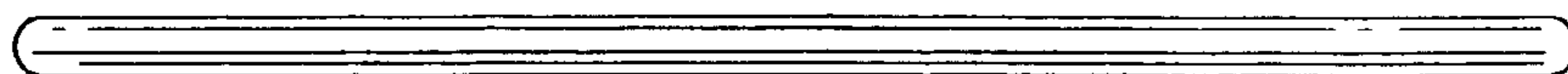

FIG. 22

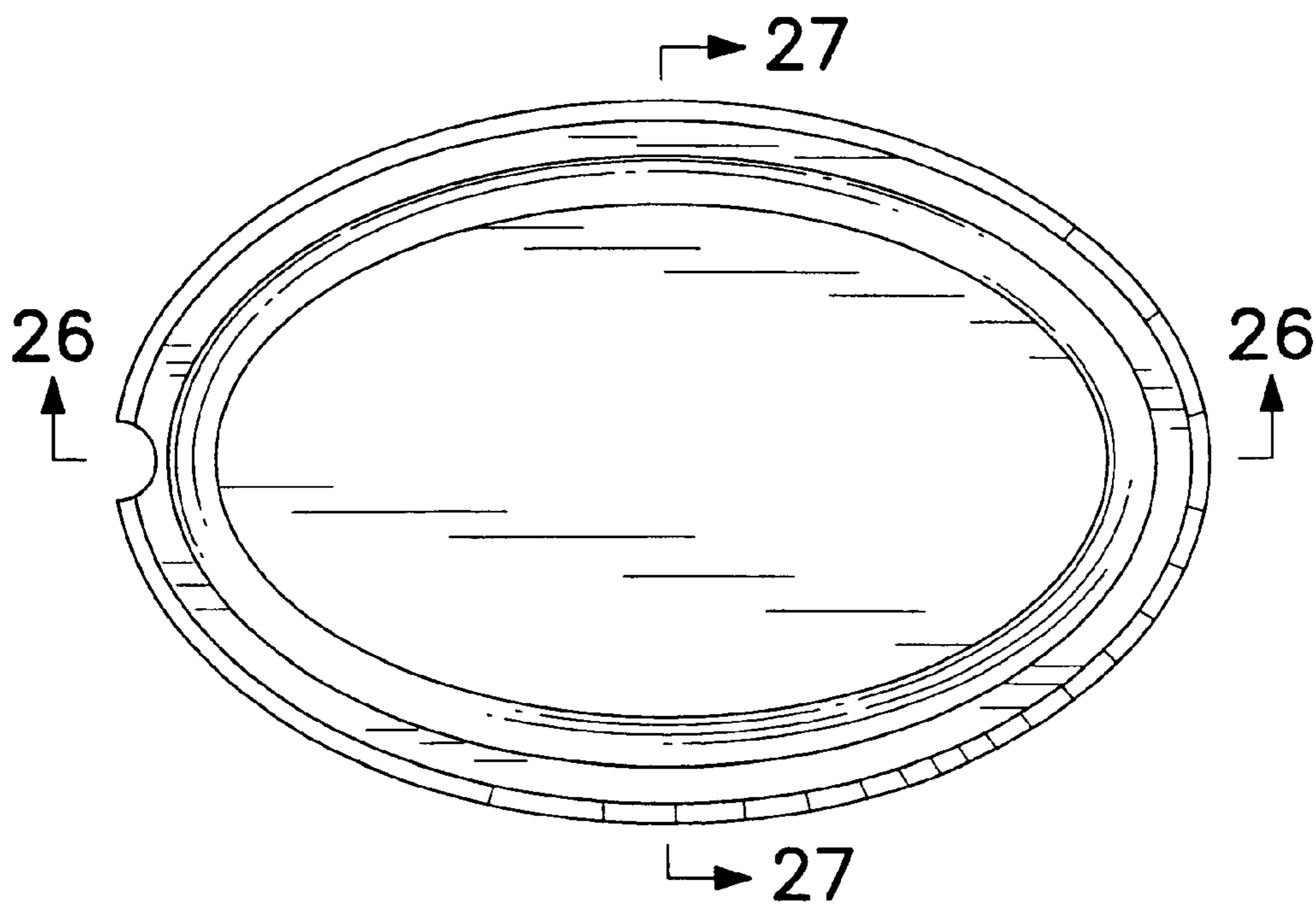



FIG. 23

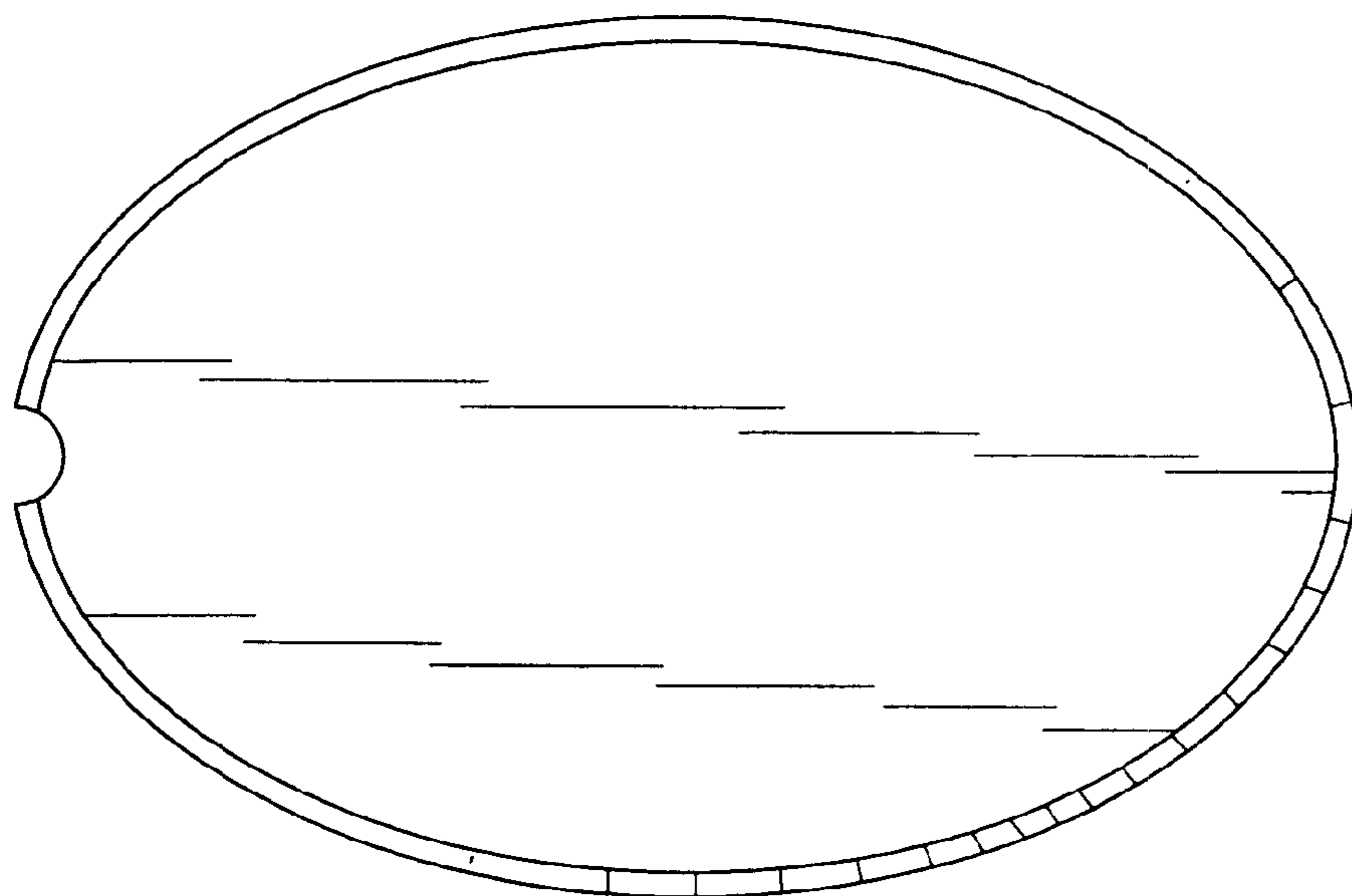

FIG. 24



FIG. 25

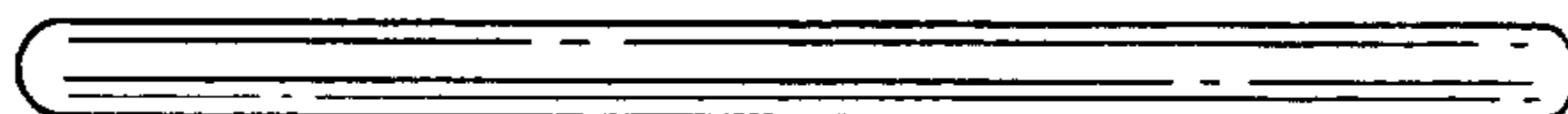

FIG. 26



FIG. 27

