



US00D468918S

(12) **United States Design Patent**  
**de Blois**

(10) **Patent No.:** **US D468,918 S**

(45) **Date of Patent:** **\*\* Jan. 21, 2003**

(54) **STOOL**

(75) Inventor: **Martin de Blois**, Chicago, IL (US)

(73) Assignee: **Baronet, Inc.** (CA)

(\*\*) Term: **14 Years**

(21) Appl. No.: **29/159,130**

(22) Filed: **Apr. 15, 2002**

(51) **LOC (7) Cl.** ..... **06-01**

(52) **U.S. Cl.** ..... **D6/360; D6/375**

(58) **Field of Search** ..... **D6/334, 339, 360,**  
**D6/374, 375, 380, 500, 501, 502; 297/445.1,**  
**446.1, 447.4, 461**

(56) **References Cited**

**U.S. PATENT DOCUMENTS**

D174,927 S	*	6/1955	Shannon	.....	D6/375
D192,731 S	*	5/1962	Gelman	.....	D6/339
D263,775 S	*	4/1982	Hopper	.....	D6/339
D293,743 S	*	1/1988	Hoyt	.....	D6/360
D307,837 S	*	5/1990	Grant	.....	D6/380
D357,592 S	*	4/1995	Kellen	.....	D6/360
D368,379 S	*	4/1996	Muller	.....	D6/360
D400,721 S	*	11/1998	Baeriswyl et al.	.....	D6/360
D431,380 S	*	10/2000	Hutton	.....	D6/360
D460,282 S	*	7/2002	Starck	.....	D6/374

\* cited by examiner

*Primary Examiner*—Gary D. Watson

(74) *Attorney, Agent, or Firm*—SAIDMAN DesignLaw Group

(57) **CLAIM**

The ornamental design for a stool, as shown and described.

**DESCRIPTION**

FIG. 1 is a front perspective view of a stool showing my new design;

FIG. 2 is a side perspective view thereof;

FIG. 3 is a front view thereof;

FIG. 4 is a left side view thereof, said right side view being a mirror image;

FIG. 5 is a front perspective view of a second embodiment showing my new design;

FIG. 6 is a side perspective view thereof;

FIG. 7 is a front view thereof;

FIG. 8 is a left side view thereof, said right side view being a mirror image;

FIG. 9 is a front perspective view of a third embodiment showing my new design;

FIG. 10 is a side perspective view thereof;

FIG. 11 is a front view thereof;

FIG. 12 is a left side view thereof, said right side view being a mirror image;

FIG. 13 is a front perspective view of a fourth embodiment showing my new design;

FIG. 14 is a side perspective view thereof;

FIG. 15 is a front view thereof; and,

FIG. 16 is a left side view thereof, said right side view being a mirror image.

The dashed lines in FIGS. 1-2, 4-6, 8-10, 12-14, and 16 are shown for environmental purposes only and form no part of the claimed design.

**1 Claim, 12 Drawing Sheets**

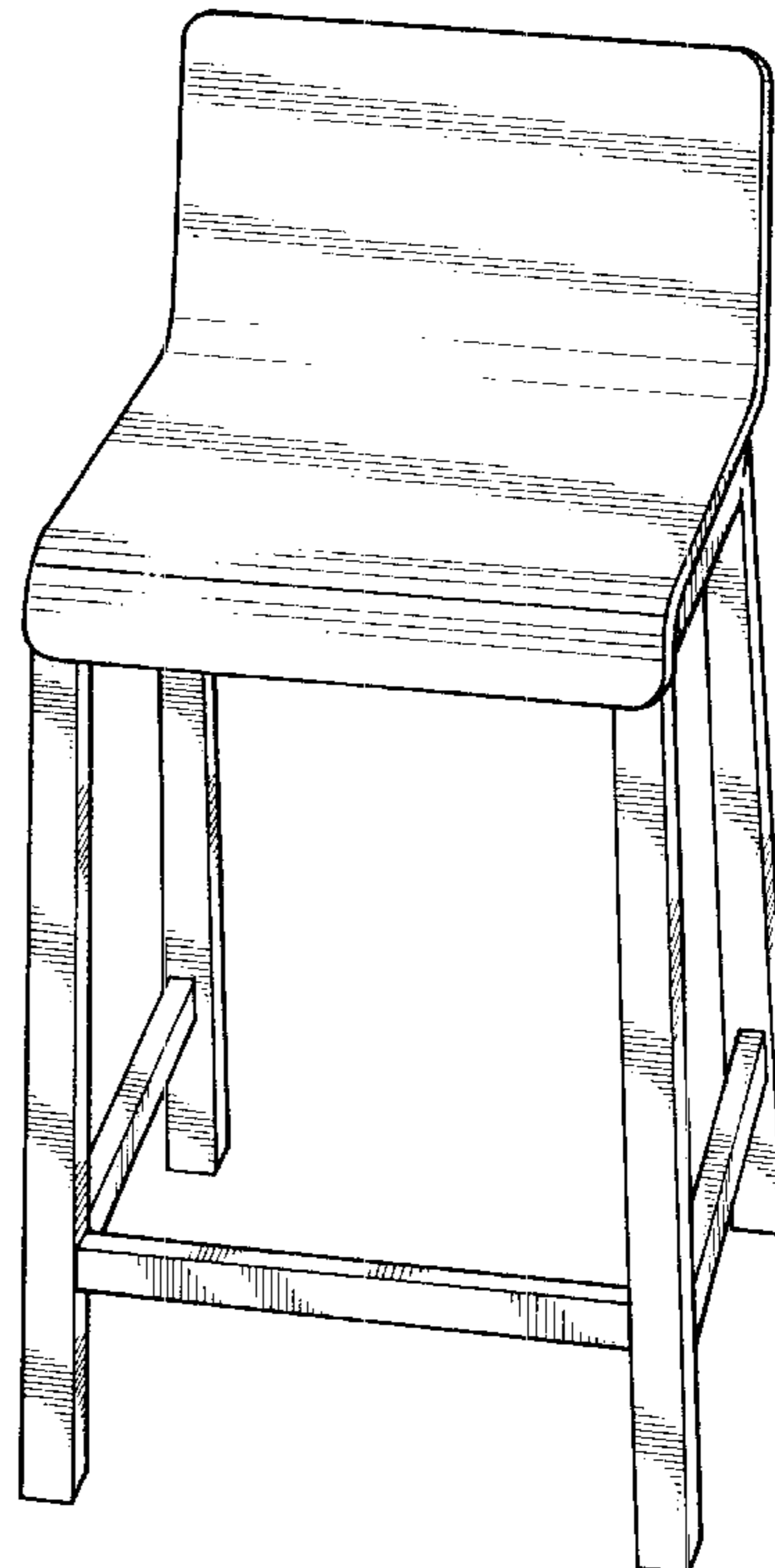
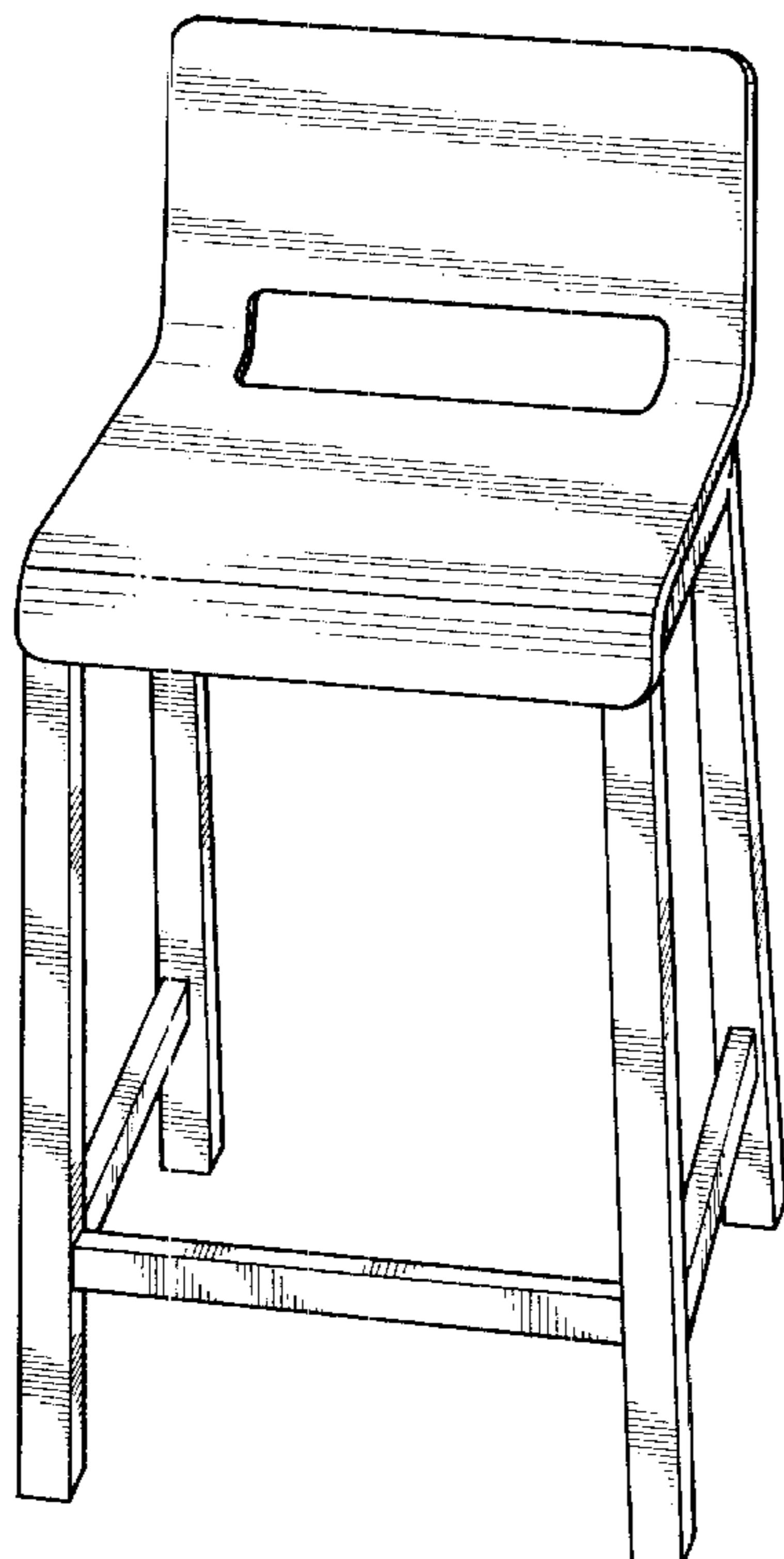

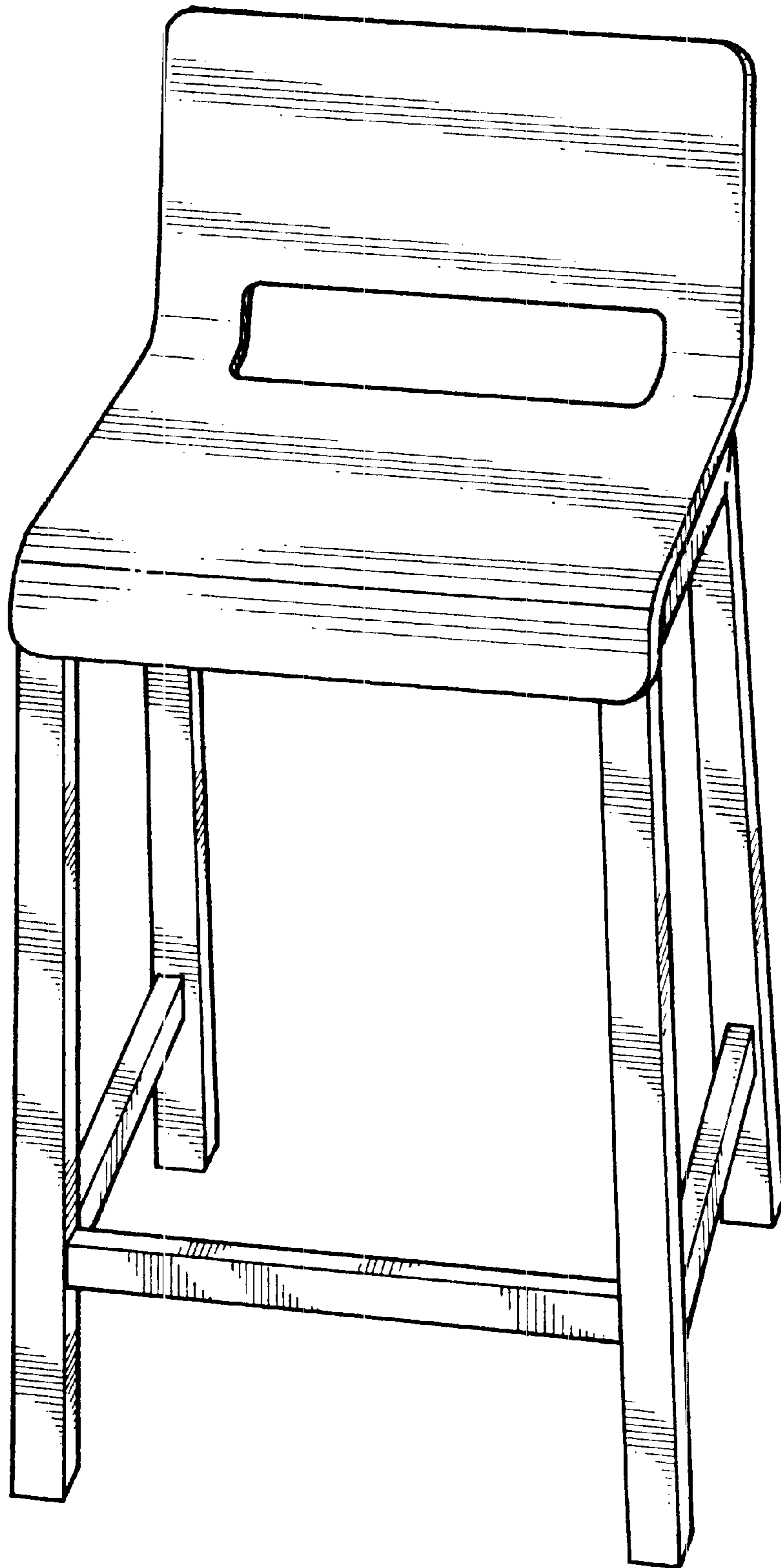
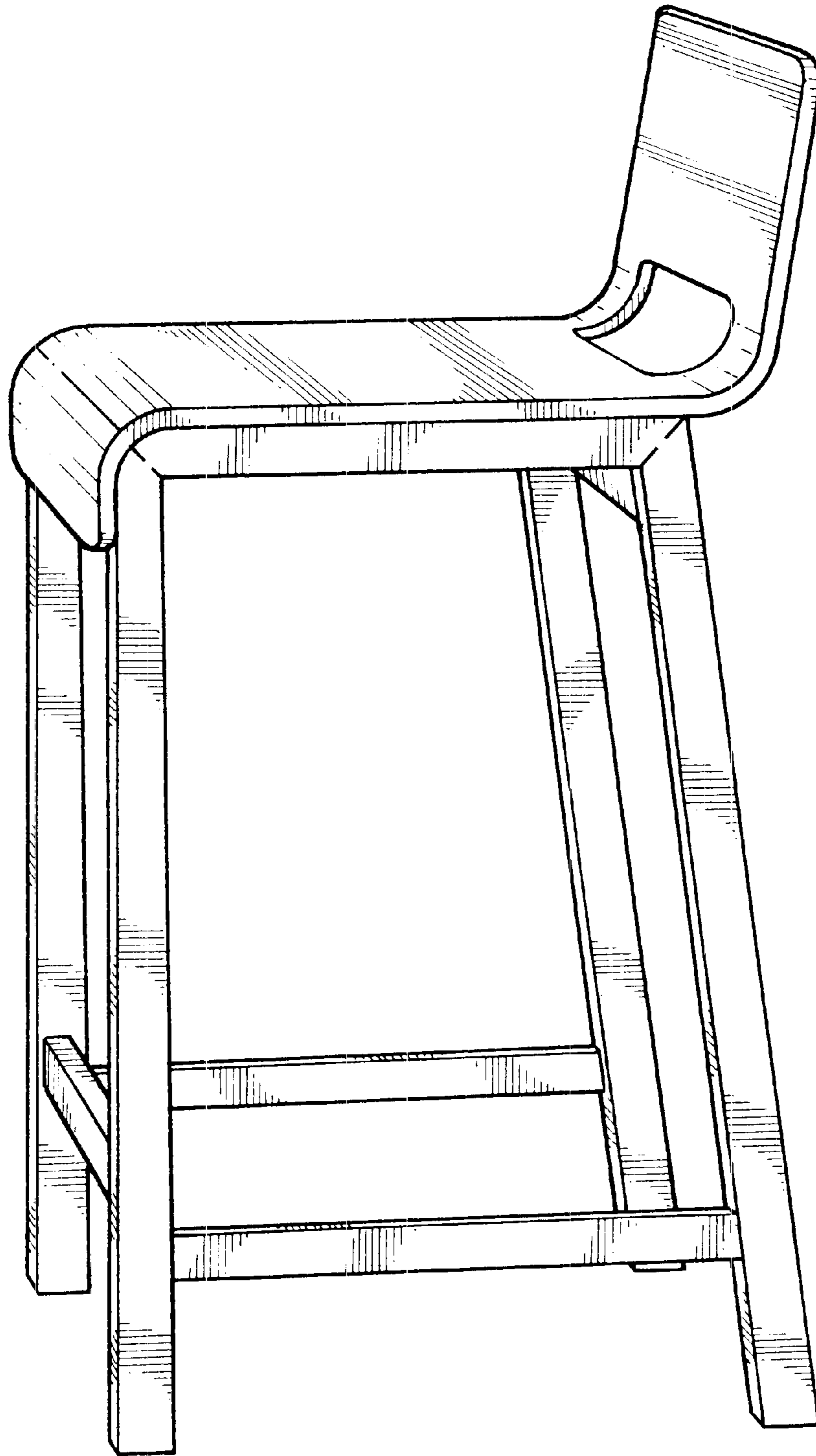

FIG. 1



**FIG.2**

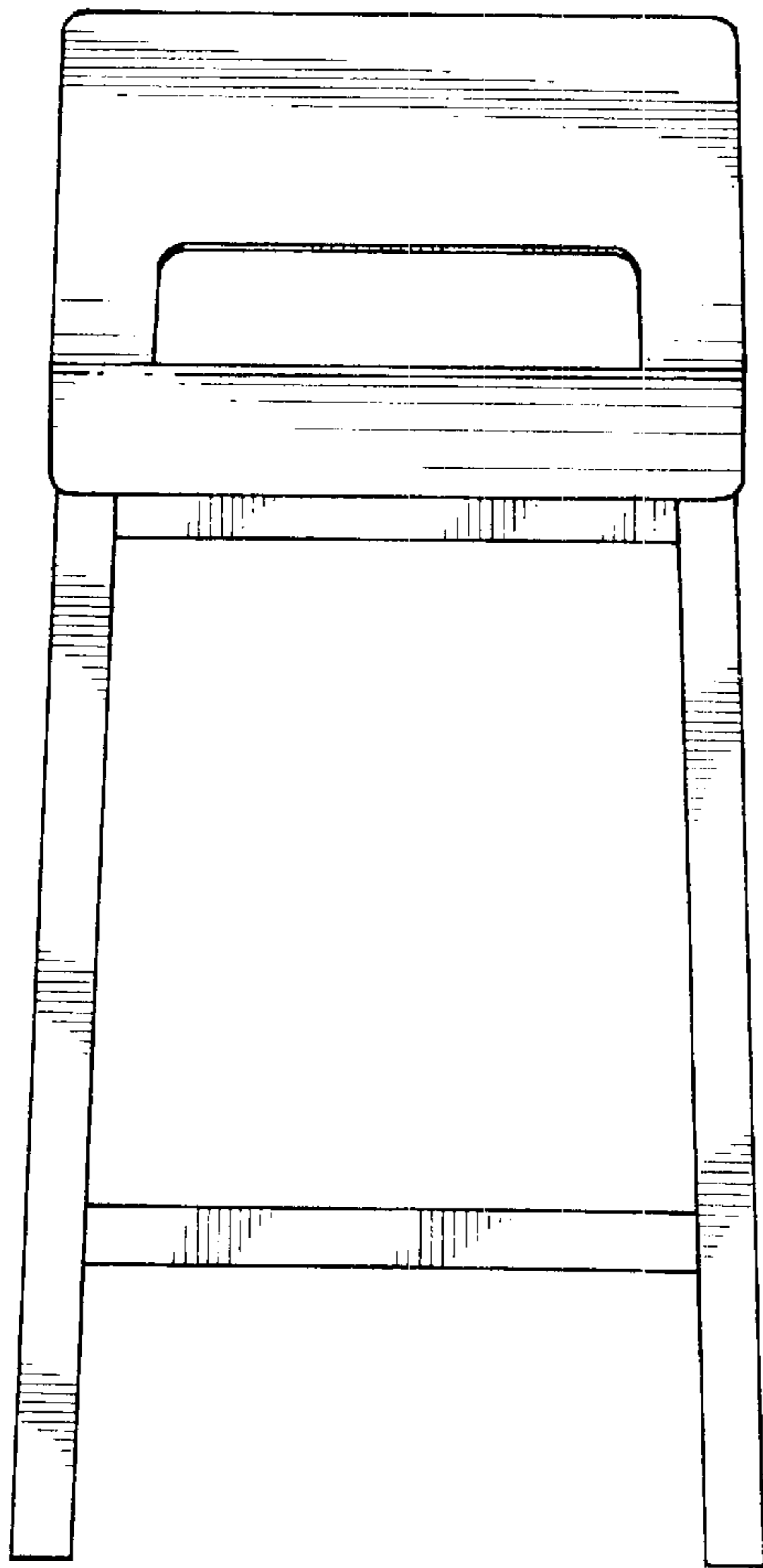

FIG.3

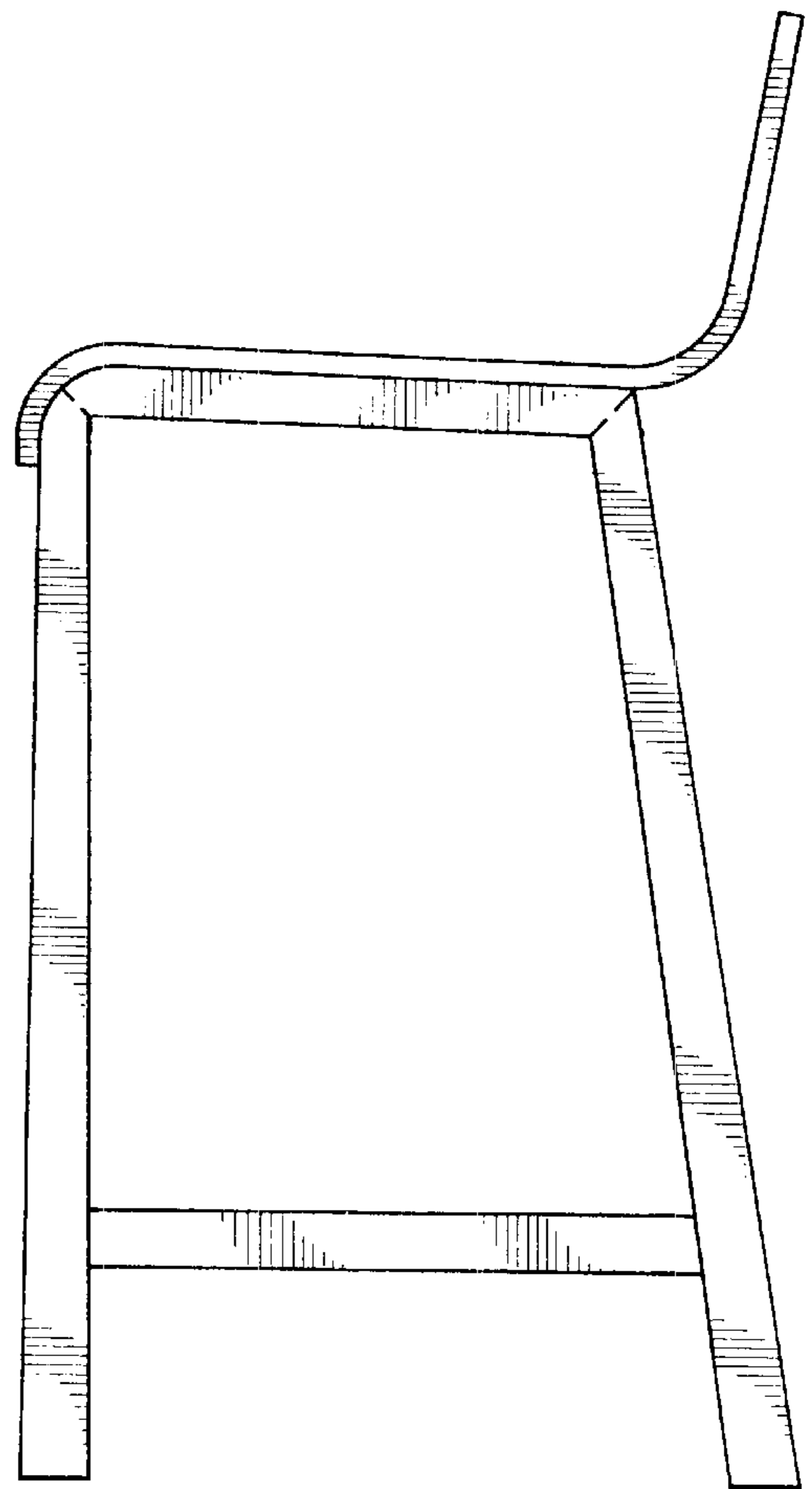
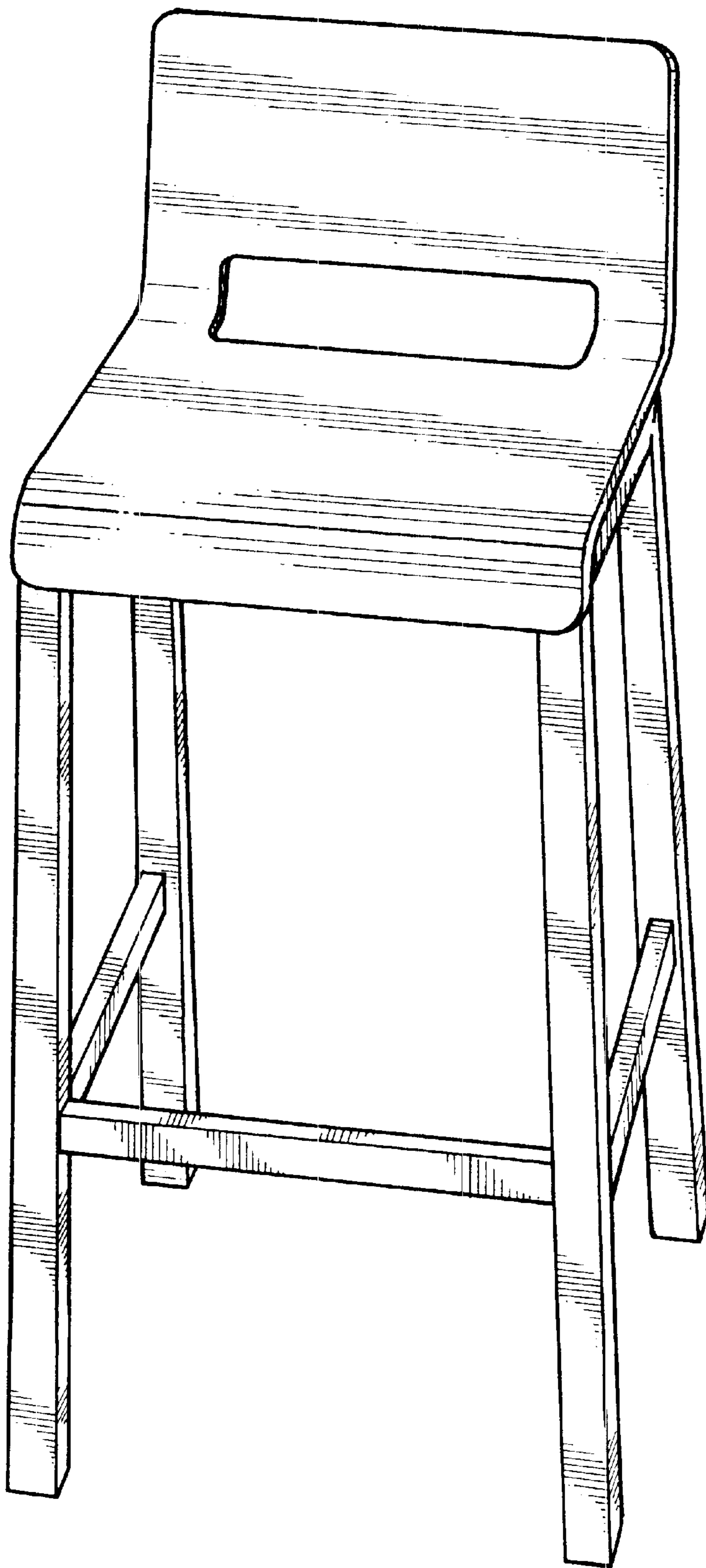
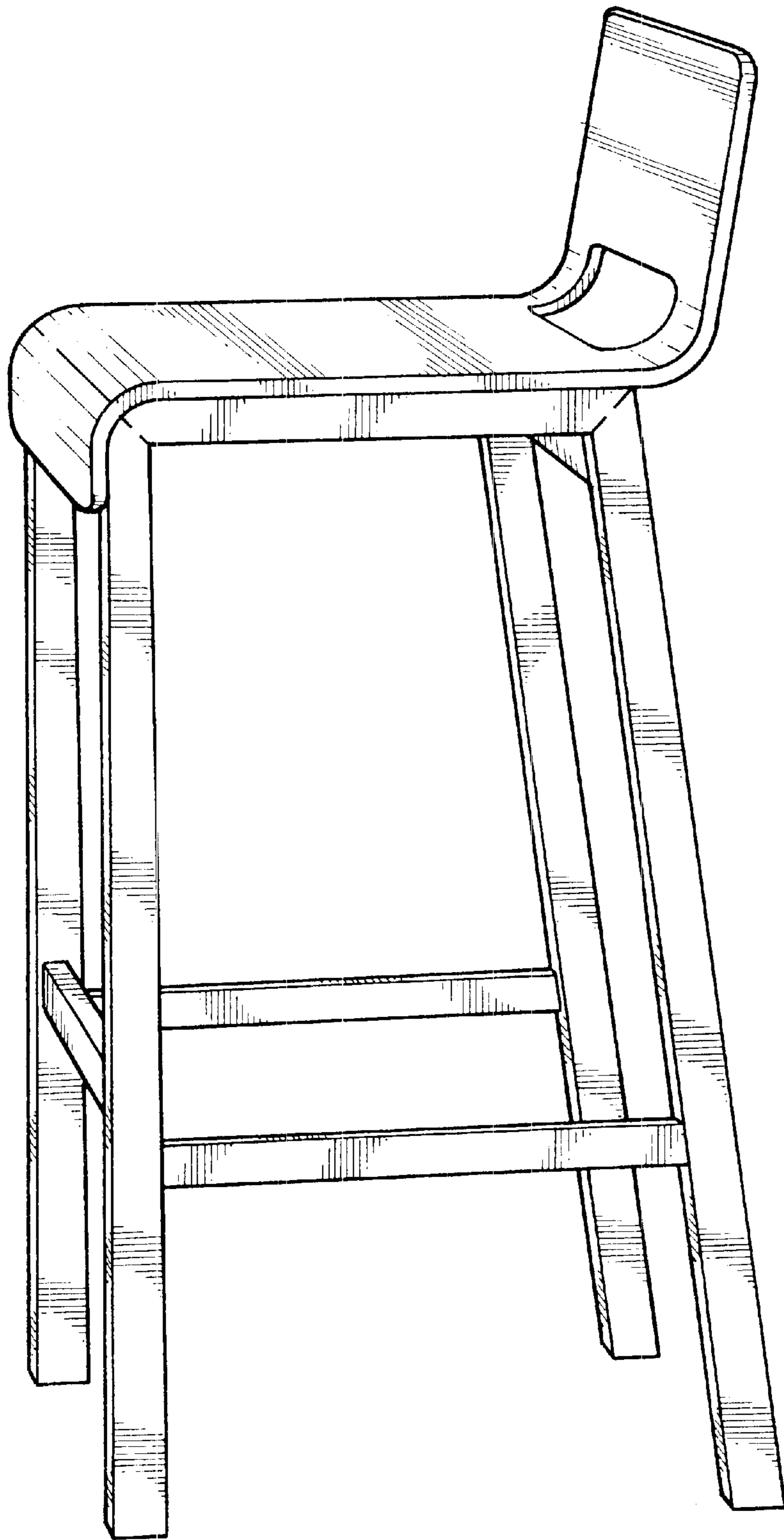

FIG.4



**FIG. 5**



**FIG. 6**

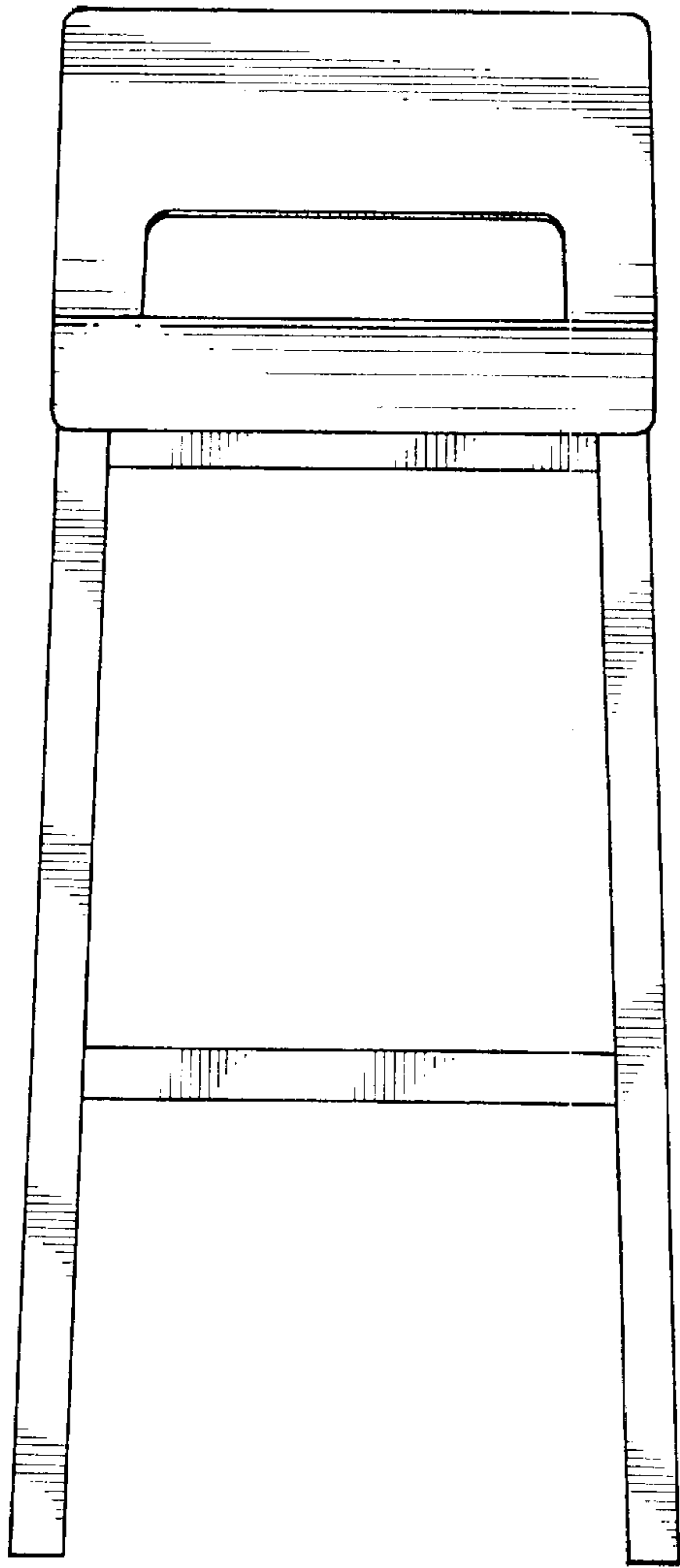

FIG. 7

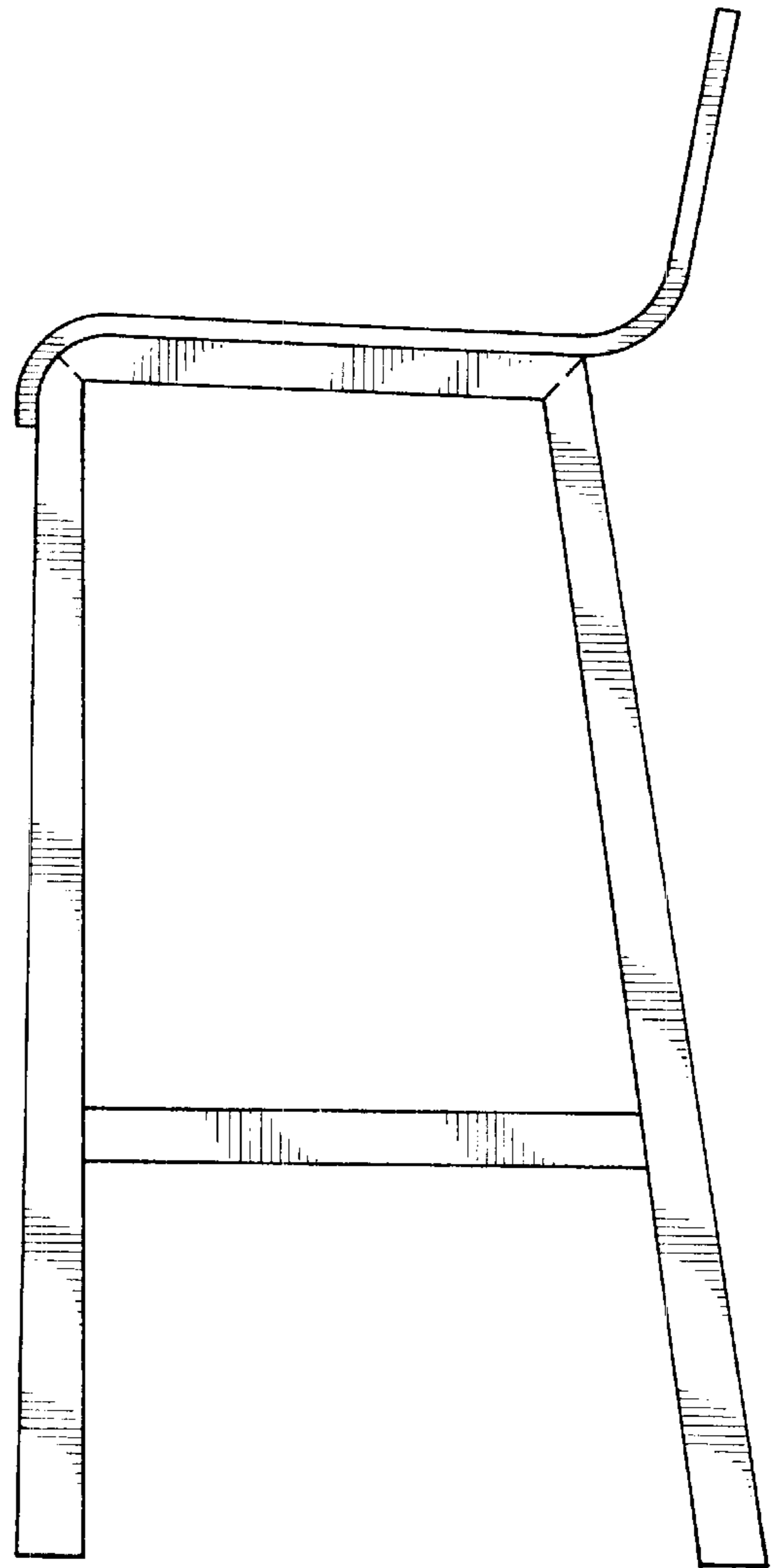
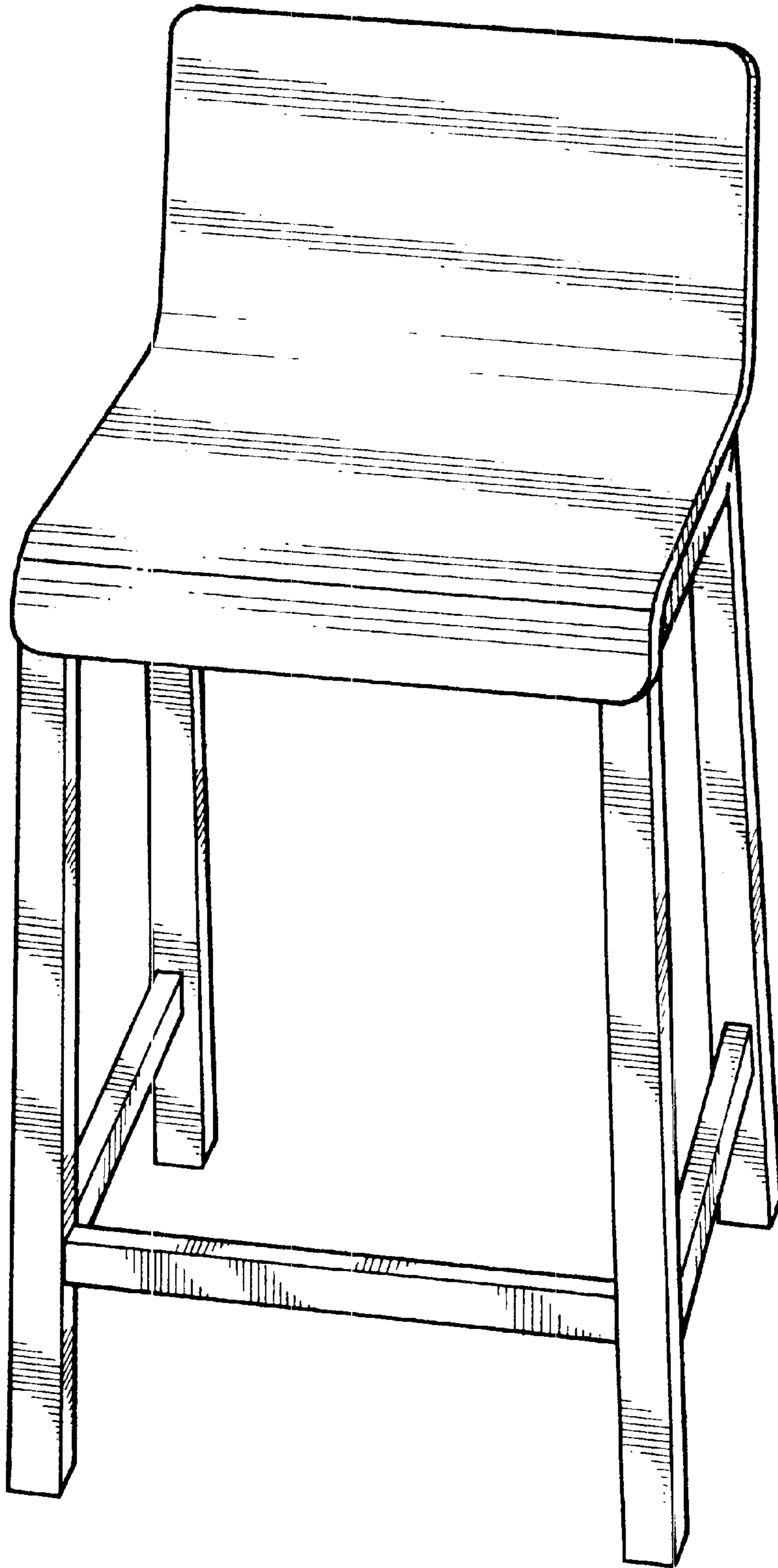
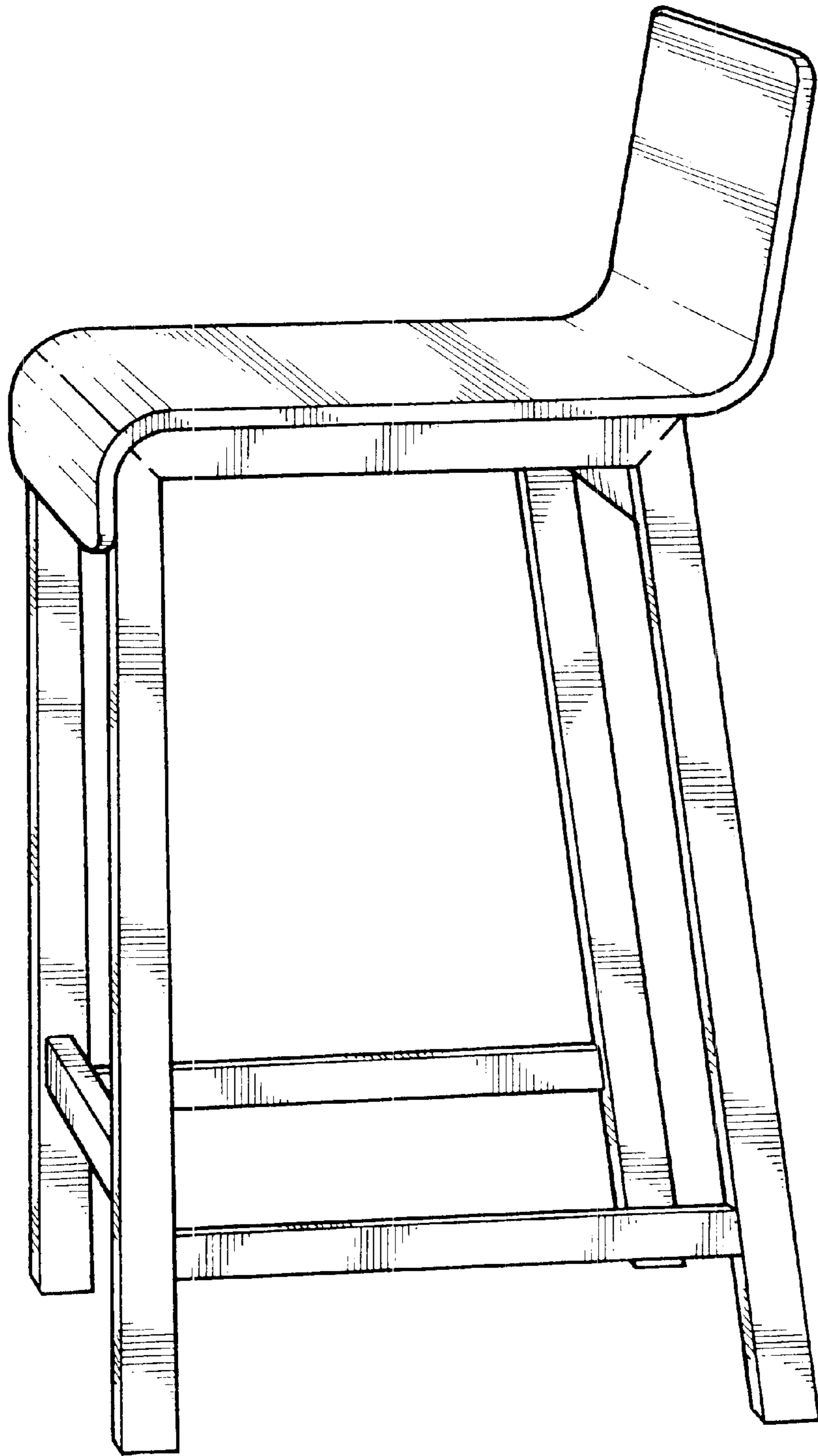

FIG. 8



**FIG. 9**





**FIG.10**

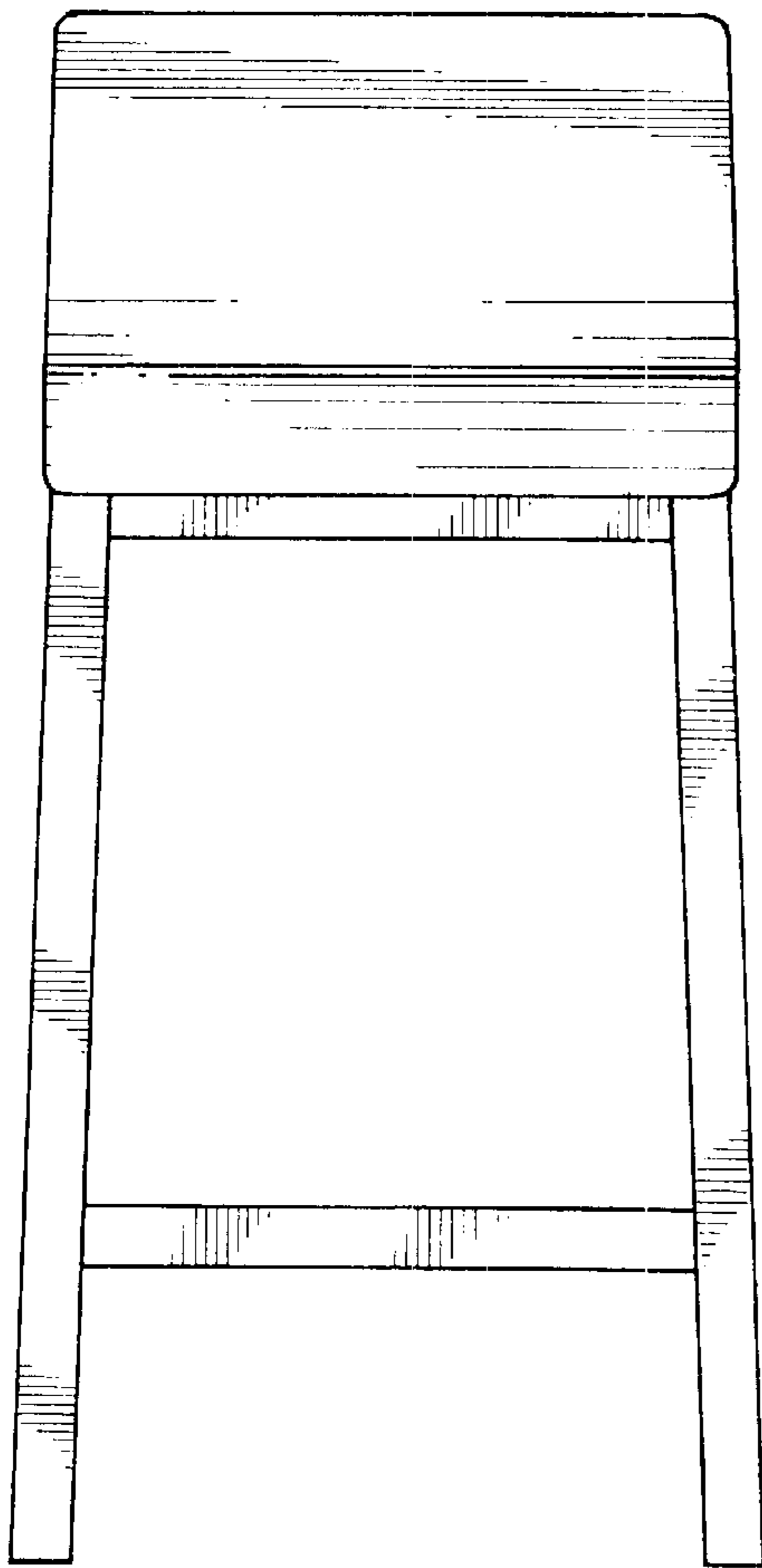

FIG.11

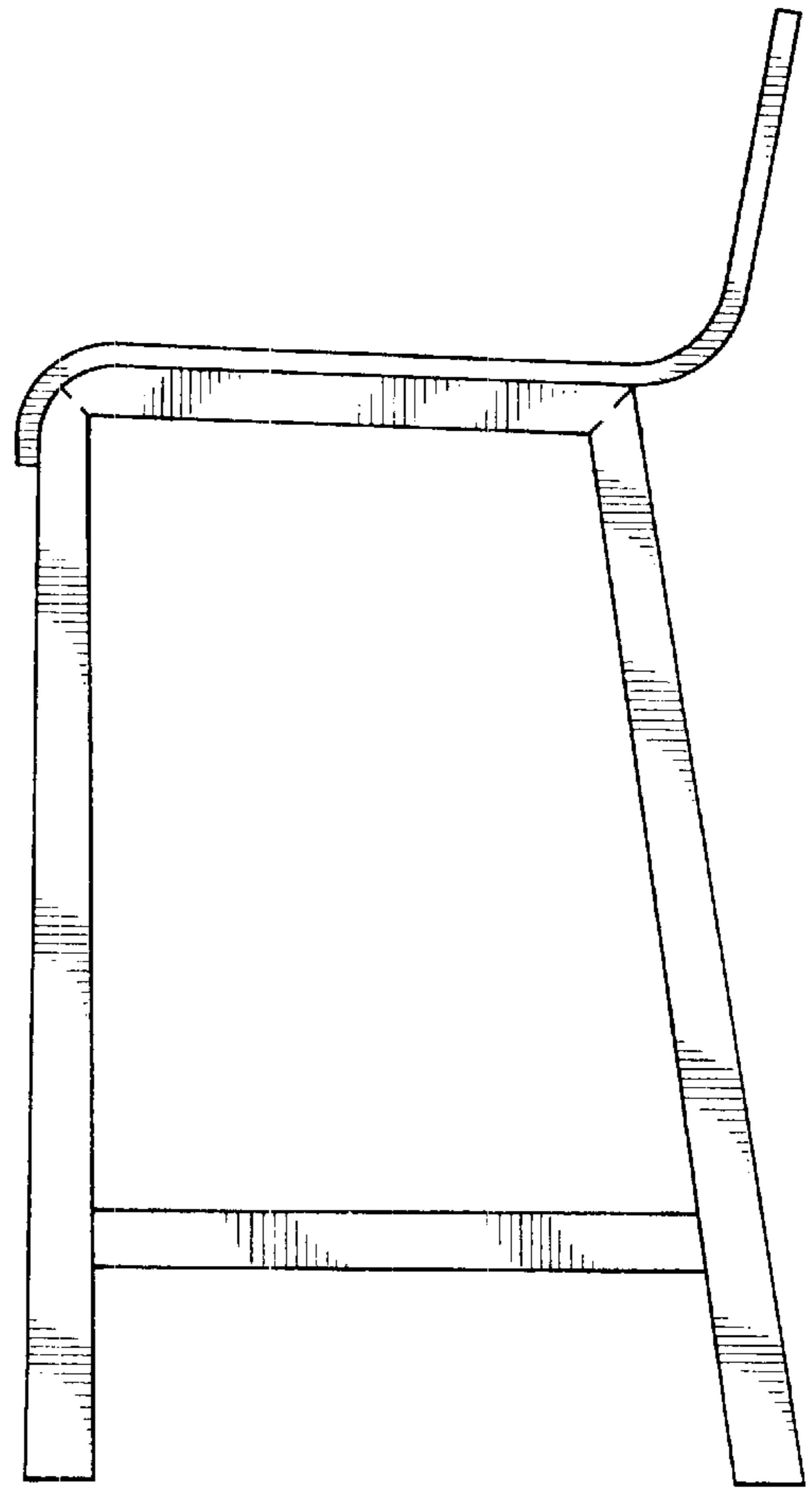
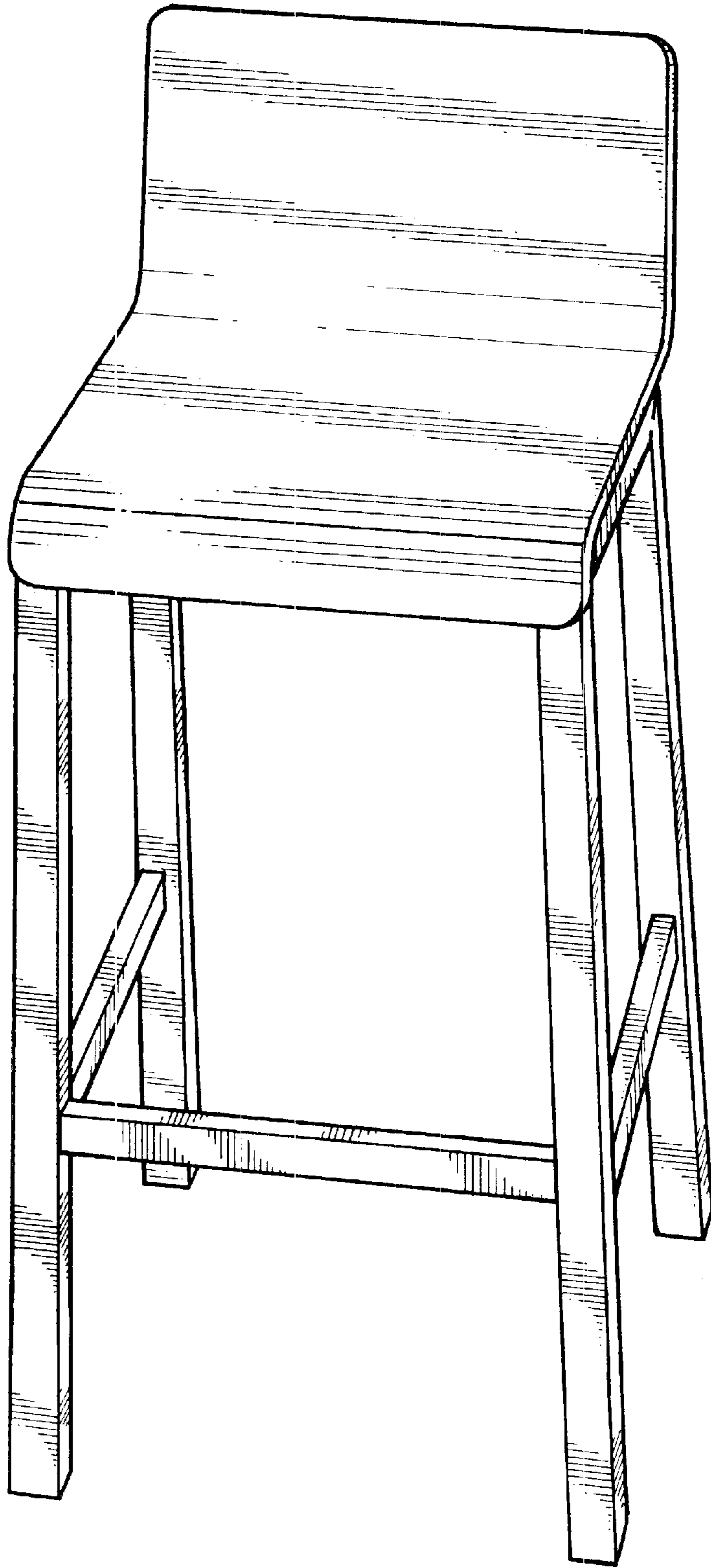

FIG.12



**FIG.13**

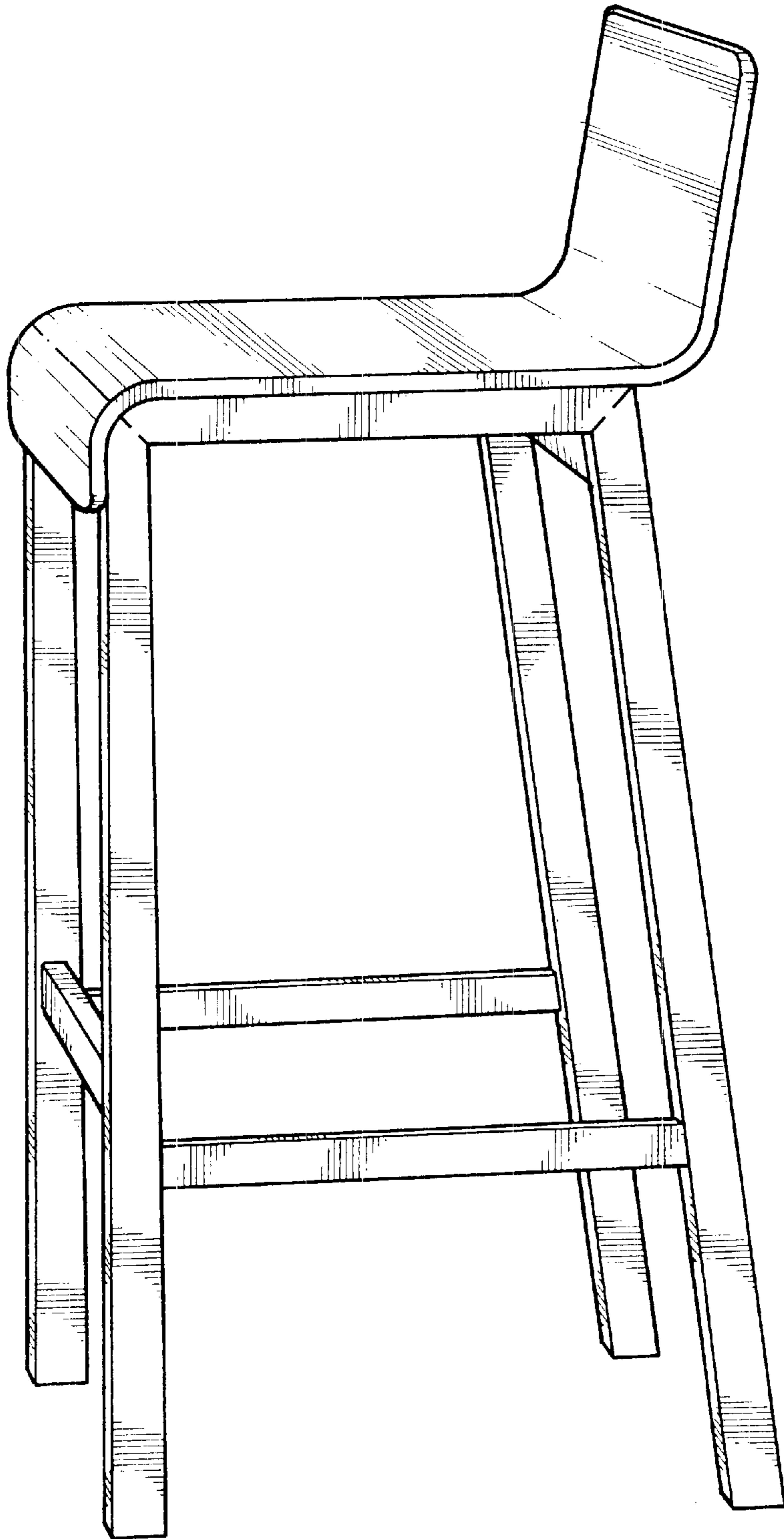

FIG.14

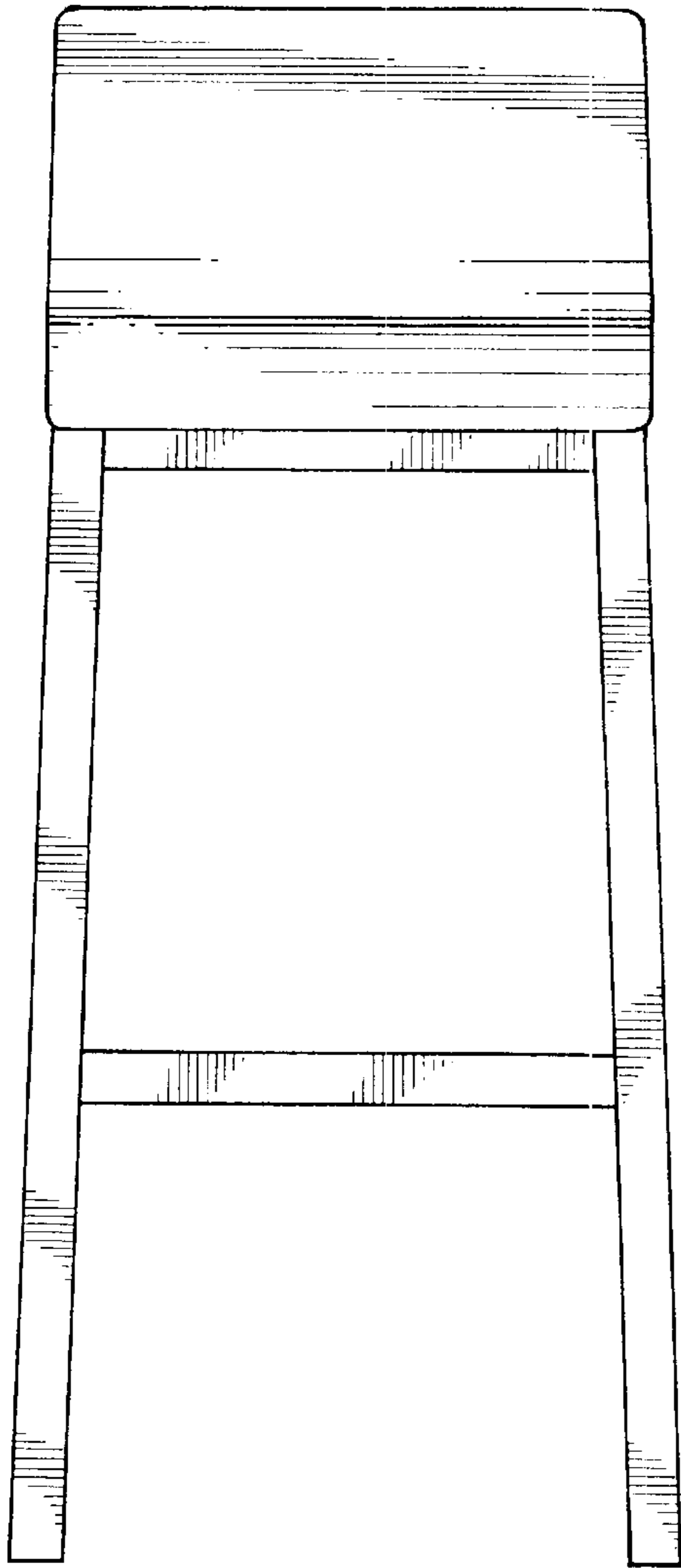

FIG.15

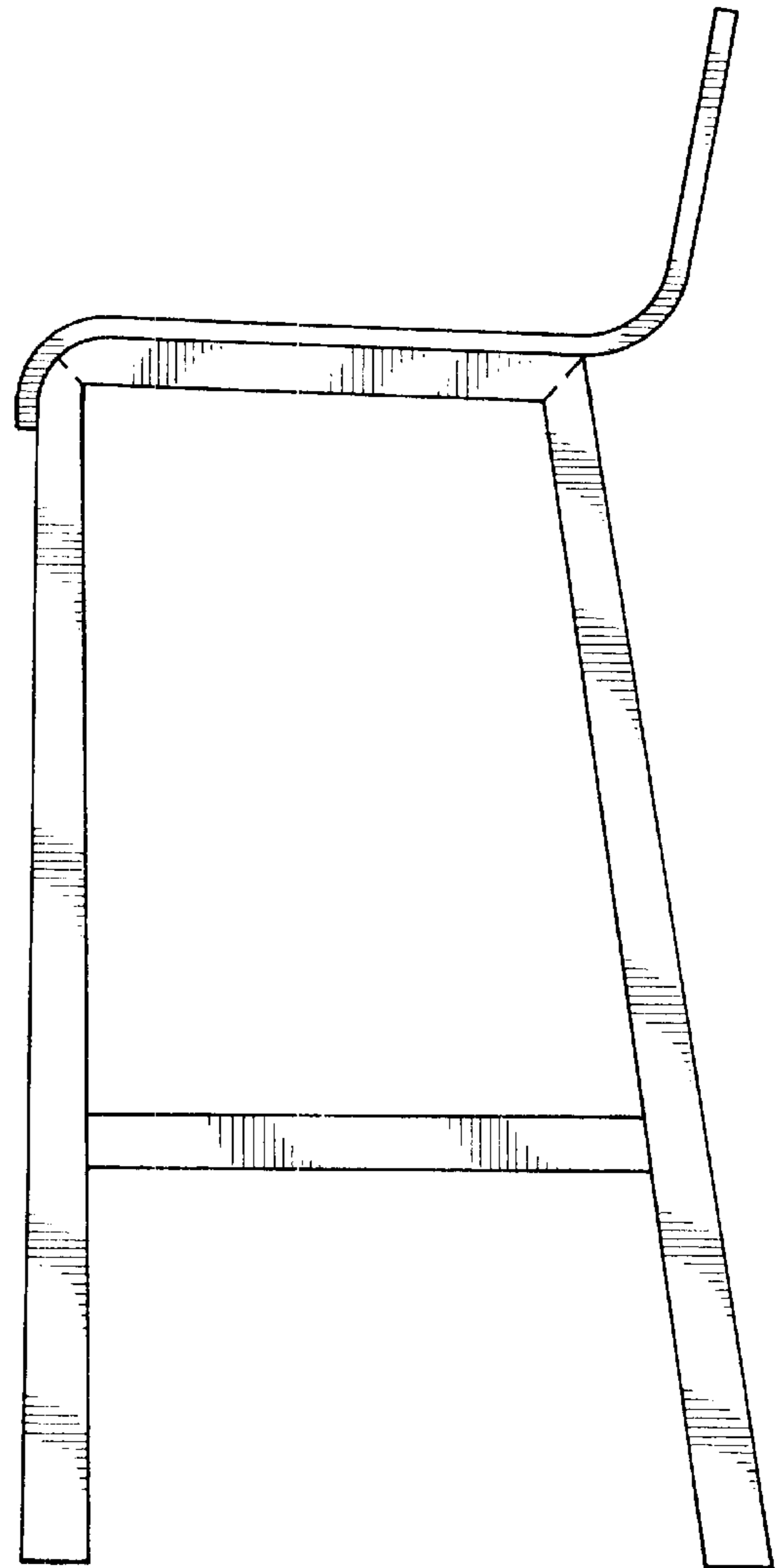

FIG.16