



US00D468896S

(12) **United States Design Patent**
Adams et al.

(10) **Patent No.:** **US D468,896 S**
(45) **Date of Patent:** **** Jan. 21, 2003**

(54) **PORTION OF A SHOE UPPER**
(75) Inventors: **Fiona Jane Adams**, Santa Barbara, CA
(US); **Christjane Burg**, Ventura, CA
(US)

(73) Assignee: **Global Brand Marketing, Inc.**, Santa
Barbara, CA (US)

(**) Term: **14 Years**

(21) Appl. No.: **29/153,357**

(22) Filed: **Jan. 2, 2002**

Related U.S. Application Data

(62) Division of application No. 29/144,004, filed on Jun. 21,
2001, now Pat. No. Des. 457,297.

(51) **LOC (7) Cl.** **02-99**

(52) **U.S. Cl.** **D02/969**

(58) **Field of Search** D2/896, 902, 907,
D2/943, 946, 969, 972, 973; 36/45, 50.1,
51, 77 M, 77 R, 83, 88, 113, 114, 126-130

(56) **References Cited**

U.S. PATENT DOCUMENTS

D188,038 S	5/1960	Dassler	
D223,531 S	* 5/1972	McCarthy	D2/907
D226,882 S	5/1973	Powers	
D229,251 S	* 11/1973	Askew	D2/907
D229,900 S	* 1/1974	Powers	D2/907
D232,200 S	7/1974	Inohara	
D238,983 S	3/1976	Senter	
D239,342 S	3/1976	Dassler	
D239,983 S	5/1976	Senter	
D248,513 S	7/1978	Soler	
D253,017 S	10/1979	Marchesi	
D257,074 S	9/1980	Gucci	

4,314,413 A	2/1982	Dassler
D263,643 S	4/1982	Vernonet
D265,015 S	6/1982	Higgins
D272,012 S	1/1984	Trevisani
D273,632 S	5/1984	Ueda
D276,569 S	12/1984	Kohnno
D279,620 S	7/1985	Ueda
D287,422 S	12/1986	MacGregor et al.

(List continued on next page.)

Primary Examiner—Dominic Simone

(74) *Attorney, Agent, or Firm*—Marshall A. Lerner, Esq.;
Finn T. Simmenssen, Esq.; Kleinberg & Lerner, LLP

(57) **CLAIM**

The ornamental design for a portion of a shoe upper, as
shown and described.

DESCRIPTION

FIG. 1 is a perspective view of the portion of a shoe upper
showing our new design;
FIG. 2 is a left side elevational view thereof;
FIG. 3 is a top plan view thereof;
FIG. 4 is a right side elevational view thereof;
FIG. 5 is a front elevational view thereof;
FIG. 6 is a rear elevational view thereof;
FIG. 7 is a perspective view of an alternative embodiment of
the portion of a shoe upper showing our new design;
FIG. 8 is a left side elevational view thereof;
FIG. 9 is a top plan view thereof;
FIG. 10 is a right side elevational view thereof;
FIG. 11 is a front elevational view thereof; and,
FIG. 12 is a rear elevational view thereof.

The broken line showing the sole in the figures is for
illustrative purposes only and forms no part of the claimed
design.

1 Claim, 12 Drawing Sheets

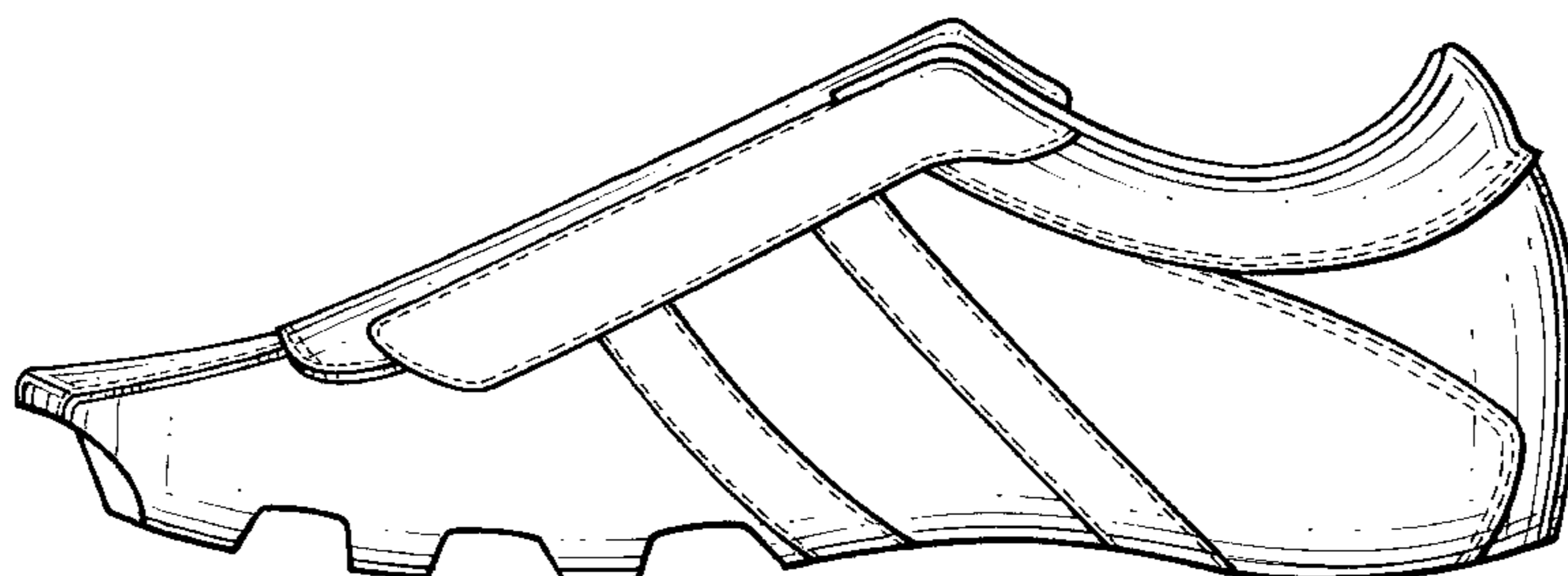
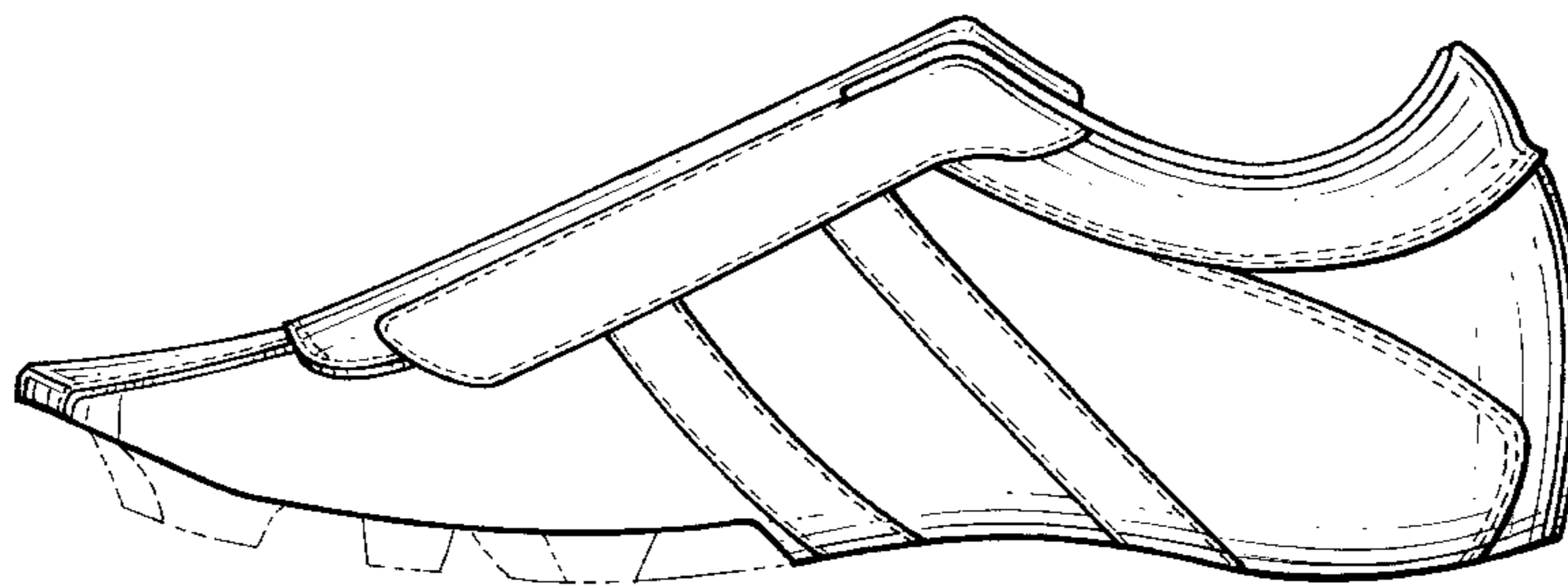

US D468,896 S

Page 2

U.S. PATENT DOCUMENTS

D287,782 S	1/1987	Palacio	D419,756 S	2/2000	Edwards
4,651,447 A	3/1987	Sullivan	D426,372 S	6/2000	Price
D290,901 S	7/1987	Tong et al.	D432,773 S	10/2000	Debiase
D291,142 S *	8/1987	Kelley D2/969	D435,162 S	12/2000	Wilson
4,949,476 A	8/1990	Anderie	D436,720 S	1/2001	Debiase
D337,723 S	7/1993	Cordeiro	D444,622 S	7/2001	Wilson
5,295,315 A	3/1994	Osawa et al.	D444,624 S	7/2001	Wilson
D361,884 S	9/1995	Lozano	D448,550 S	10/2001	Yang
D402,454 S *	12/1998	Kelchak D2/969	D449,922 S *	11/2001	Pollastrelli D2/969
D402,456 S	12/1998	Greenberg	D451,266 S	12/2001	Schroeder et al.
D407,201 S	3/1999	Backus et al.	D457,295 S *	5/2002	Puris D2/969
D411,246 S	6/1999	Jimenez	D457,297 S *	5/2002	Adams et al. D2/969
D413,718 S	9/1999	Lupo			

* cited by examiner

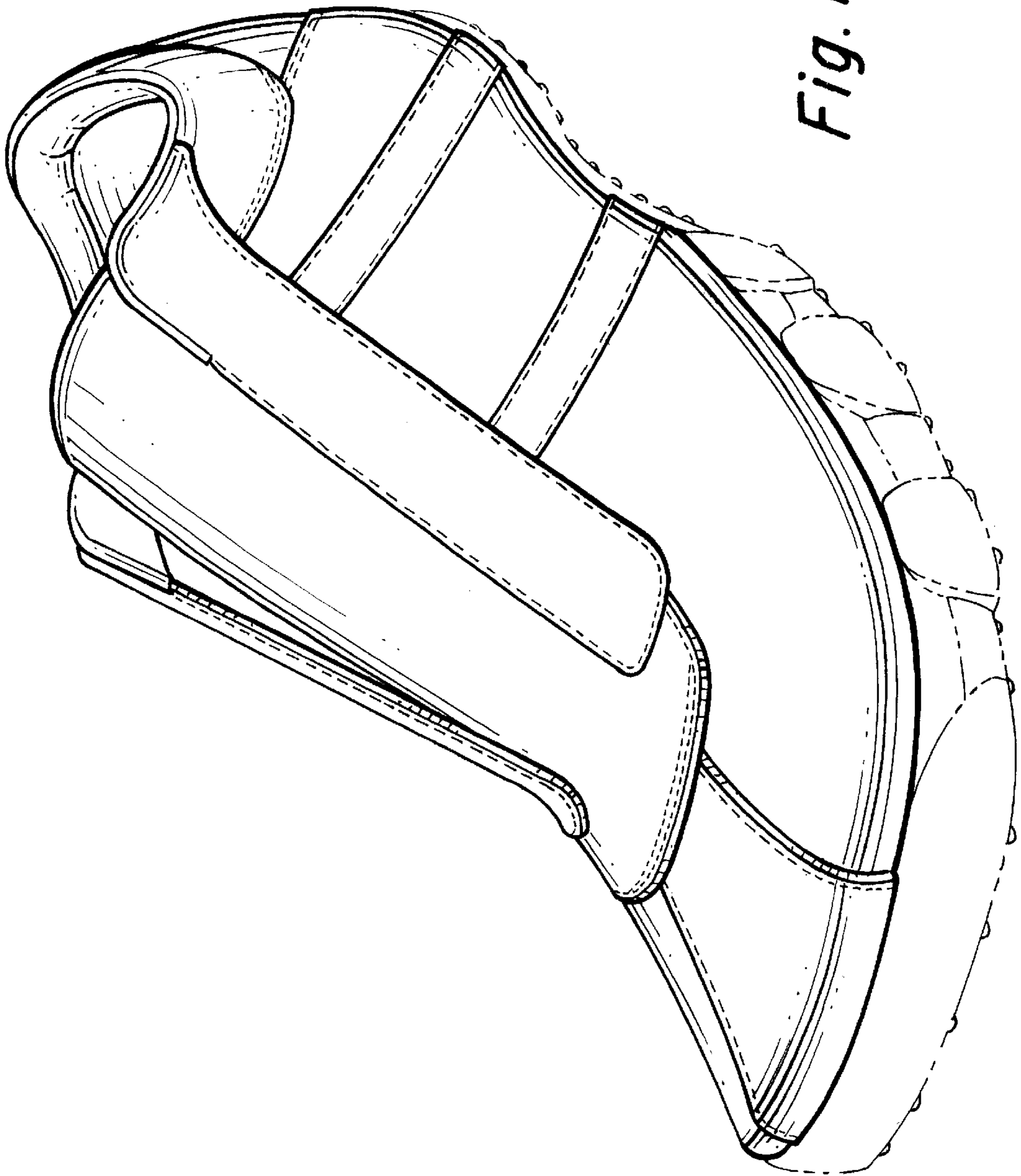

Fig. 1.

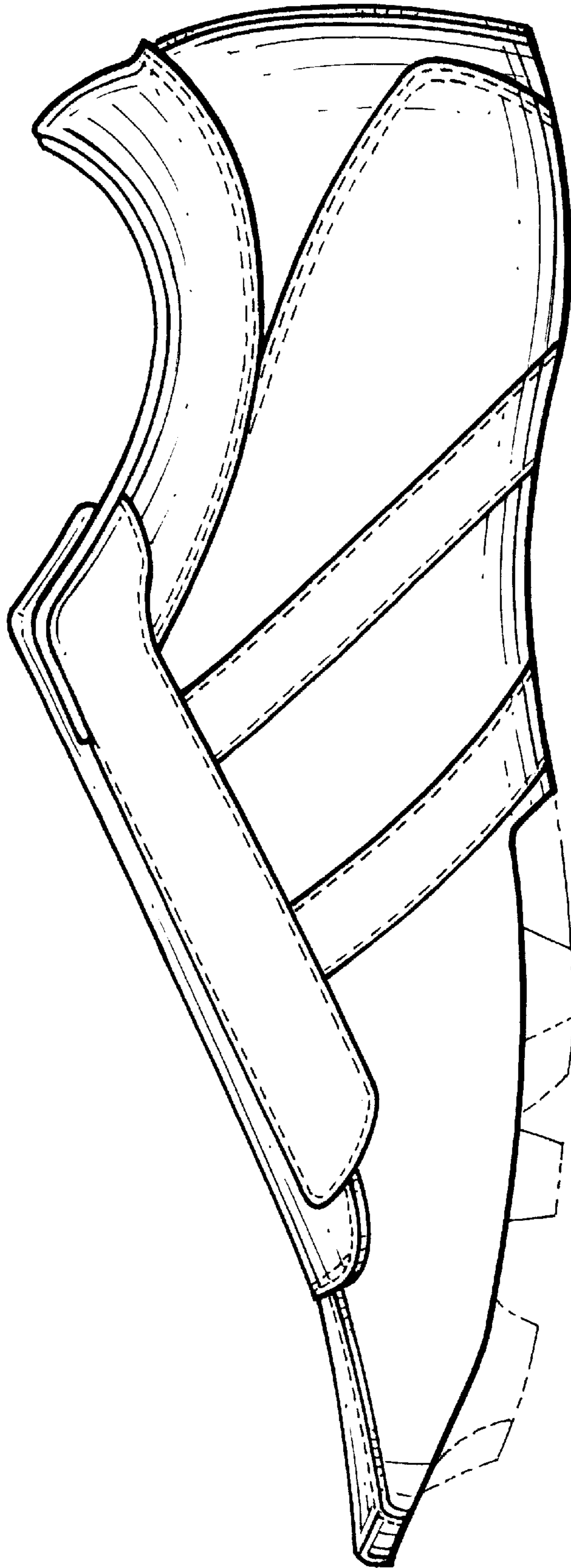

Fig. 2.

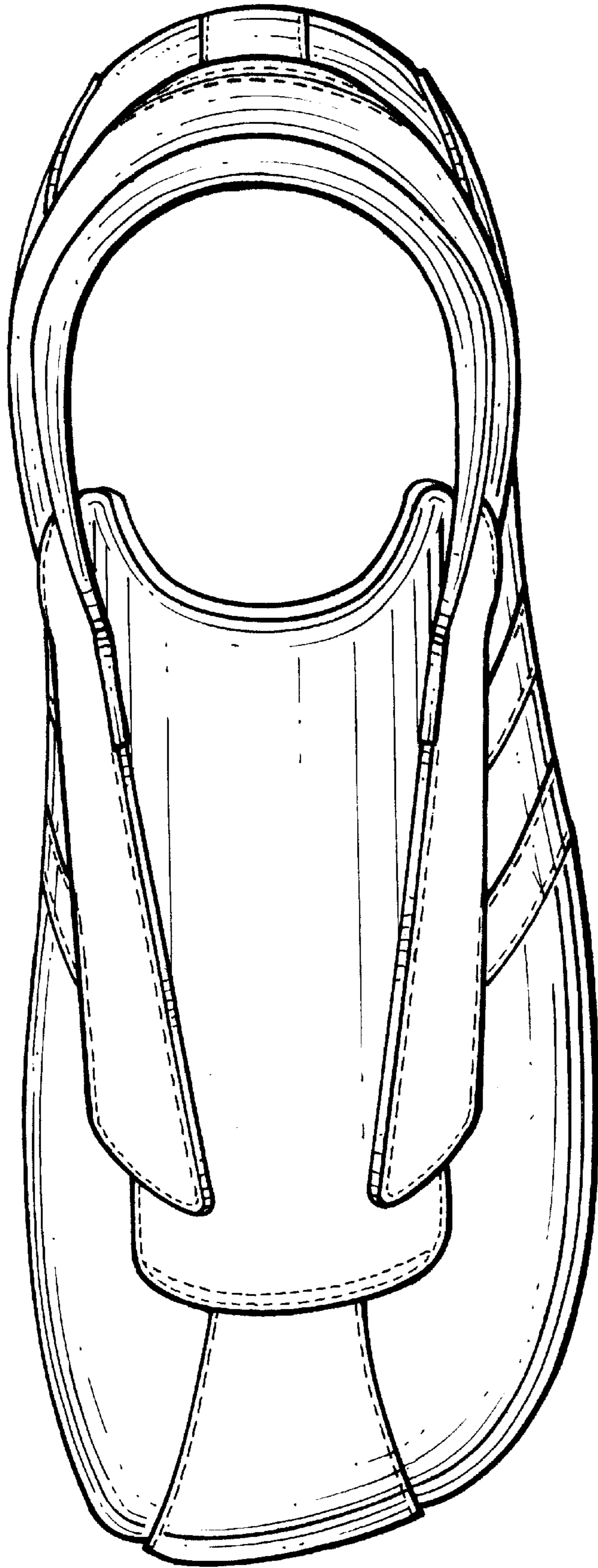

Fig. 3.

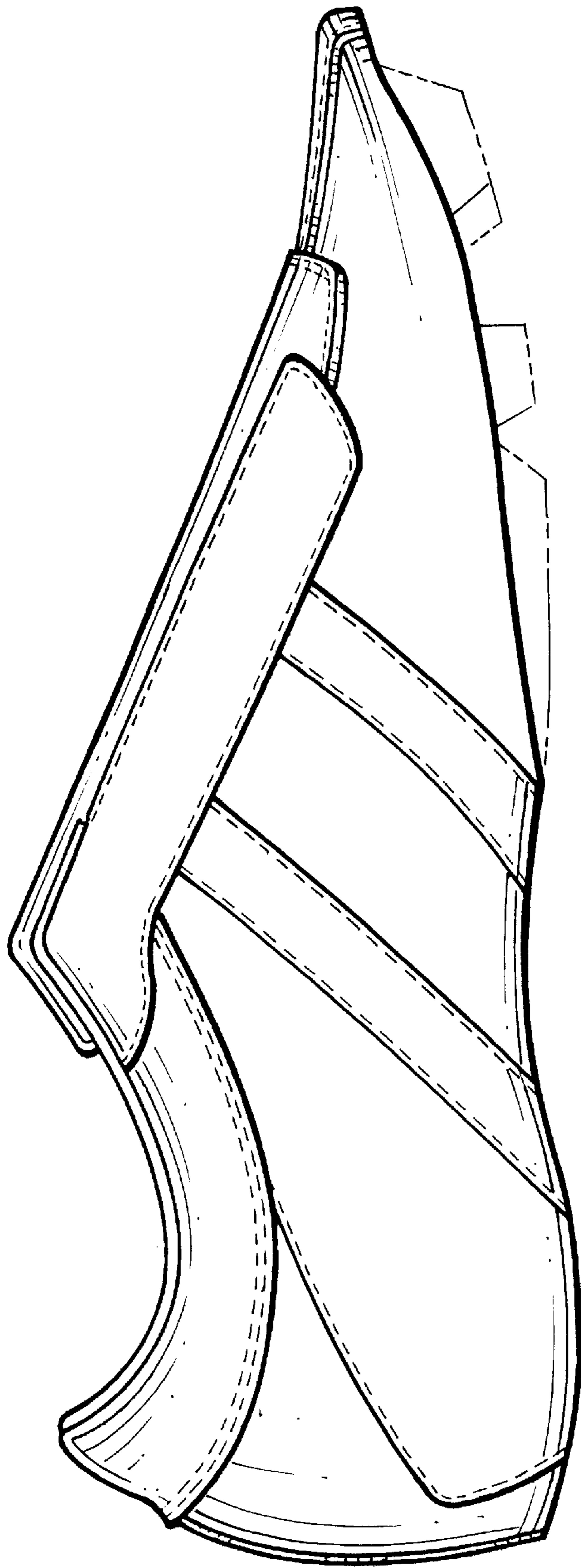

Fig. 4.

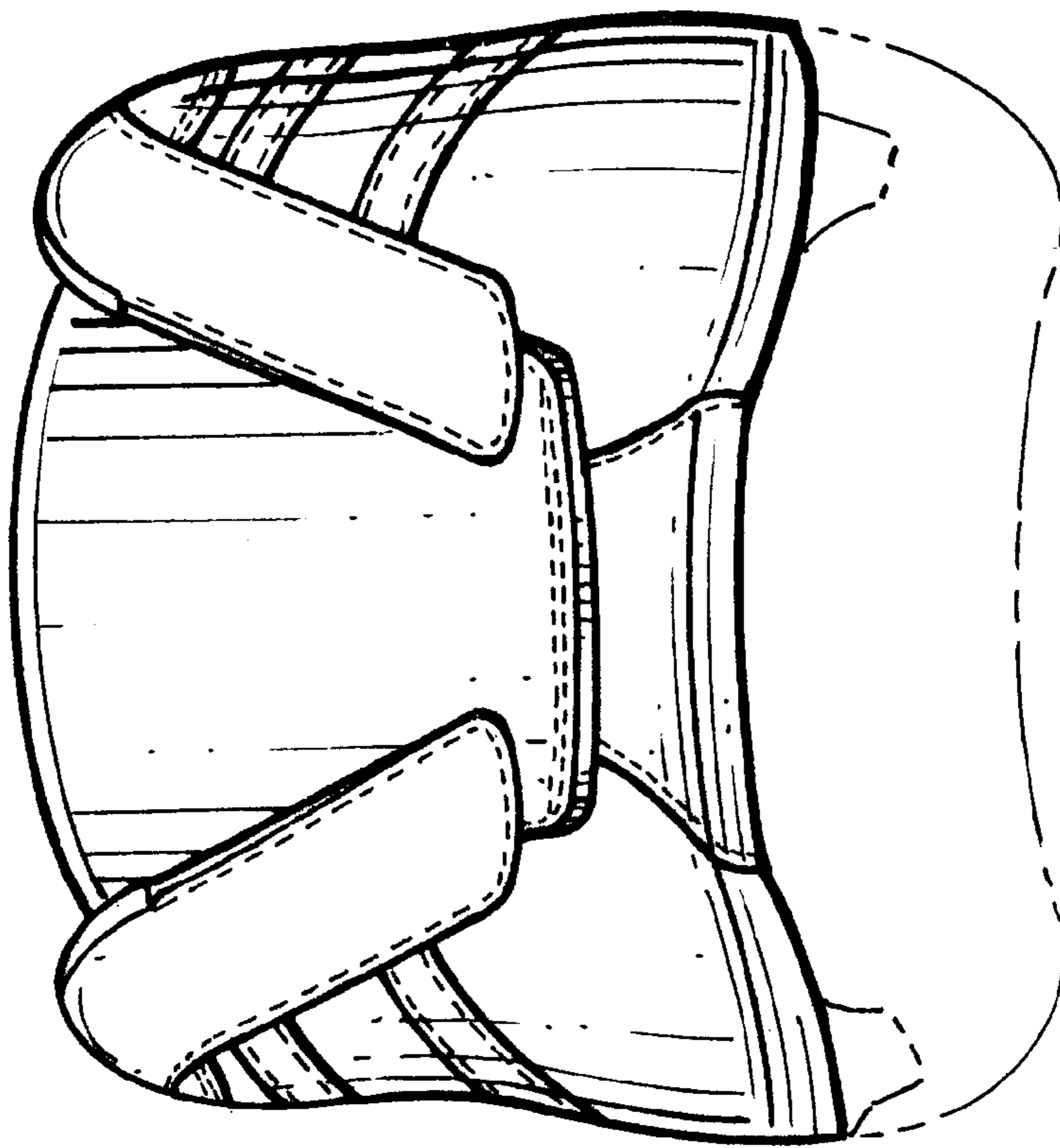

Fig. 5.

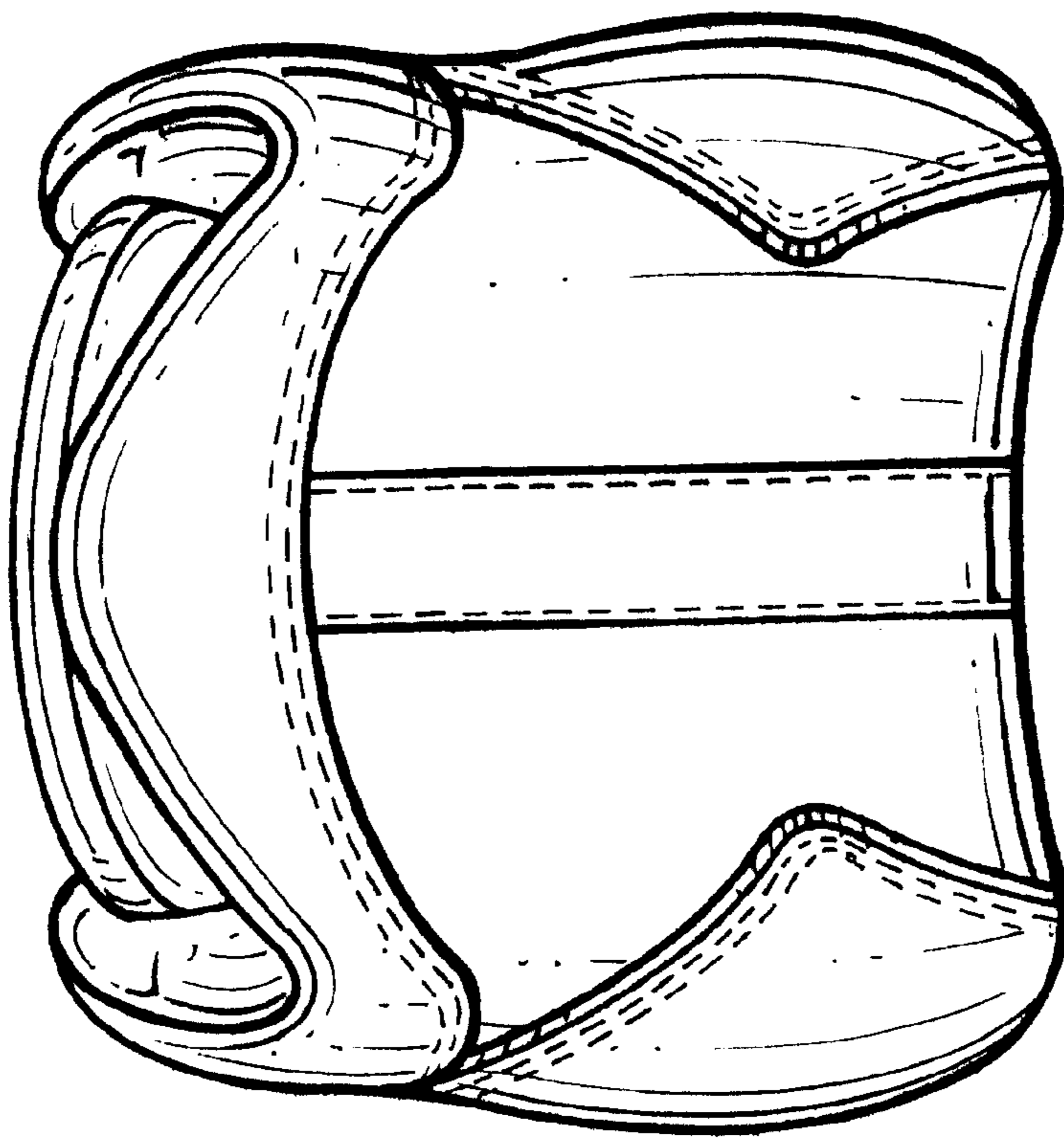

Fig. 6.

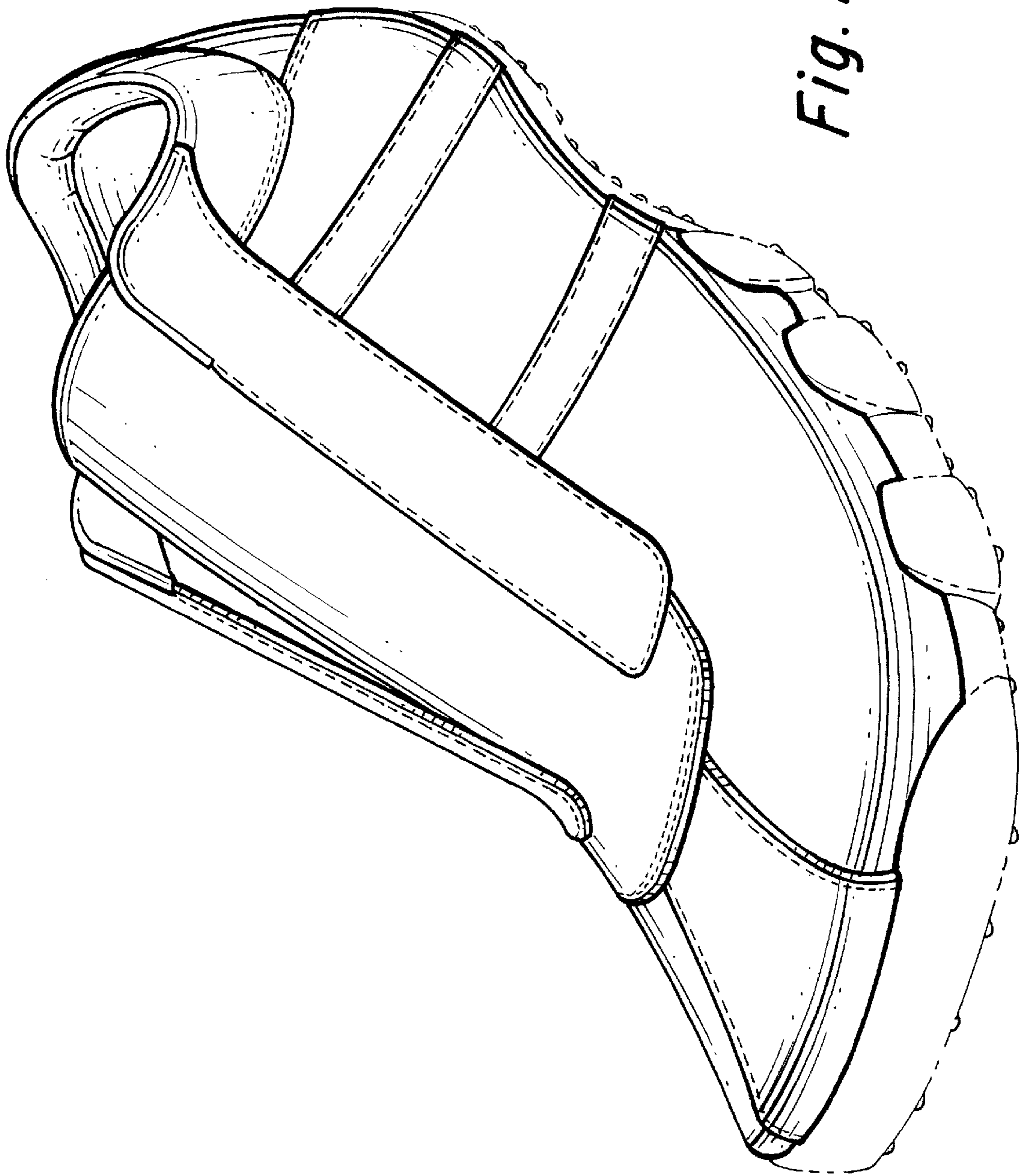

Fig. 7.

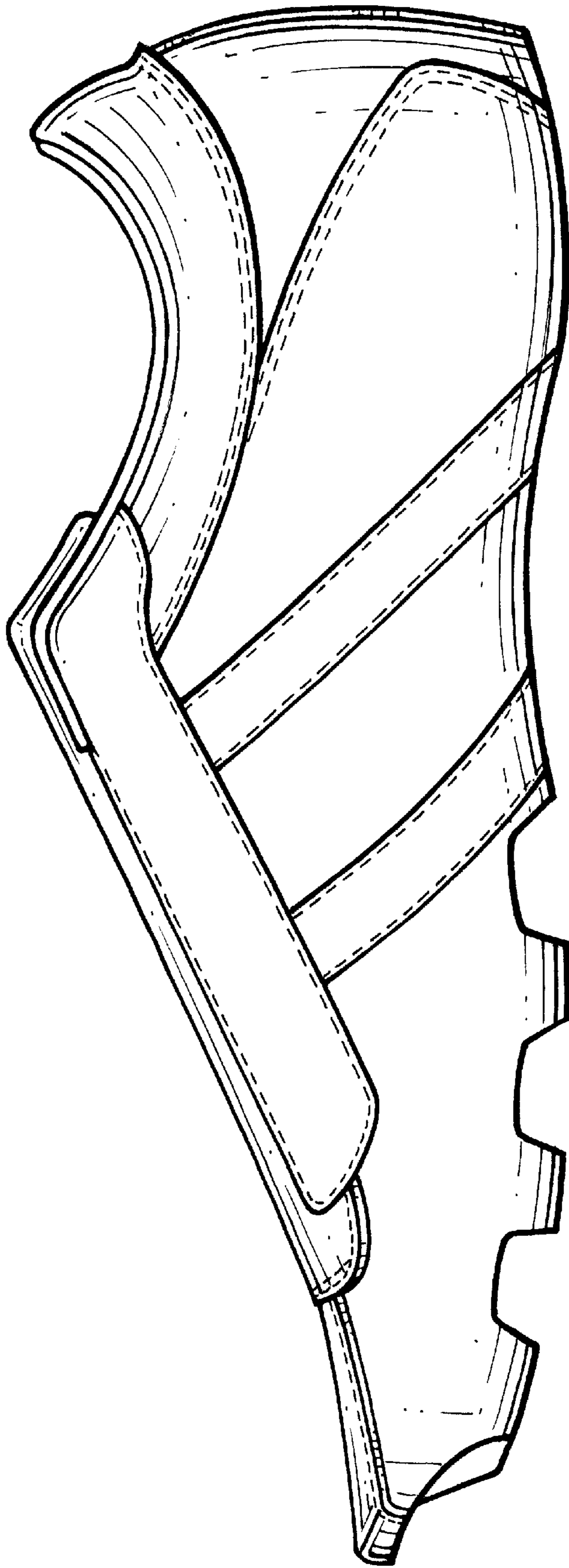

Fig. 8.

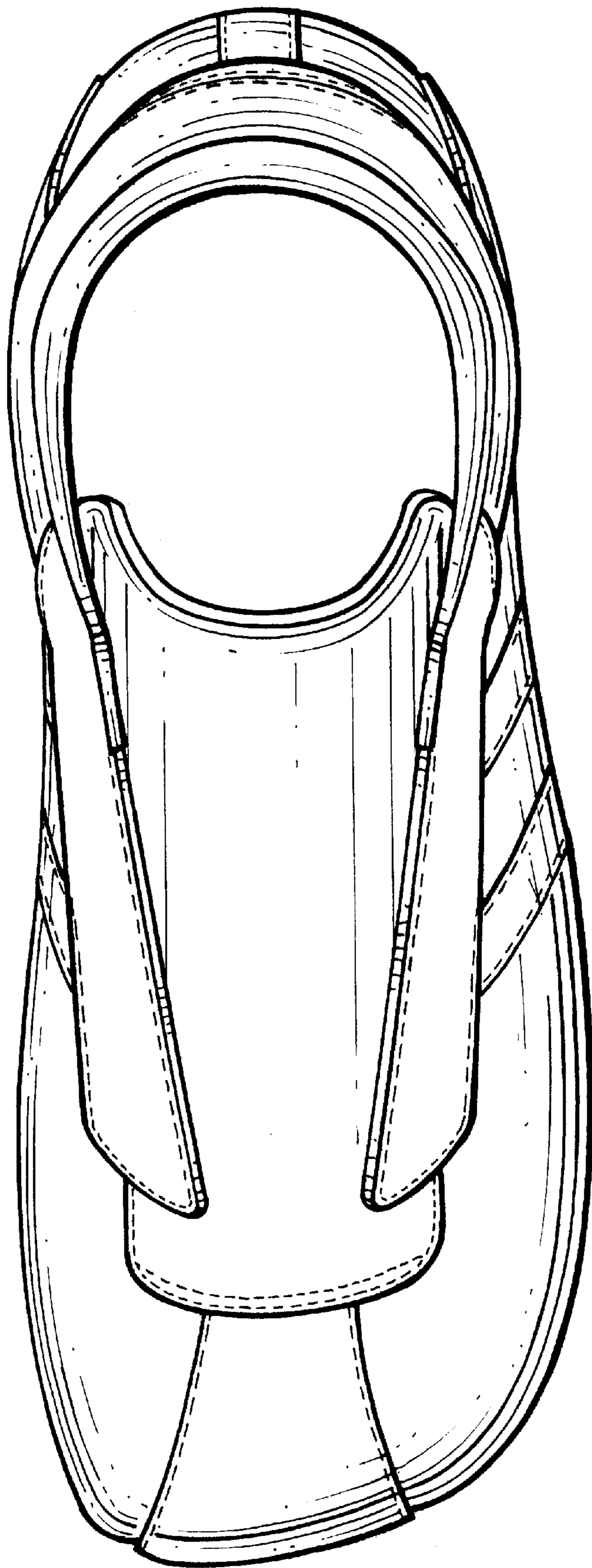

Fig. 9.

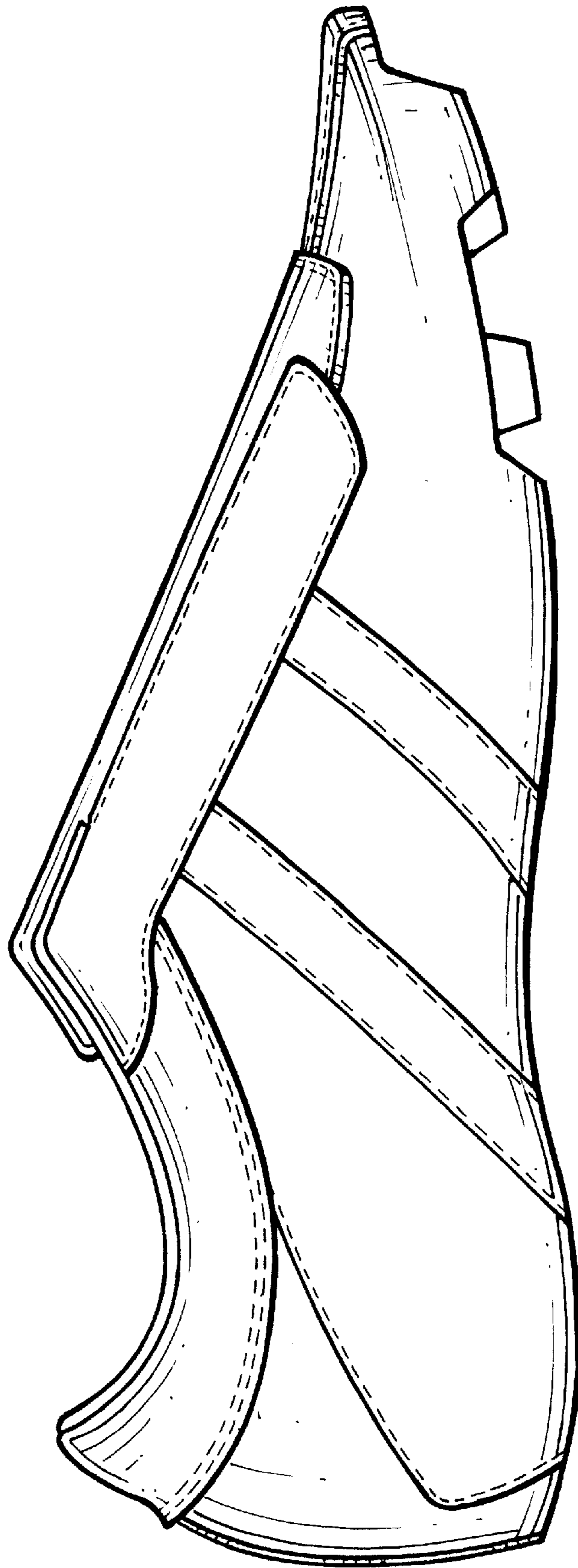

Fig. 10.

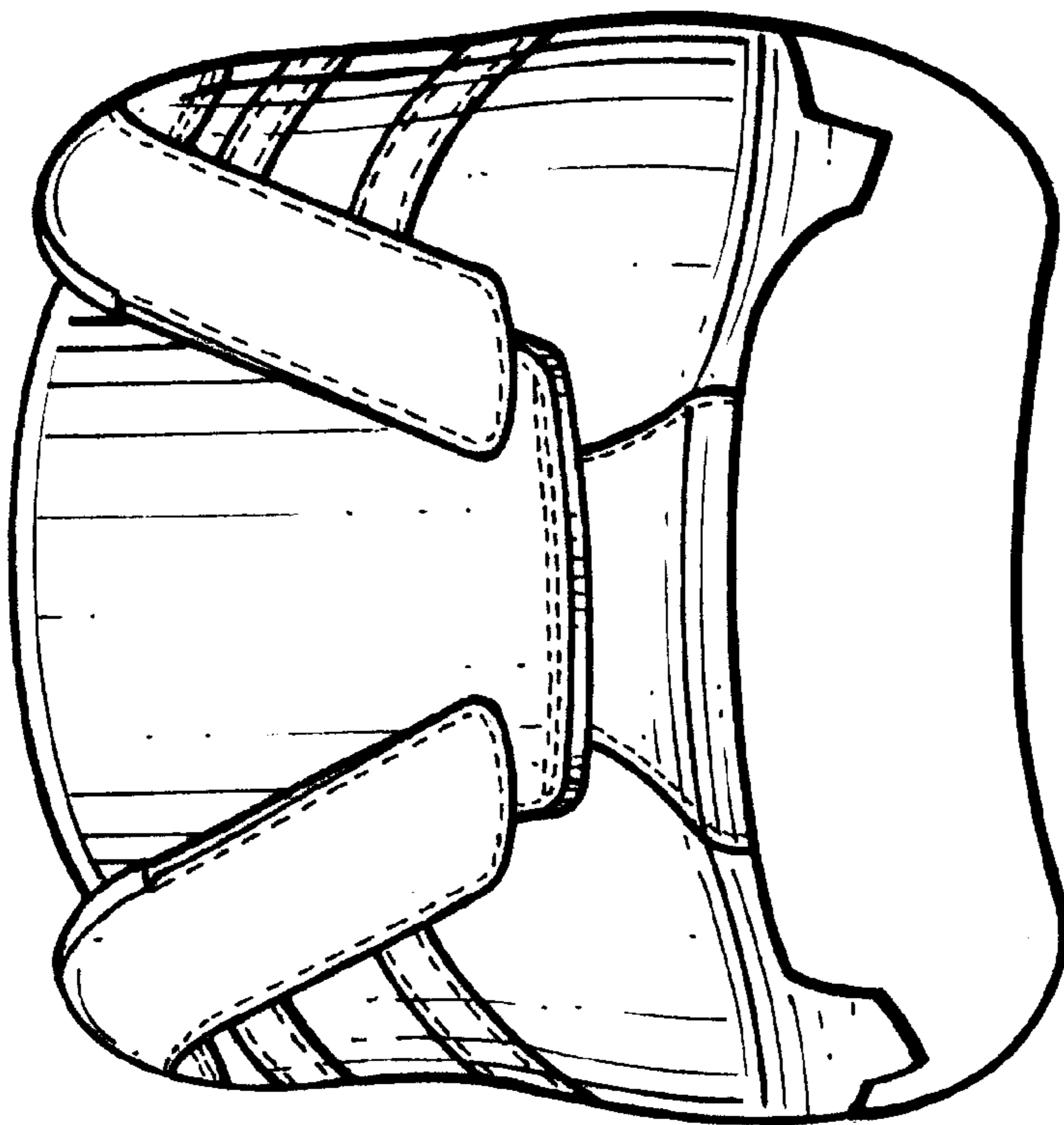

Fig. 11.

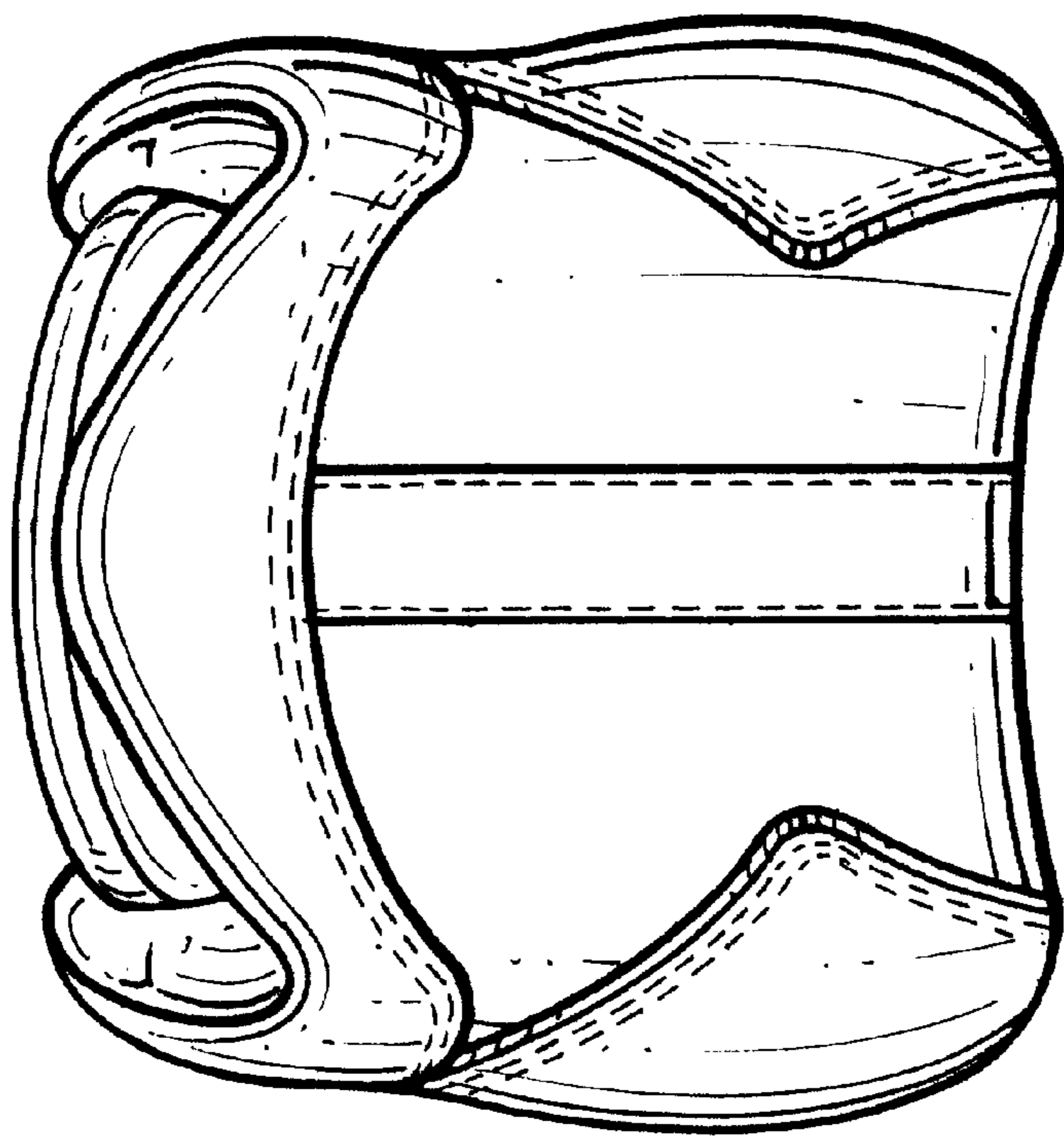

Fig. 12.