



US00D468855S

(12) **United States Design Patent**
Gismondi

(10) **Patent No.:** **US D468,855 S**

(45) **Date of Patent:** **** Jan. 14, 2003**

(54) **TABLE LAMP**

(75) **Inventor:** **Ernesto Gismondi, Milan (IT)**

(73) **Assignee:** **Artemide S.p.A., Milan (IT)**

(**) **Term:** **14 Years**

(21) **Appl. No.:** **29/149,178**

(22) **Filed:** **Oct. 4, 2001**

(30) **Foreign Application Priority Data**

Apr. 4, 2001 (IT) MI0100254

(51) **LOC (7) Cl.** **26-03**

(52) **U.S. Cl.** **D26/109**

(58) **Field of Search** D26/61-66, 93-112;
362/217, 220, 260, 269, 274, 275, 277,
282, 283, 285, 287, 410-414

(56) **References Cited**

U.S. PATENT DOCUMENTS

D211,387 S * 6/1968 Muller D26/64

D382,362 S * 8/1997 Huang D26/65

D430,686 S * 9/2000 Gismondi D26/63

D450,408 S * 11/2001 Wang D26/109

* cited by examiner

Primary Examiner—Robin V. Taylor

Assistant Examiner—Linda Brooks

(74) *Attorney, Agent, or Firm*—Pitney, Hardin, Kipp & Szuch LLP

(57) **CLAIM**

The ornamental design for a table lamp, substantially as shown and described.

DESCRIPTION

FIG. 1 is a front view of my new design relating to a table lamp;

FIG. 2 is a left side view thereof, the right side view being specular;

FIG. 3 is a rear view thereof;

FIG. 4 is a bottom plan view thereof;

FIG. 5 is a top plan view thereof; and,

FIG. 6 is a three-quarter top view in perspective thereof.

1 Claim, 2 Drawing Sheets

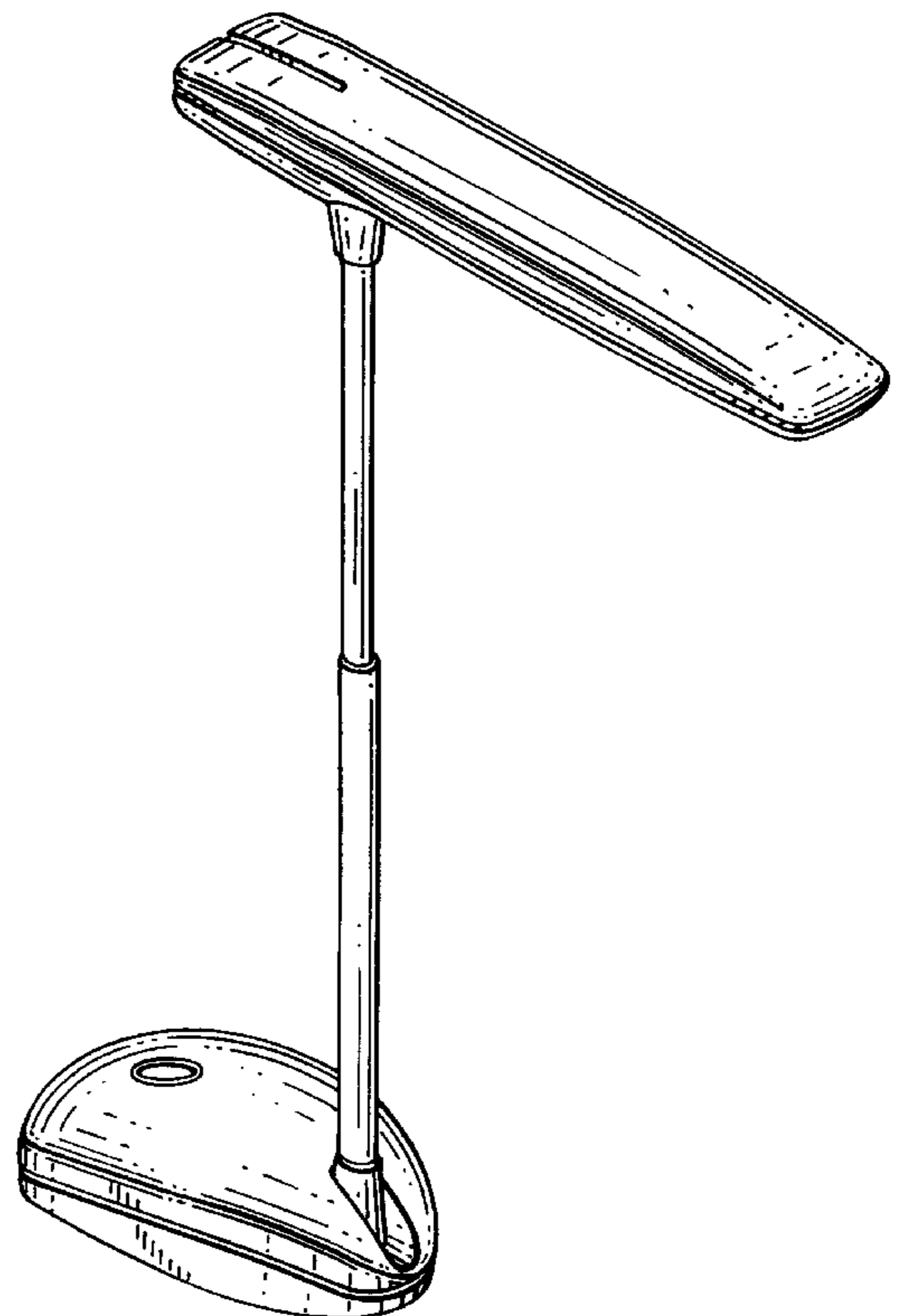
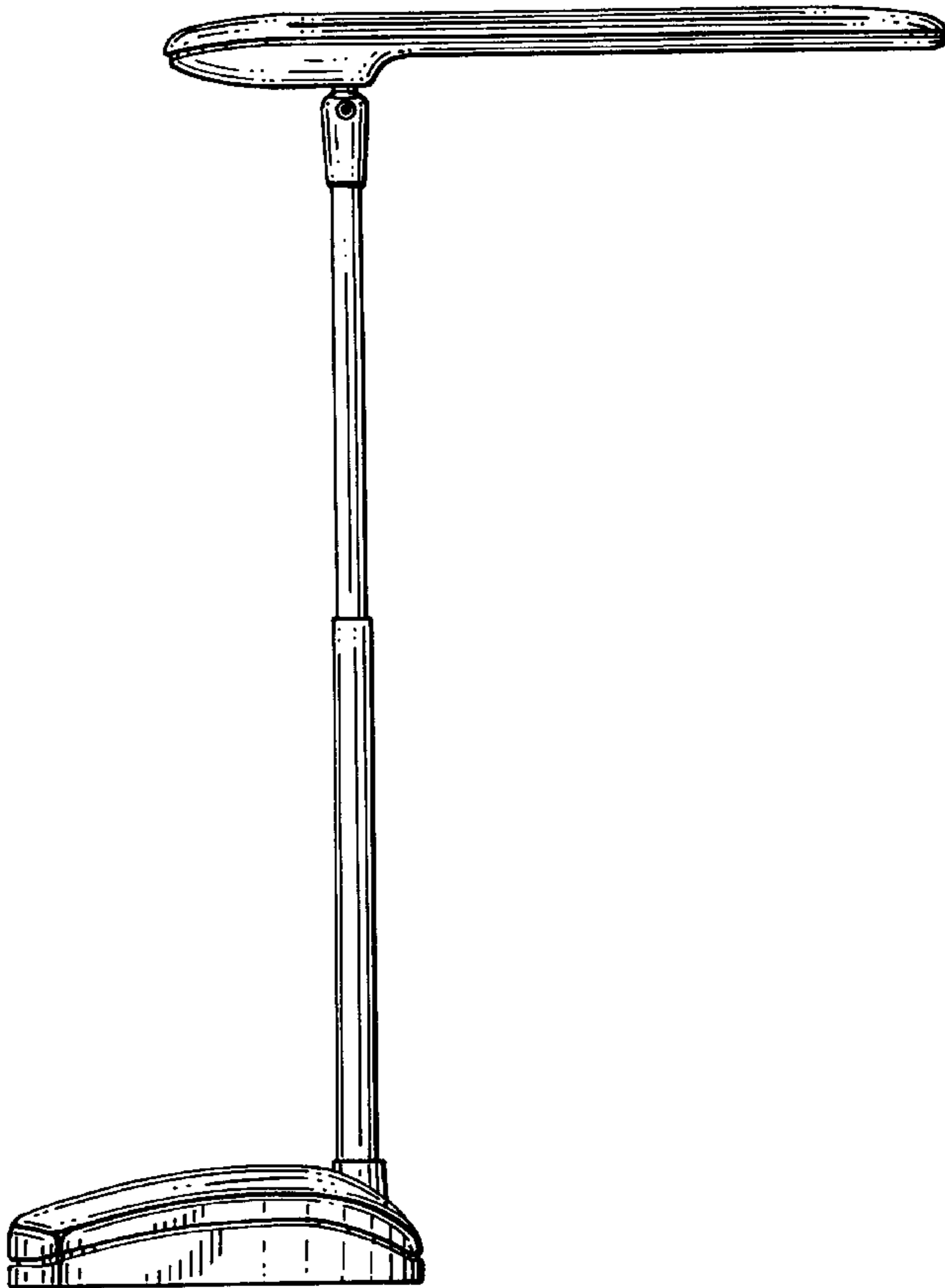

FIG. 1

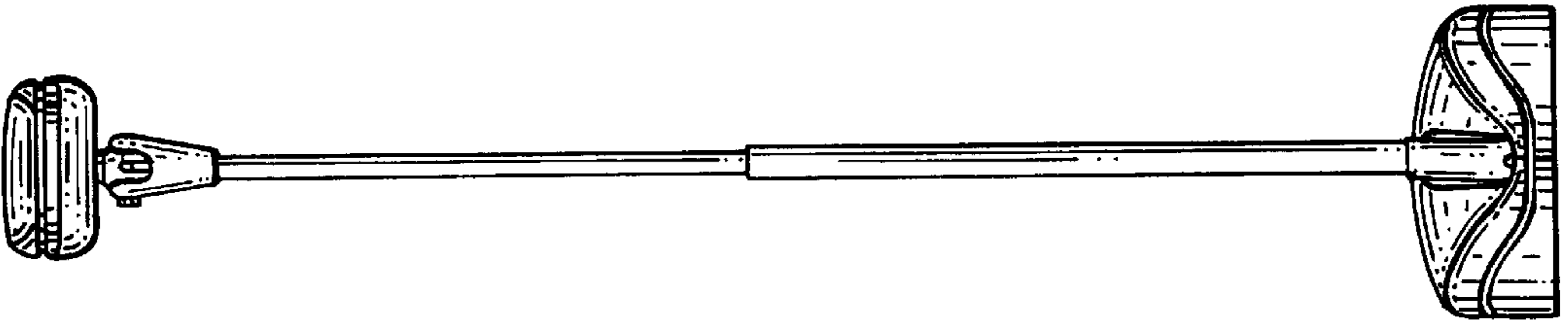

FIG. 2

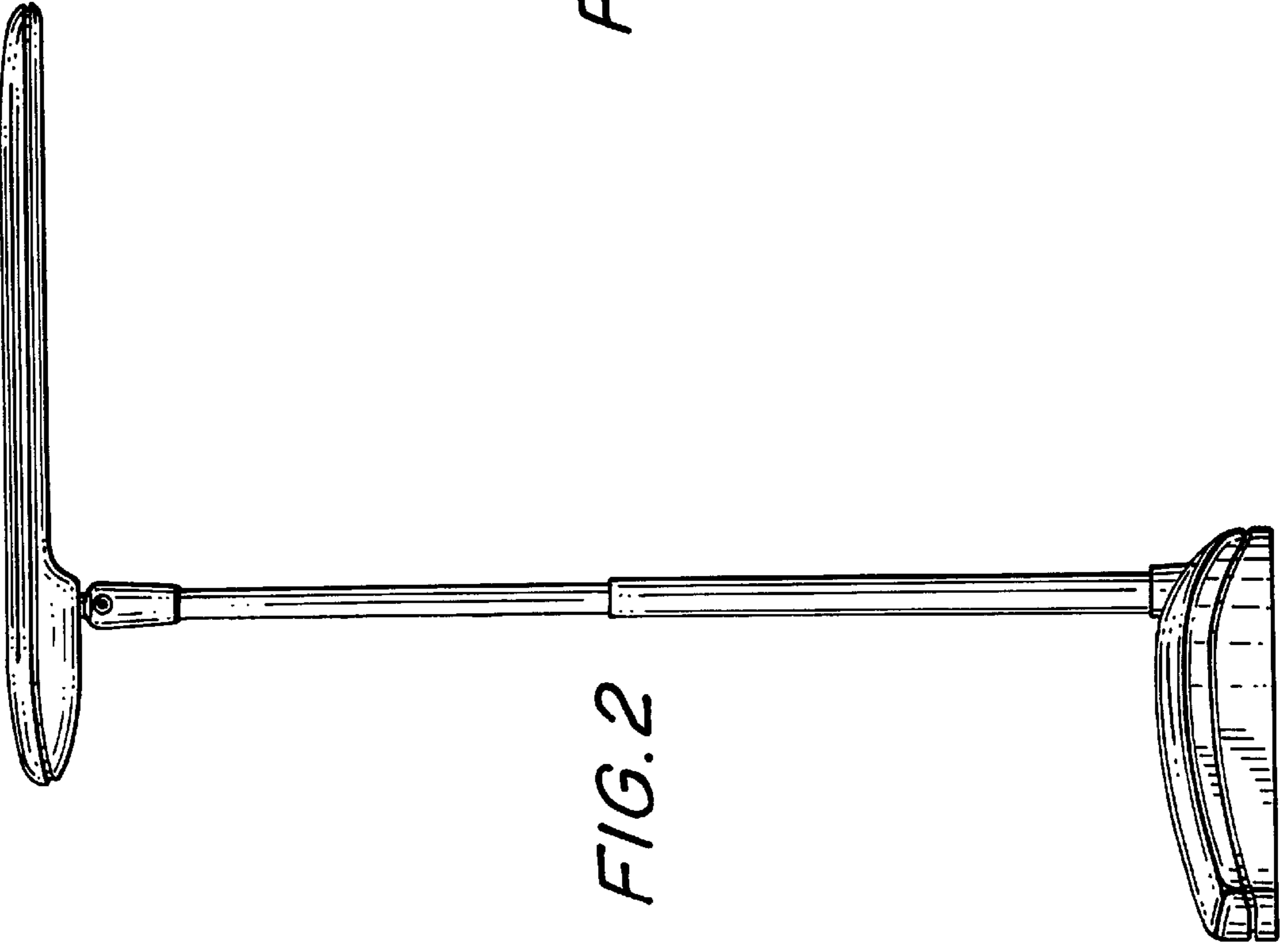
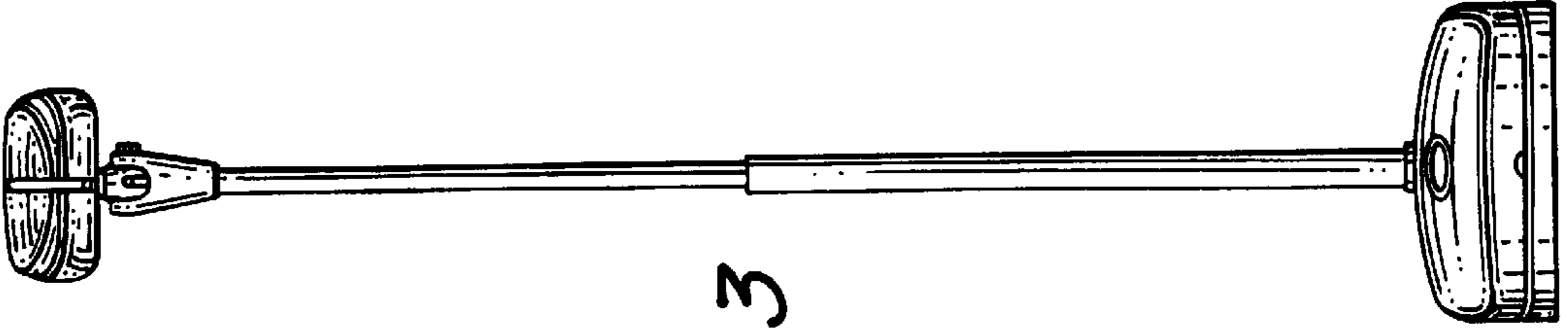

FIG. 3



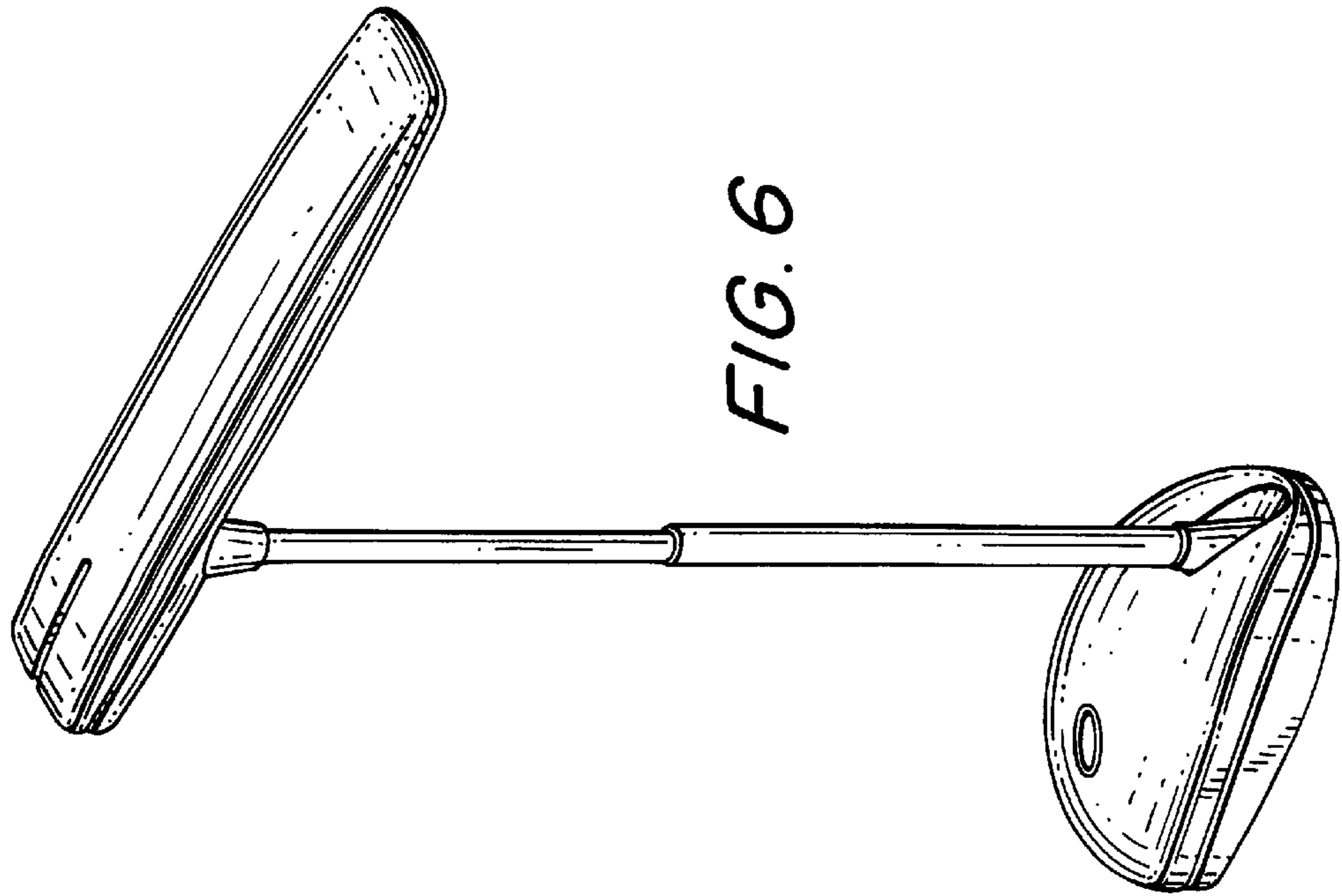

FIG. 6

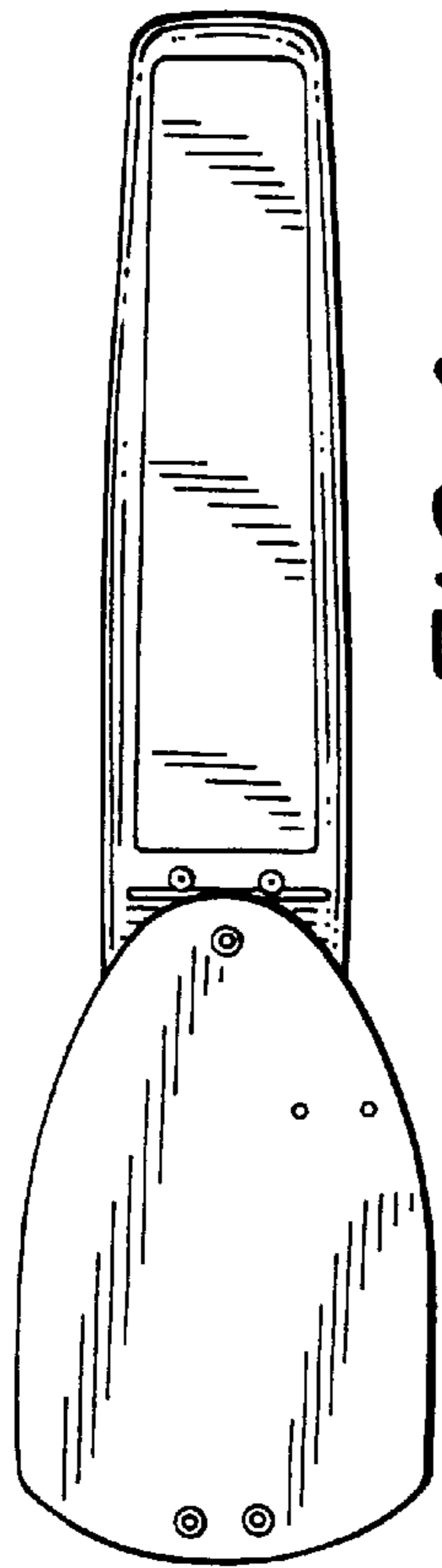

FIG. 4

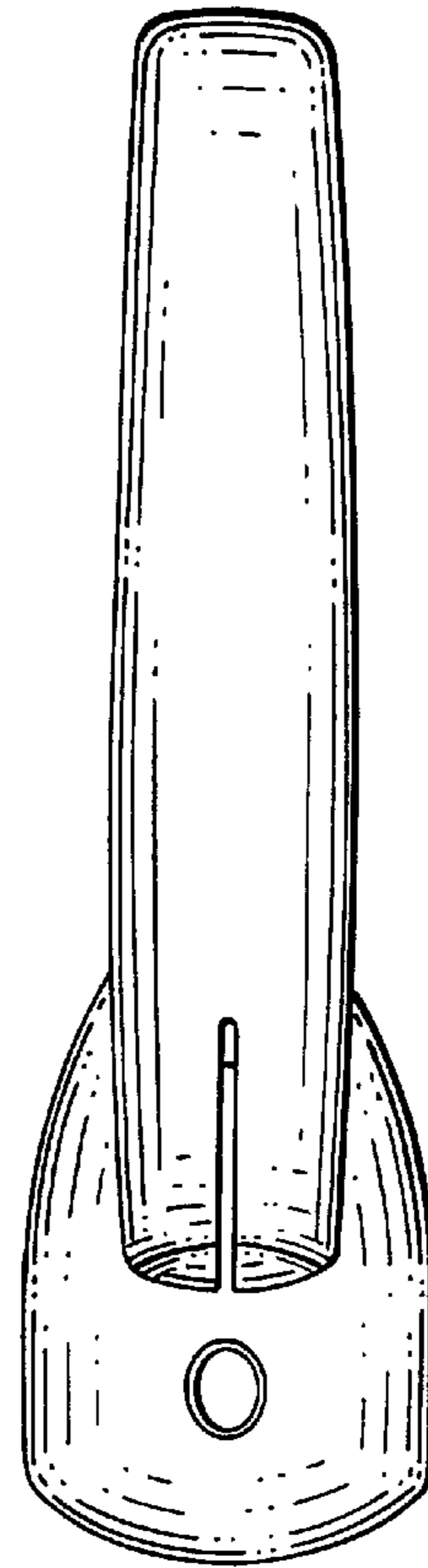

FIG. 5