



US00D468767S

(12) **United States Design Patent**  
**Yamada et al.**

(10) **Patent No.:** **US D468,767 S**

(45) **Date of Patent:** **\*\* Jan. 14, 2003**

(54) **INK CARTRIDGE**

(75) Inventors: **Manabu Yamada, Suwa (JP);**  
**Chiyoshige Nakazawa, Suwa (JP)**

(73) Assignee: **Seiko Epson Corporation, Tokyo (JP)**

(\*\*) Term: **14 Years**

(21) Appl. No.: **29/155,965**

(22) Filed: **Feb. 22, 2002**

**Related U.S. Application Data**

(62) Division of application No. 29/141,588, filed on May 10, 2001.

(30) **Foreign Application Priority Data**

Nov. 10, 2000 (JP) ..... 2000-032241  
Nov. 10, 2000 (JP) ..... 2000-032242  
Nov. 10, 2000 (JP) ..... 2000-032243

(51) **LOC (7) Cl.** ..... **18-02**

(52) **U.S. Cl.** ..... **D18/56; 347/86**

(58) **Field of Search** ..... **D18/56, 44; 347/86,**  
**347/87**

(56) **References Cited**

**U.S. PATENT DOCUMENTS**

D321,900 S \* 11/1991 Kumagai ..... D18/56  
D331,939 S 12/1992 Ujita  
D334,403 S \* 3/1993 Kawakami ..... D18/56  
D419,592 S \* 1/2000 Nakazawa et al. .... D18/56  
6,053,606 A \* 4/2000 Yamaguchi et al. .... 347/86

D447,169 S \* 8/2001 Okubo et al. .... D18/56  
D447,513 S \* 9/2001 Miyazawa et al. .... D18/56  
D449,642 S 10/2001 Yamada et al.

\* cited by examiner

*Primary Examiner*—Cathy Anne MacCormac

(74) *Attorney, Agent, or Firm*—Oliff & Berridge, PLC

(57) **CLAIM**

The ornamental design for an ink cartridge, as shown and described.

**DESCRIPTION**

FIG. 1 is a top view of an ink cartridge;  
FIG. 2 is a bottom view thereof;  
FIG. 3 is a left-side view thereof;  
FIG. 4 is a right-side view thereof;  
FIG. 5 is a front view thereof;  
FIG. 6 is a rear view thereof;  
FIG. 7 is a cross-sectional view thereof, taken along the lines 7—7 of FIG. 2;  
FIG. 8 is a cross-sectional view thereof; taken along the lines 8—8 of FIG. 4;  
FIG. 9 is a cross-sectional view thereof, taken along the lines 9—9 of FIG. 4;  
FIG. 10 is a cross-sectional view thereof, taken along the lines 10—10 of FIG. 4;  
FIG. 11 is a perspective view thereof; and,  
FIG. 12 is another perspective view thereof.

The broken line showing is for illustrative purposes only and forms no part of the claimed design.

**1 Claim, 7 Drawing Sheets**

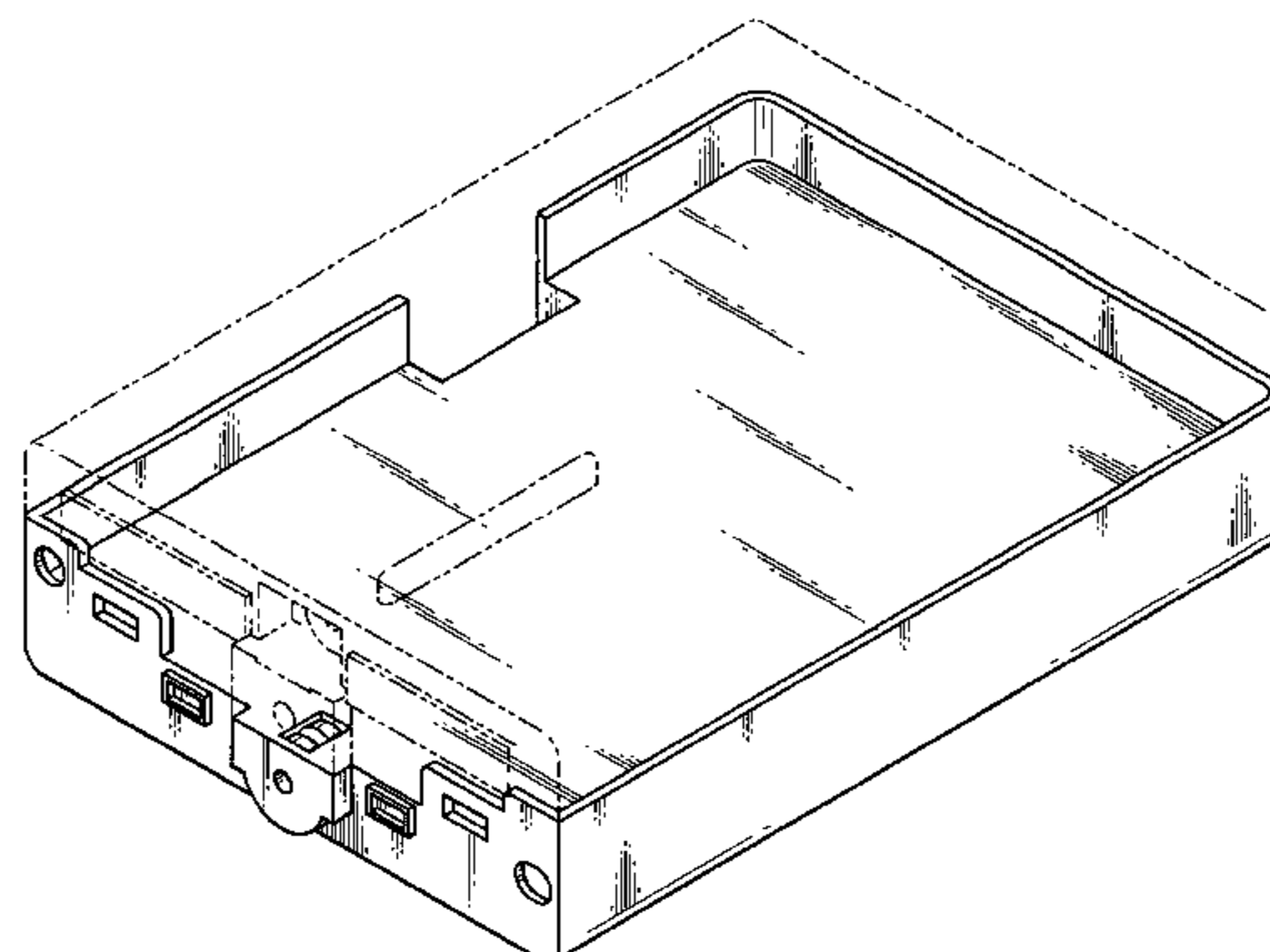
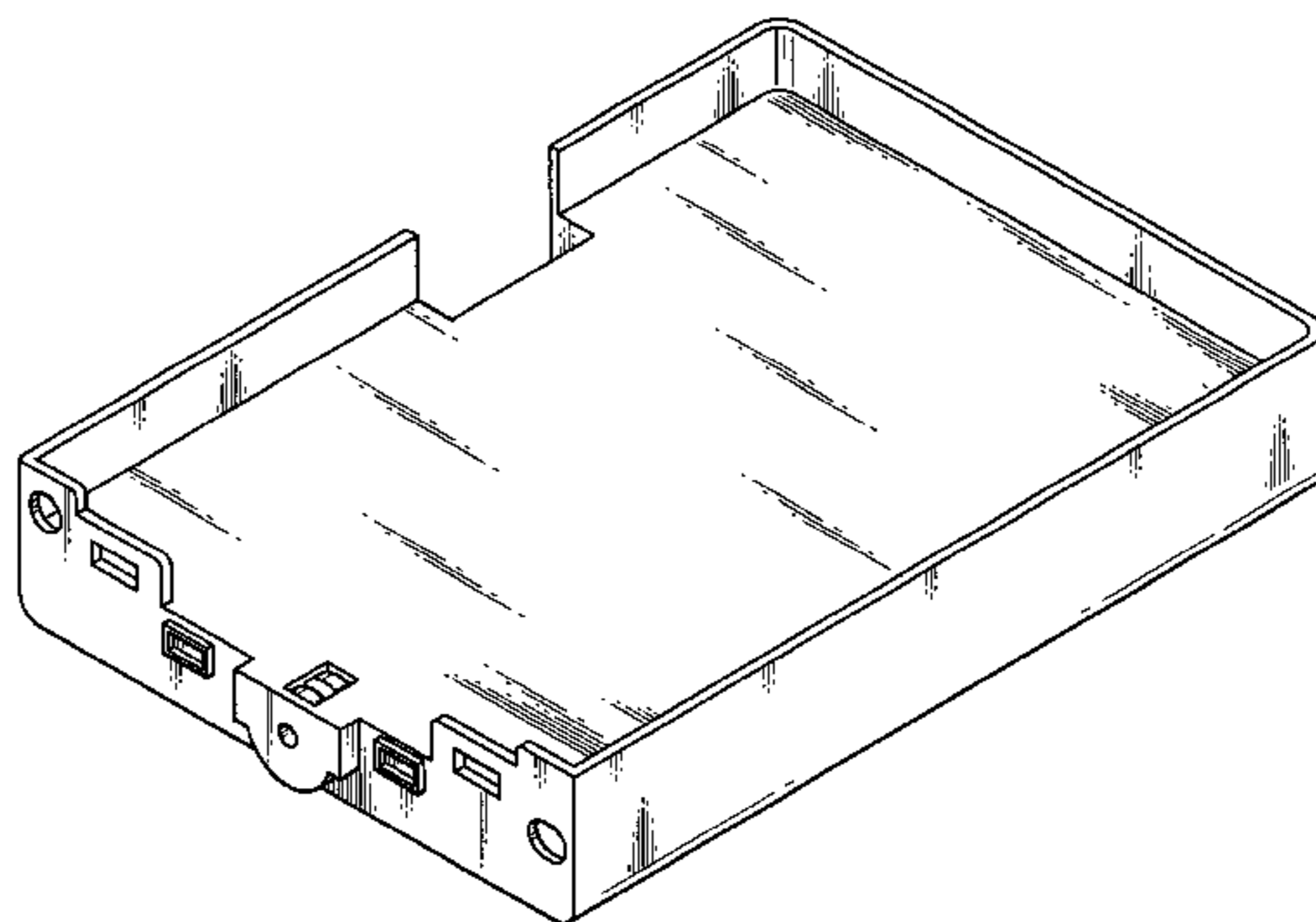

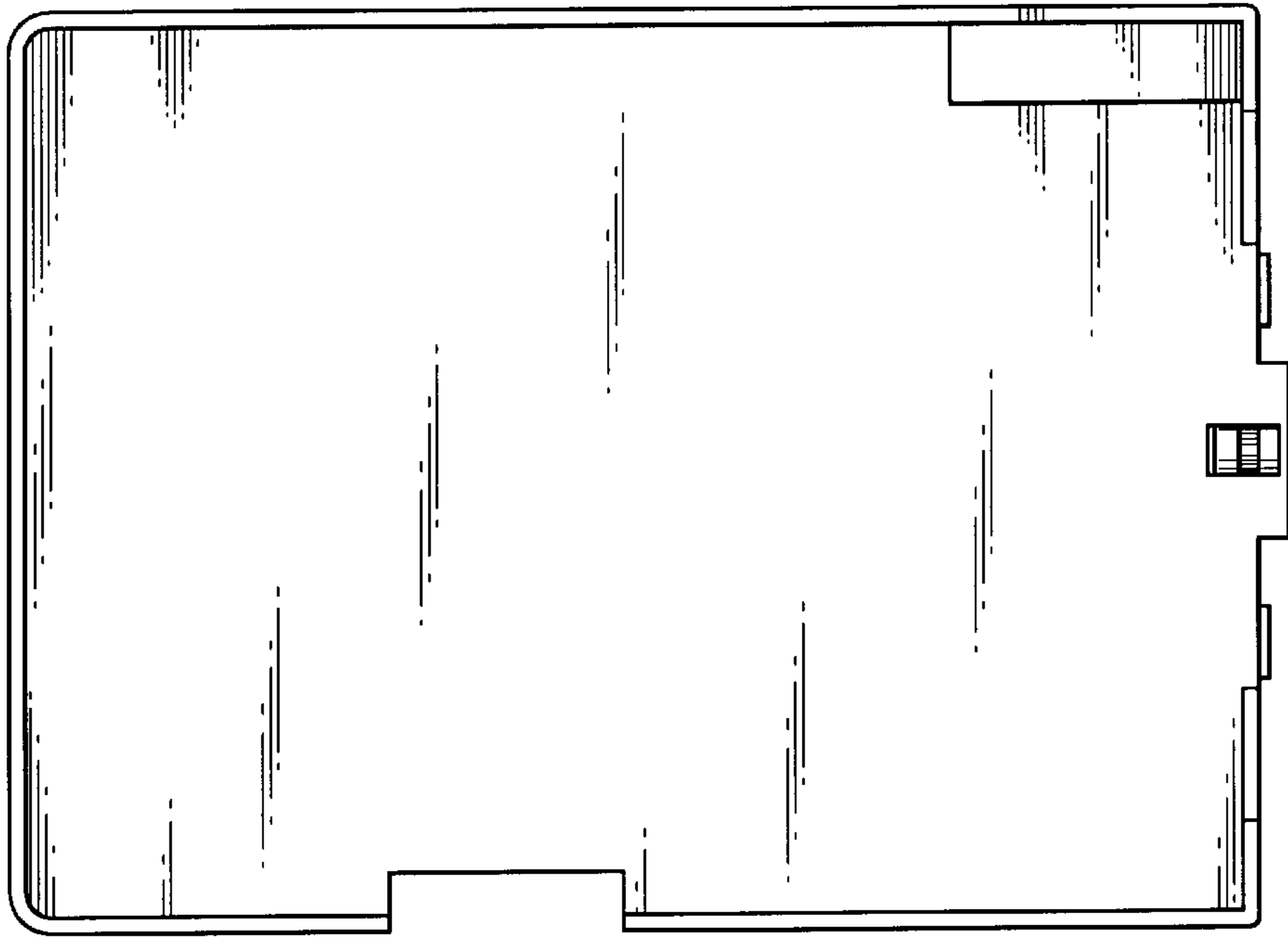

Fig. 1

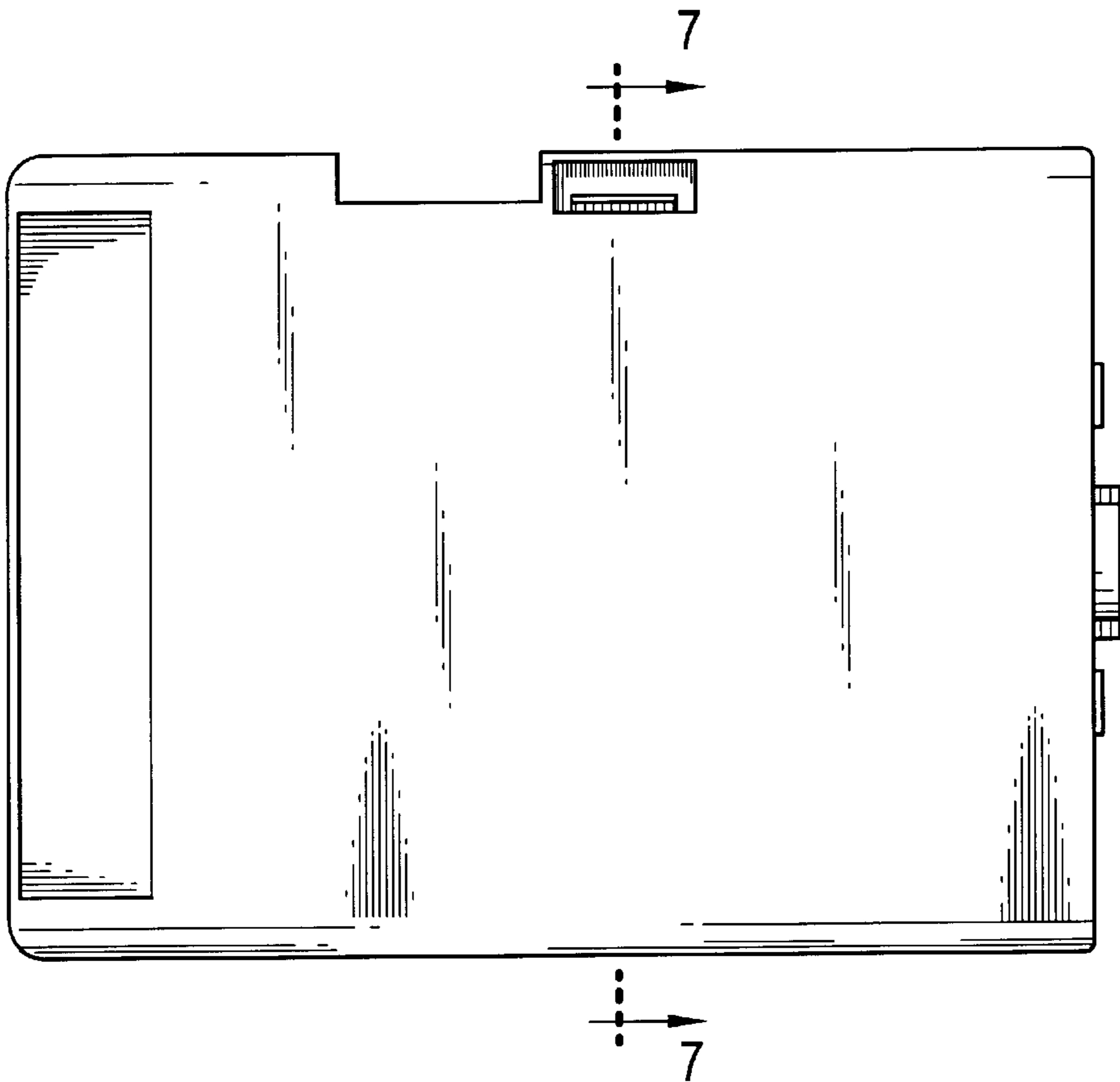

Fig. 2

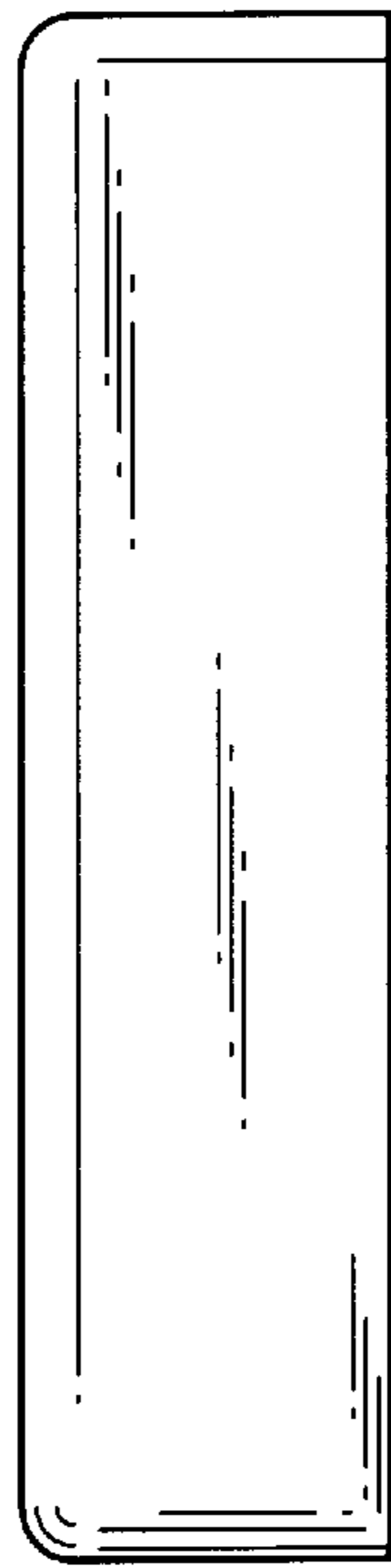

Fig. 3

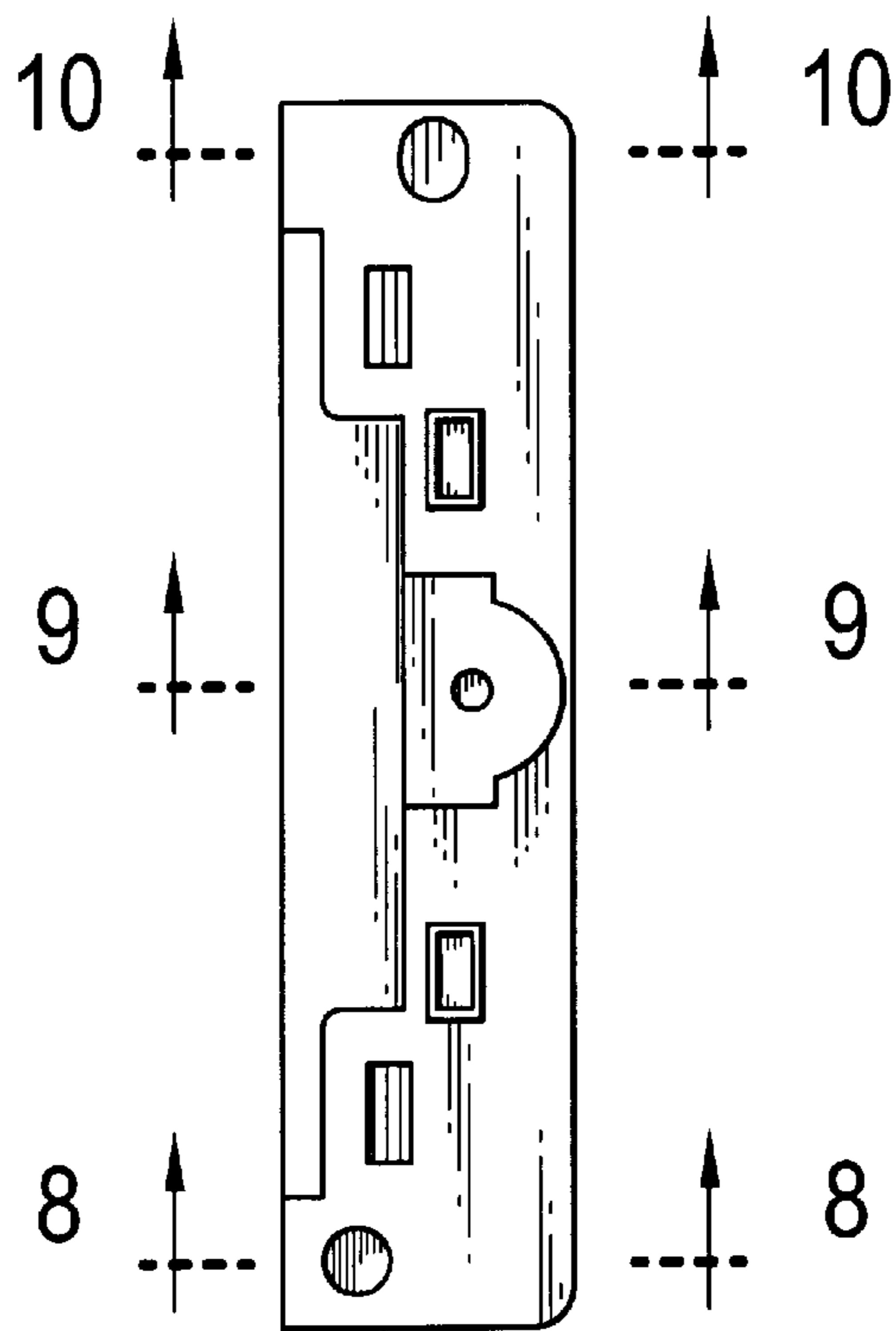

Fig. 4

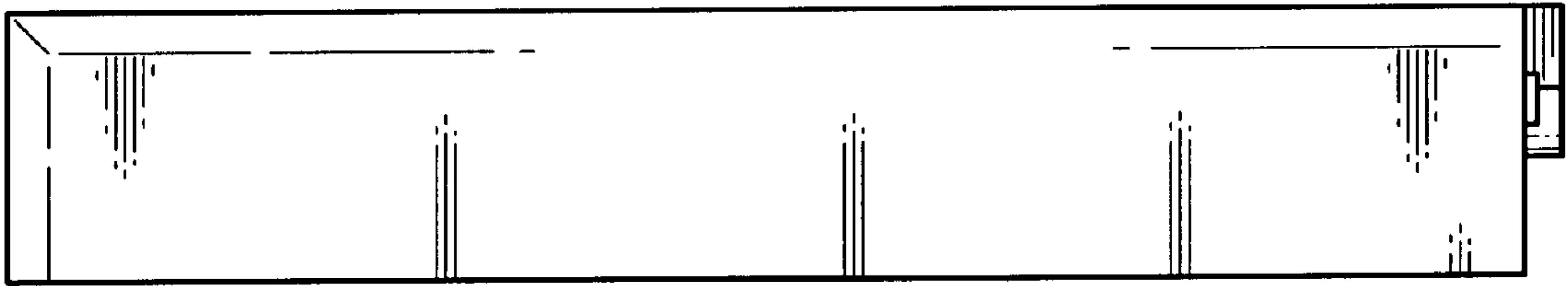

Fig. 5

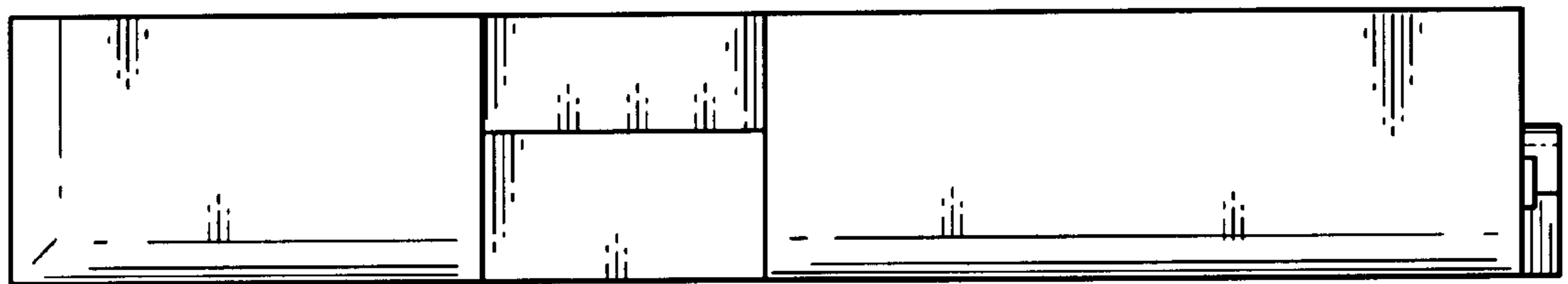

Fig. 6

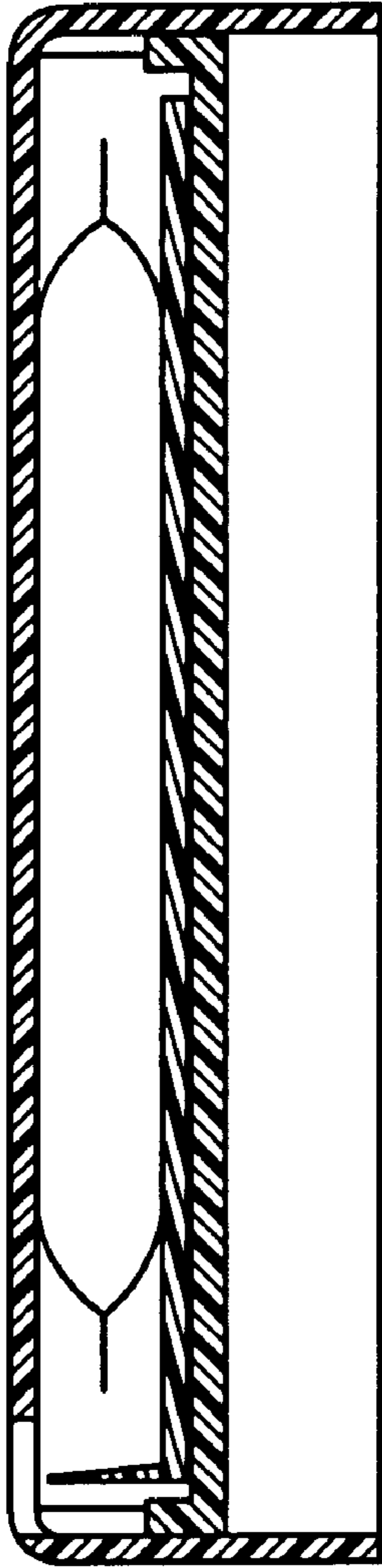

Fig. 7

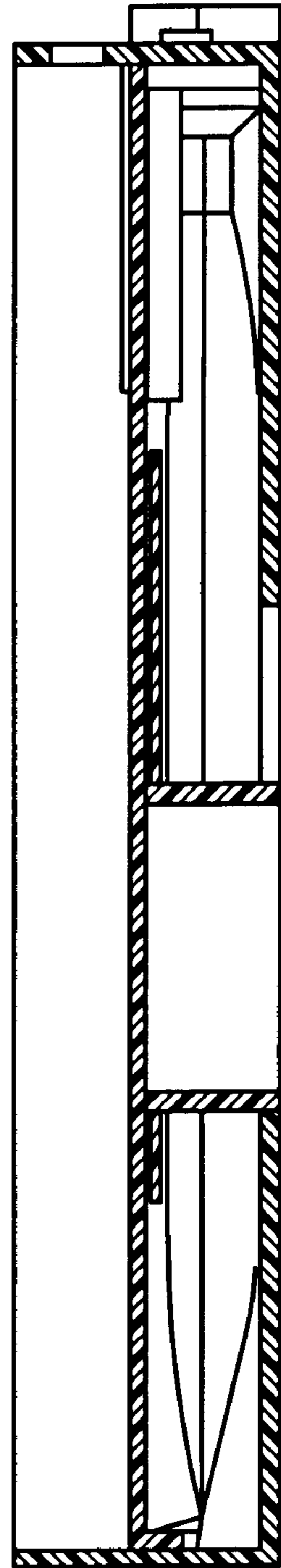

Fig. 8

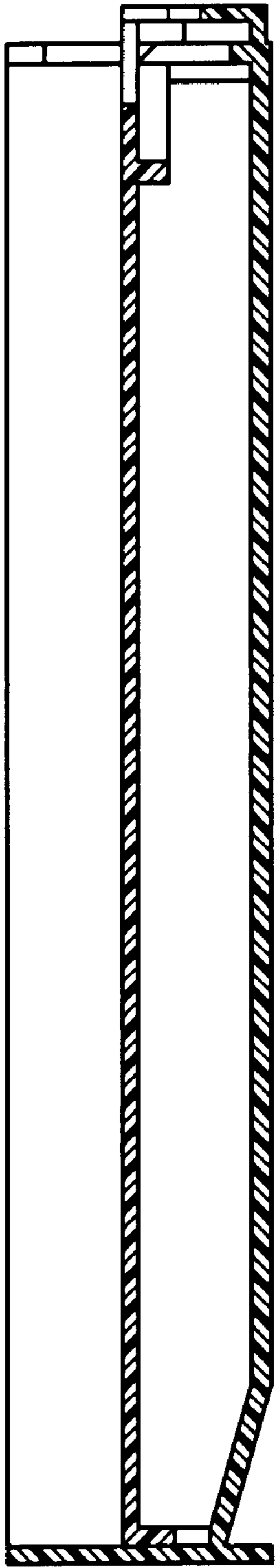

Fig. 9

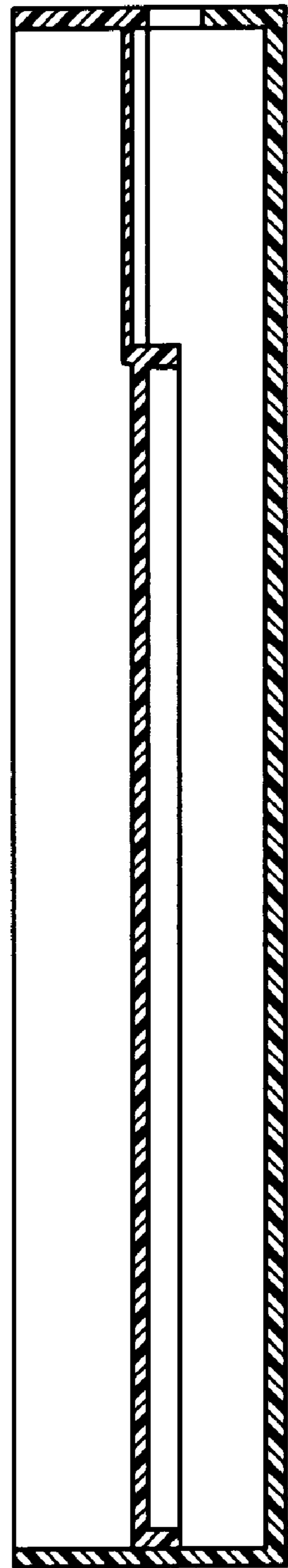

Fig. 10

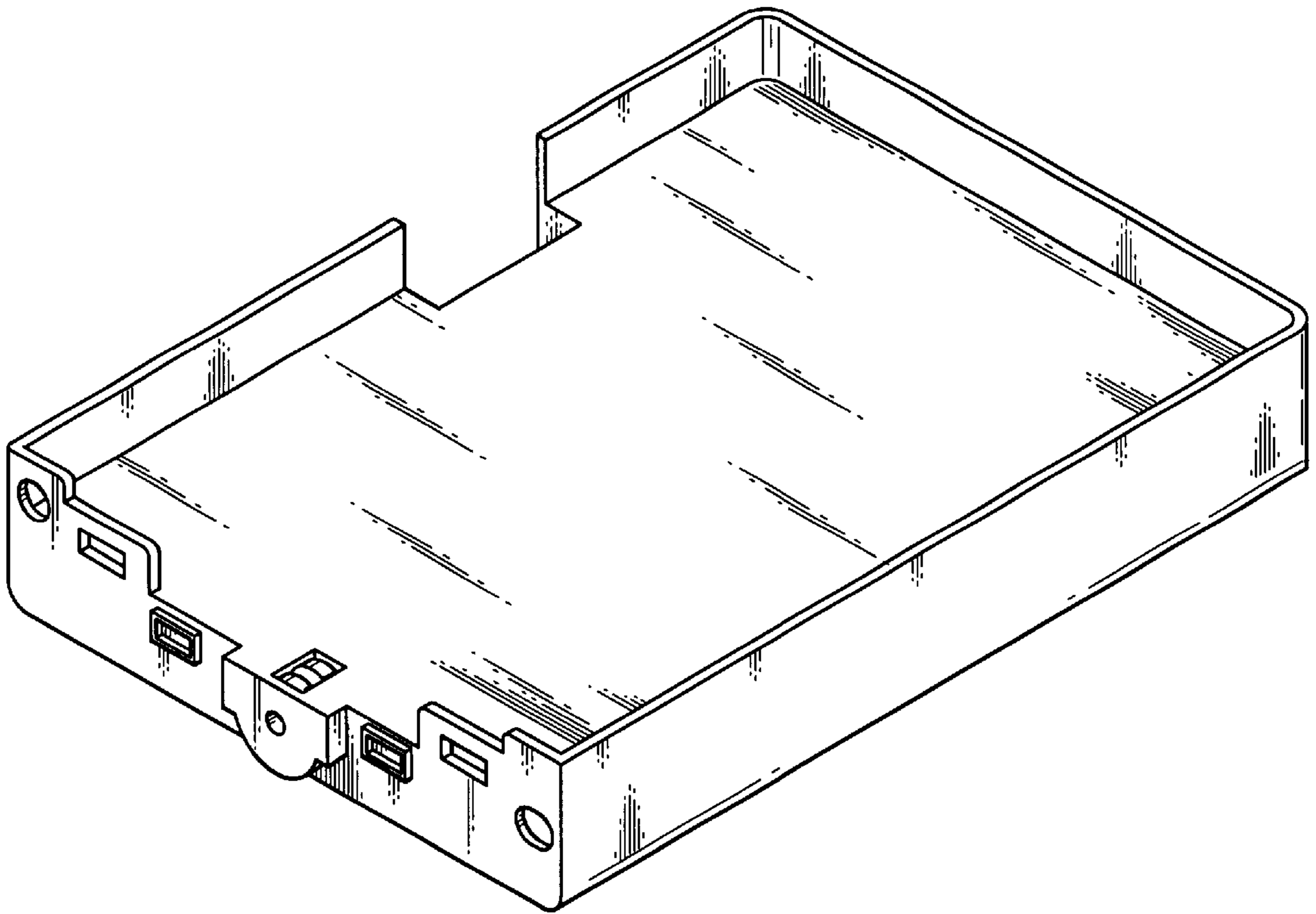

Fig. 11

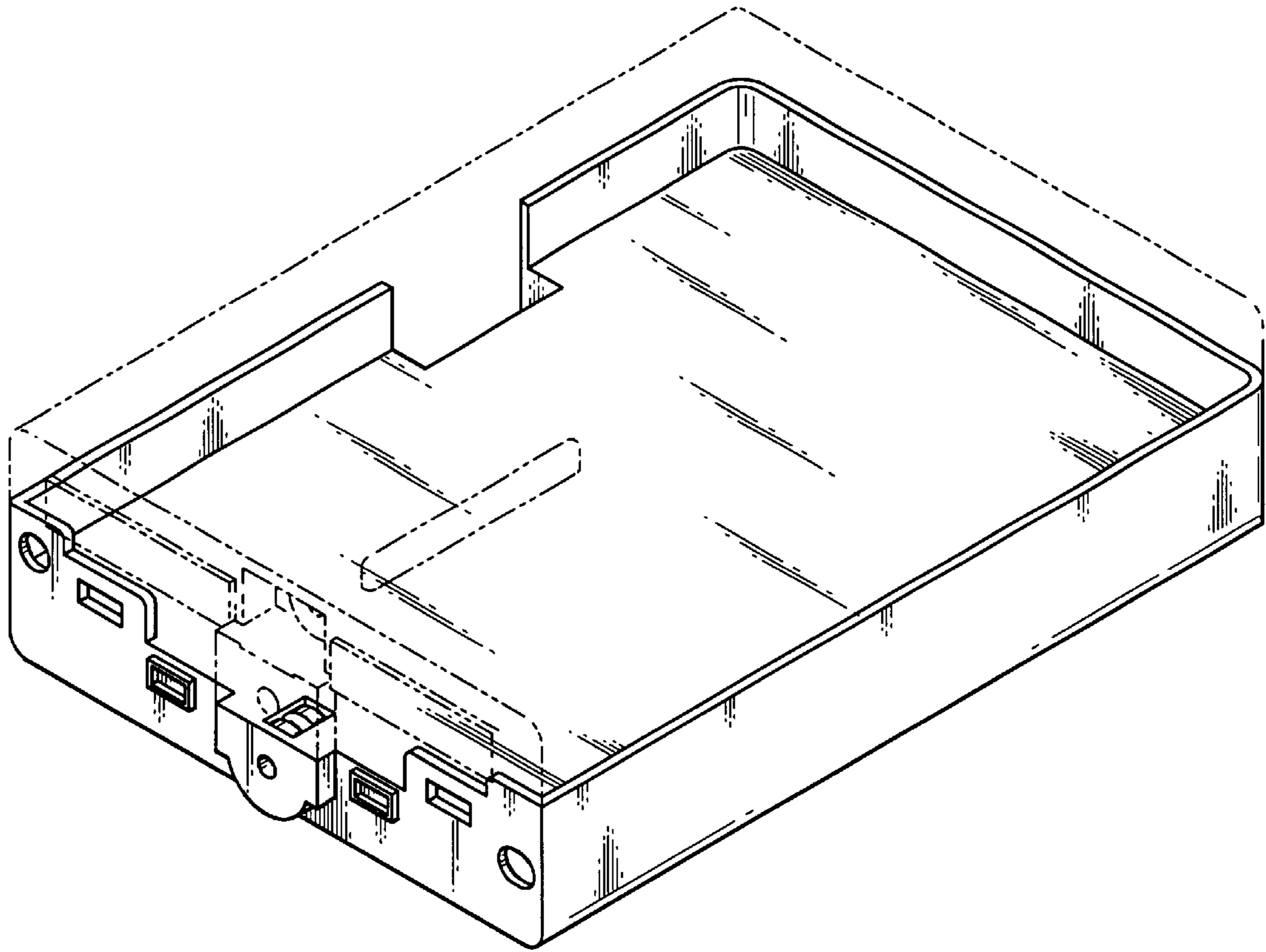

Fig. 12