



US00D468762S

(12) **United States Design Patent**  
**Kurita et al.**

(10) **Patent No.:** **US D468,762 S**

(45) **Date of Patent:** **\*\* Jan. 14, 2003**

(54) **COMPOSITE DIGITAL COLOR PRINTER/  
COPY MACHINE**

(75) Inventors: **Masahiro Kurita**, Kanagawa (JP);  
**Masaaki Kabumoto**, Chiba (JP)

(73) Assignee: **Ricoh Company, Ltd.**, Tokyo (JP)

(\*\*) Term: **14 Years**

(21) Appl. No.: **29/155,451**

(22) Filed: **Feb. 12, 2002**

(30) **Foreign Application Priority Data**

Aug. 20, 2001 (JP) ..... 2001-024359

(51) **LOC (7) Cl.** ..... **16-03**

(52) **U.S. Cl.** ..... **D18/39**

(58) **Field of Search** ..... D18/36-39; 399/1-7,  
399/81, 130; 355/97

(56) **References Cited**

**U.S. PATENT DOCUMENTS**

D404,419 S \* 1/1999 Kusanagi ..... D18/39

D433,439 S \* 11/2000 Yoshida et al. .... D18/36  
D438,559 S \* 3/2001 Matsumoto et al. .... D18/39  
D447,765 S \* 9/2001 Hatanaka et al. .... D18/39  
D458,298 S \* 6/2002 Katsuyama et al. .... D18/36

\* cited by examiner

*Primary Examiner*—Caron D. Veynar

(74) *Attorney, Agent, or Firm*—Dickstein Shapiro Morin &  
Oshinsky LLP

(57) **CLAIM**

The ornamental design for a composite digital color printer/  
copy machine, as shown.

**DESCRIPTION**

FIG. 1 is a front elevation of a composite digital color  
printer/copy machine;  
FIG. 2 is a rear elevation view thereof;  
FIG. 3 is a top plan view thereof;  
FIG. 4 is a bottom plan view thereof;  
FIG. 5 is a right side elevation thereof;  
FIG. 6 is a left side elevation thereof; and,  
FIG. 7 is a top, front and right side perspective view thereof.

**1 Claim, 6 Drawing Sheets**

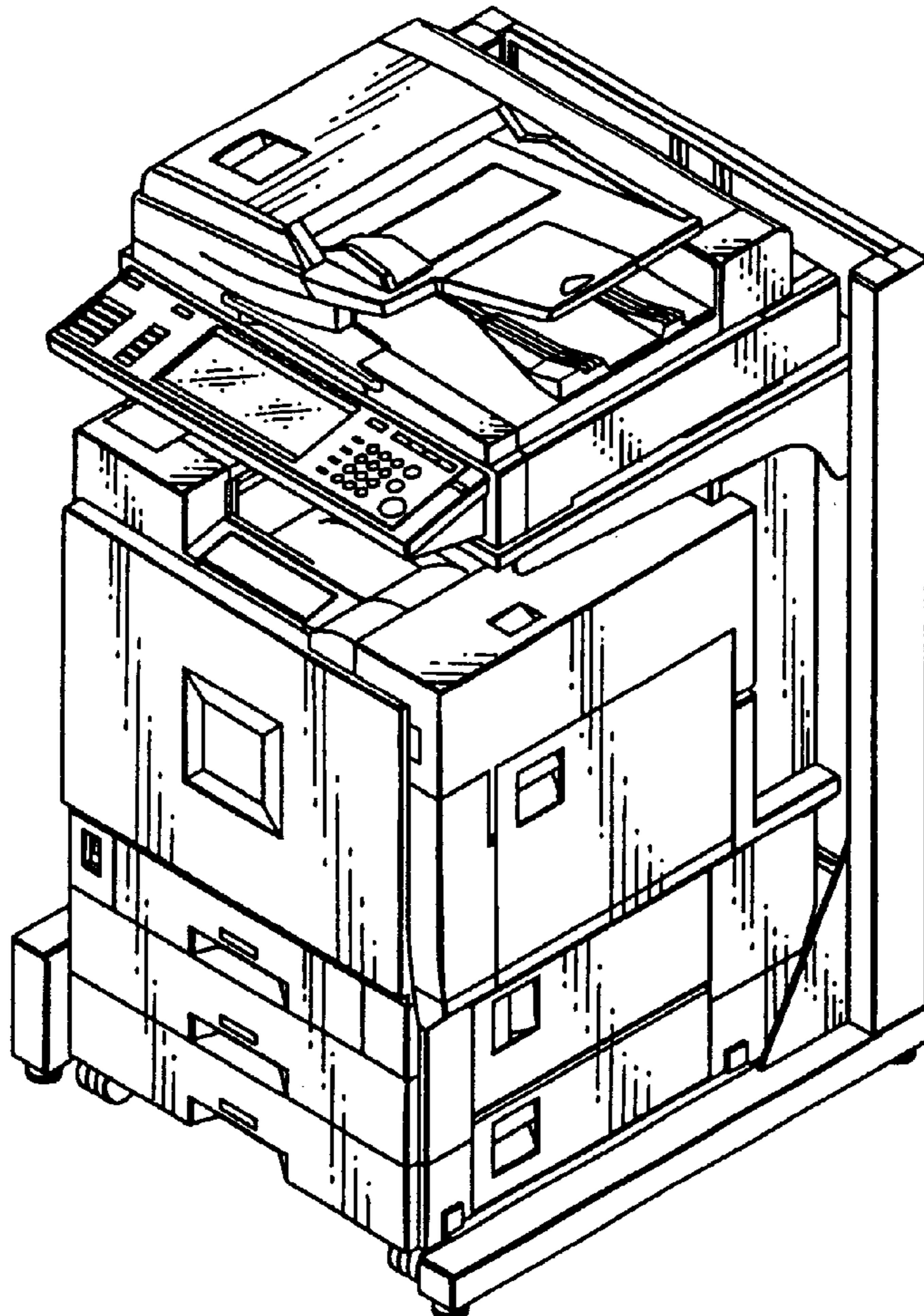

FIG. 1

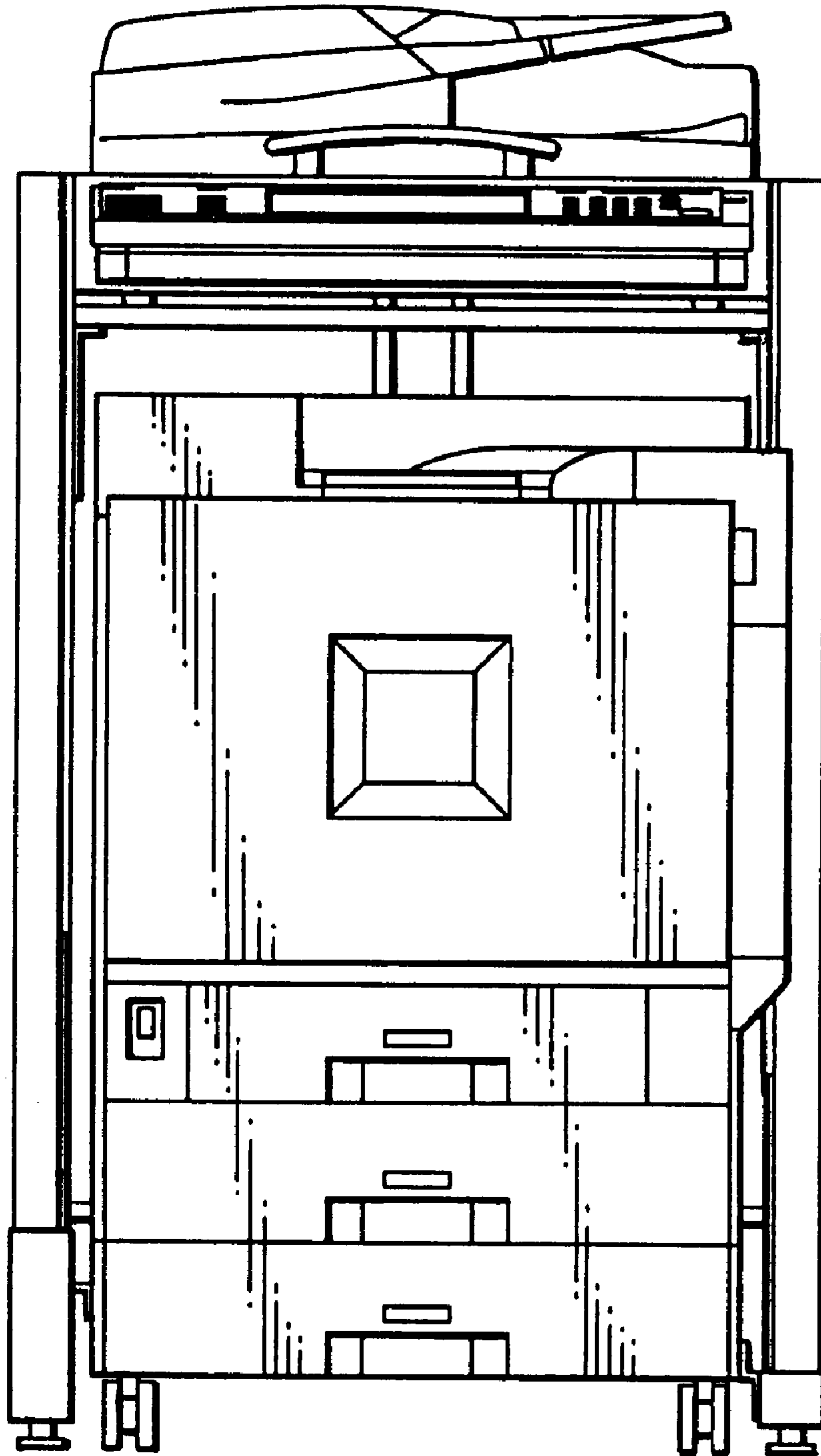

FIG. 2

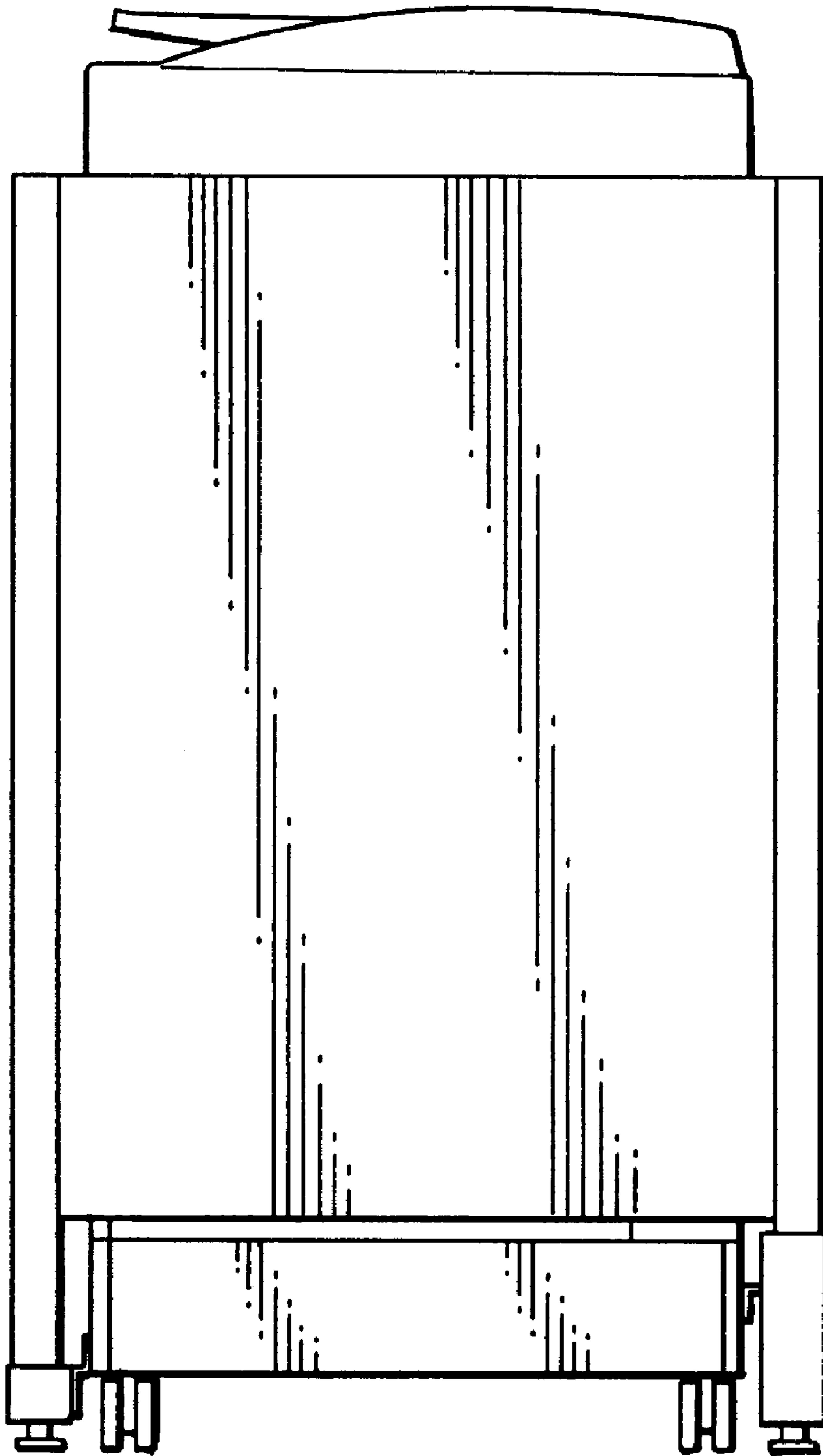

FIG. 3

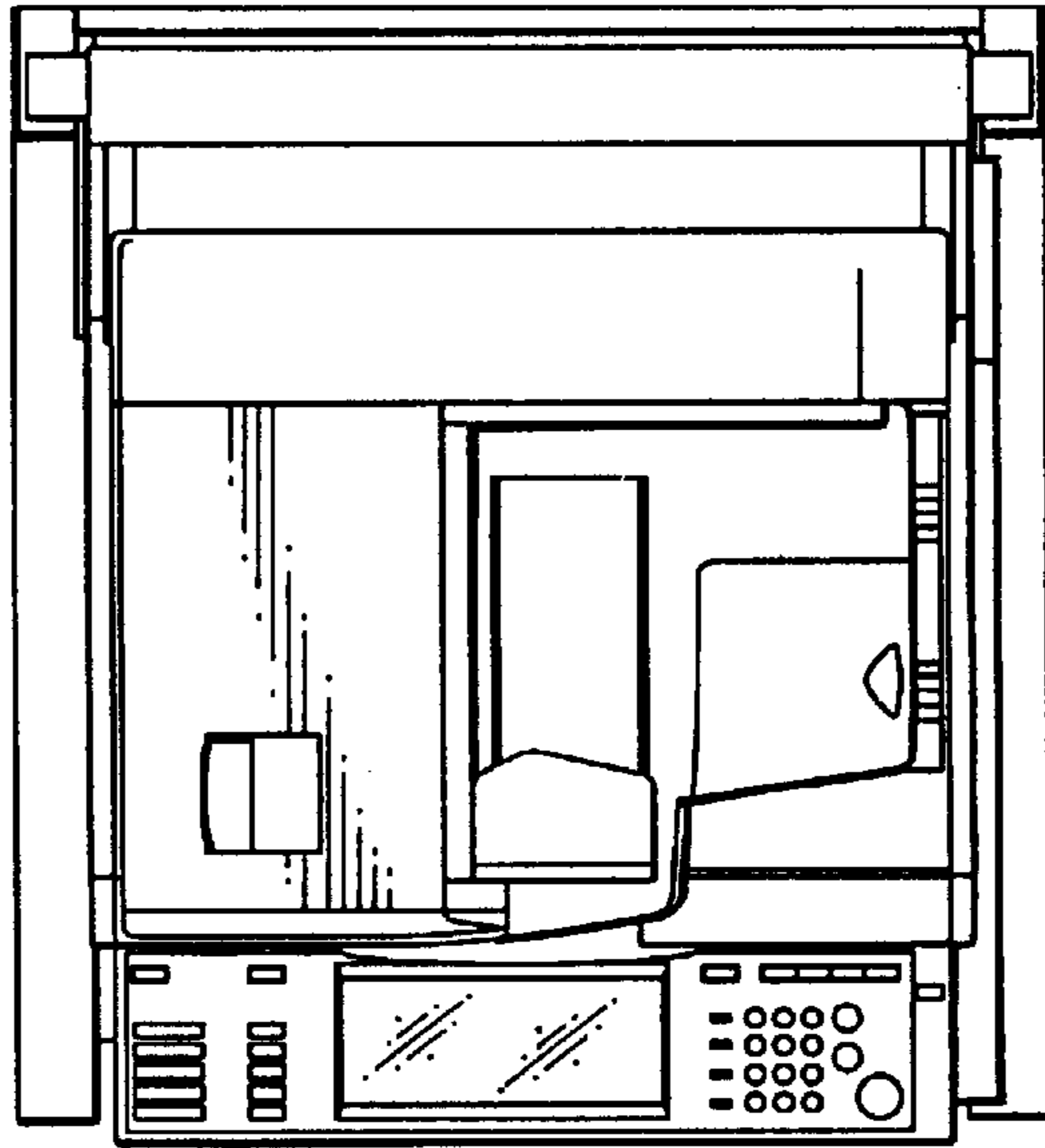

FIG. 4

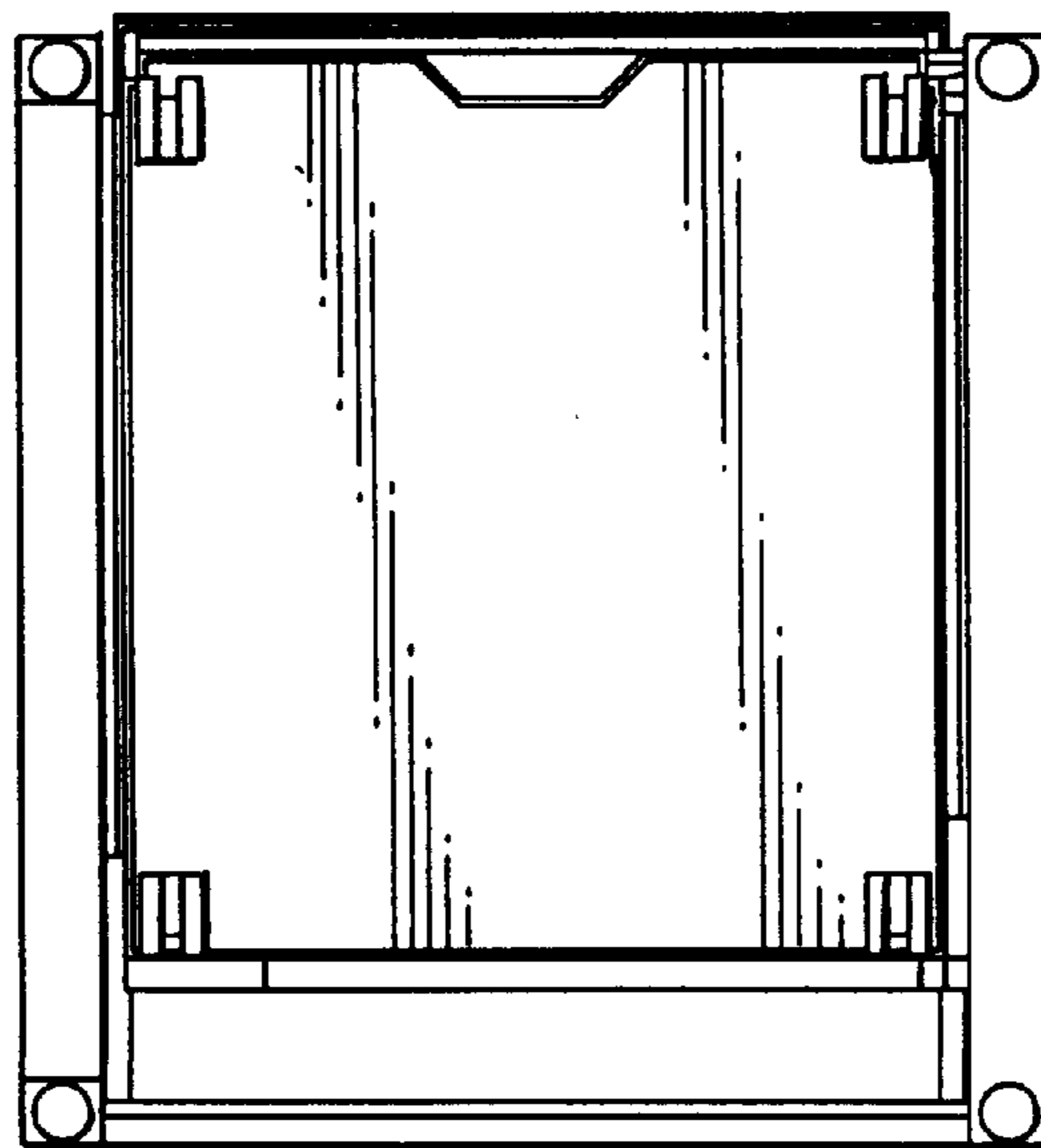

FIG. 5

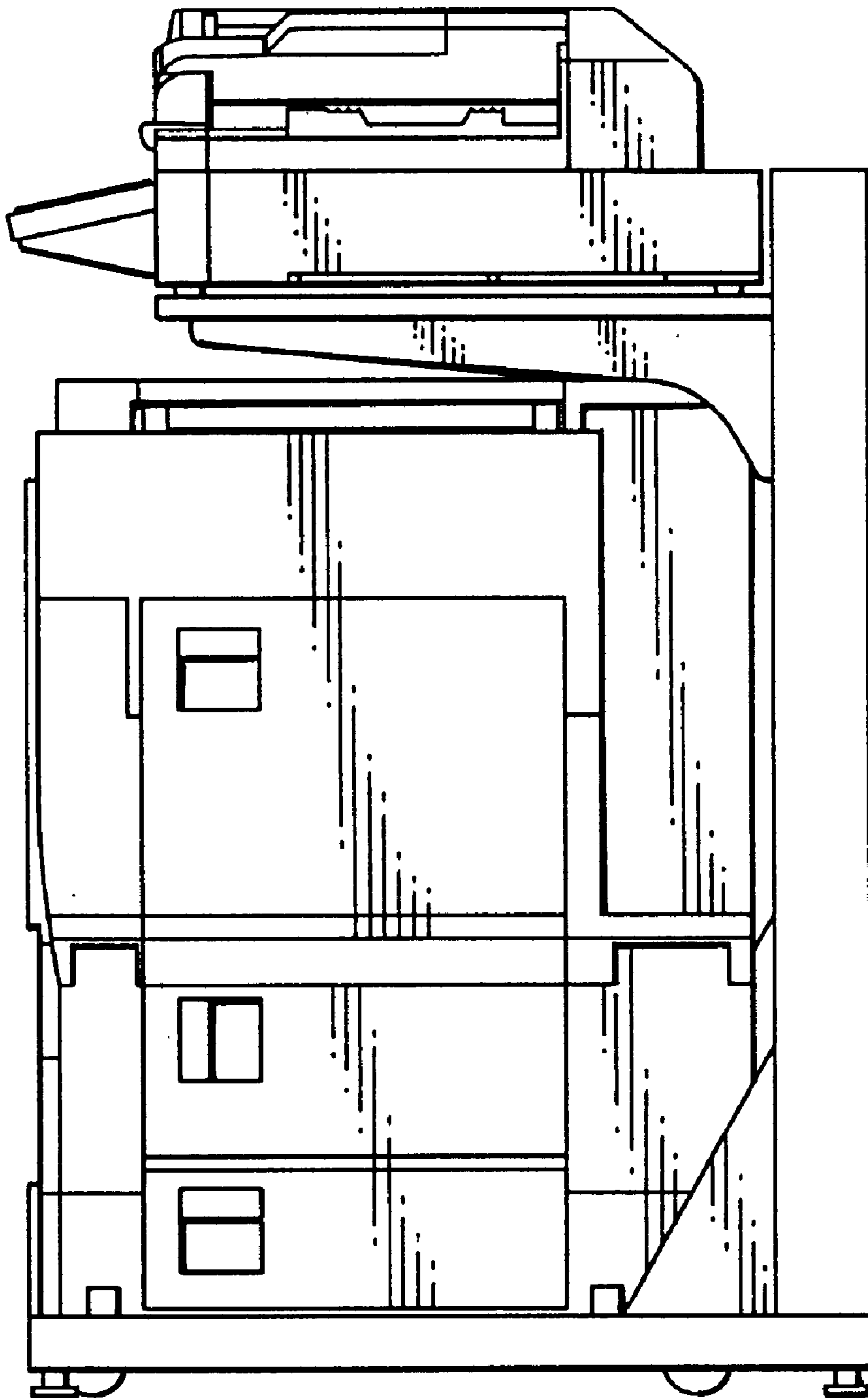

FIG. 6

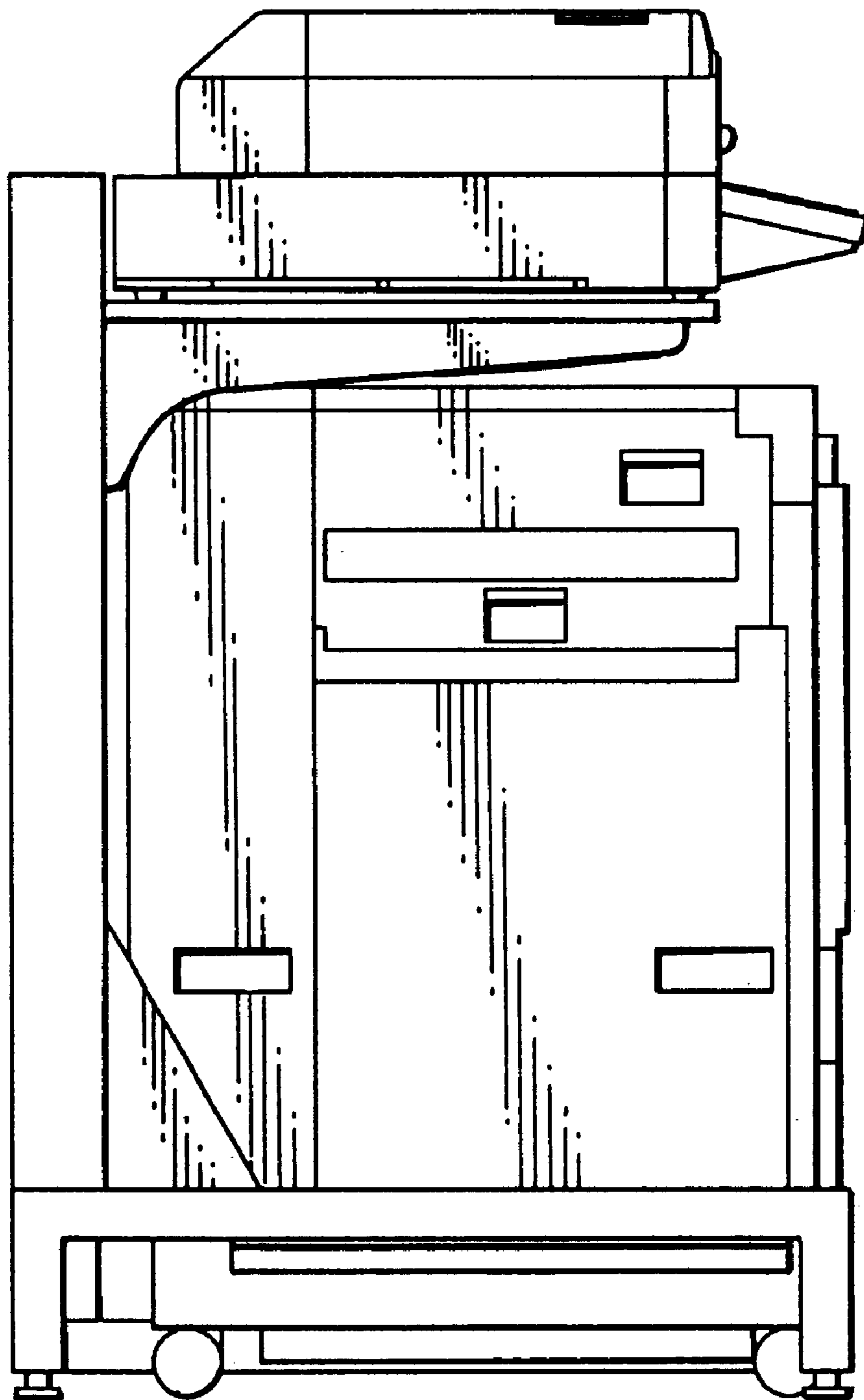



FIG. 7

