



US00D468605S

(12) **United States Design Patent**
Morgan

(10) **Patent No.:** **US D468,605 S**

(45) **Date of Patent:** **** Jan. 14, 2003**

(54) **PNEUMATIC TOOL**

(75) **Inventor:** **Fred M. Morgan**, Jackson, TN (US)

(73) **Assignee:** **DeVilbiss Air Power Company**,
Jackson, TN (US)

(**) **Term:** **14 Years**

(21) **Appl. No.:** **29/149,145**

(22) **Filed:** **Oct. 3, 2001**

(51) **LOC (7) Cl.** **08-04**

(52) **U.S. Cl.** **D8/61**

(58) **Field of Search** D8/25, 61, 62,
D8/83, DIG. 7; 60/695; 81/57.13, 57.26,
57.29, 57.39, 57.42, 62, 63, 63.1, 63.2,
429, 463, 464, 467, 469, 470; 173/29, 93,
104, 168, 169, 170, 178, 216, 217; 310/50

(56) **References Cited**

U.S. PATENT DOCUMENTS

D269,847 S * 7/1983 Izumisawa D8/62
4,411,173 A * 10/1983 Mixer 173/117

4,708,210 A * 11/1987 Rahm 173/170
5,941,764 A * 8/1999 Yang 451/358
6,158,528 A * 12/2000 Izumisawa 173/168
6,298,753 B1 * 10/2001 Izumisawa 81/57.39

* cited by examiner

Primary Examiner—Doris V. Coles

Assistant Examiner—Elizabeth Albert

(74) *Attorney, Agent, or Firm*—Suiter & Associates PC

(57) **CLAIM**

We claim the ornamental design for a pneumatic tool, as shown.

DESCRIPTION

FIG. 1 is a top plan view of a pneumatic tool showing my new design;

FIG. 2 is a front elevation view thereof;

FIG. 3 is a left side elevation view thereof;

FIG. 4 is a rear elevation view thereof;

FIG. 5 is a right side elevation view thereof; and,

FIG. 6 is a bottom plan view thereof.

1 Claim, 1 Drawing Sheet

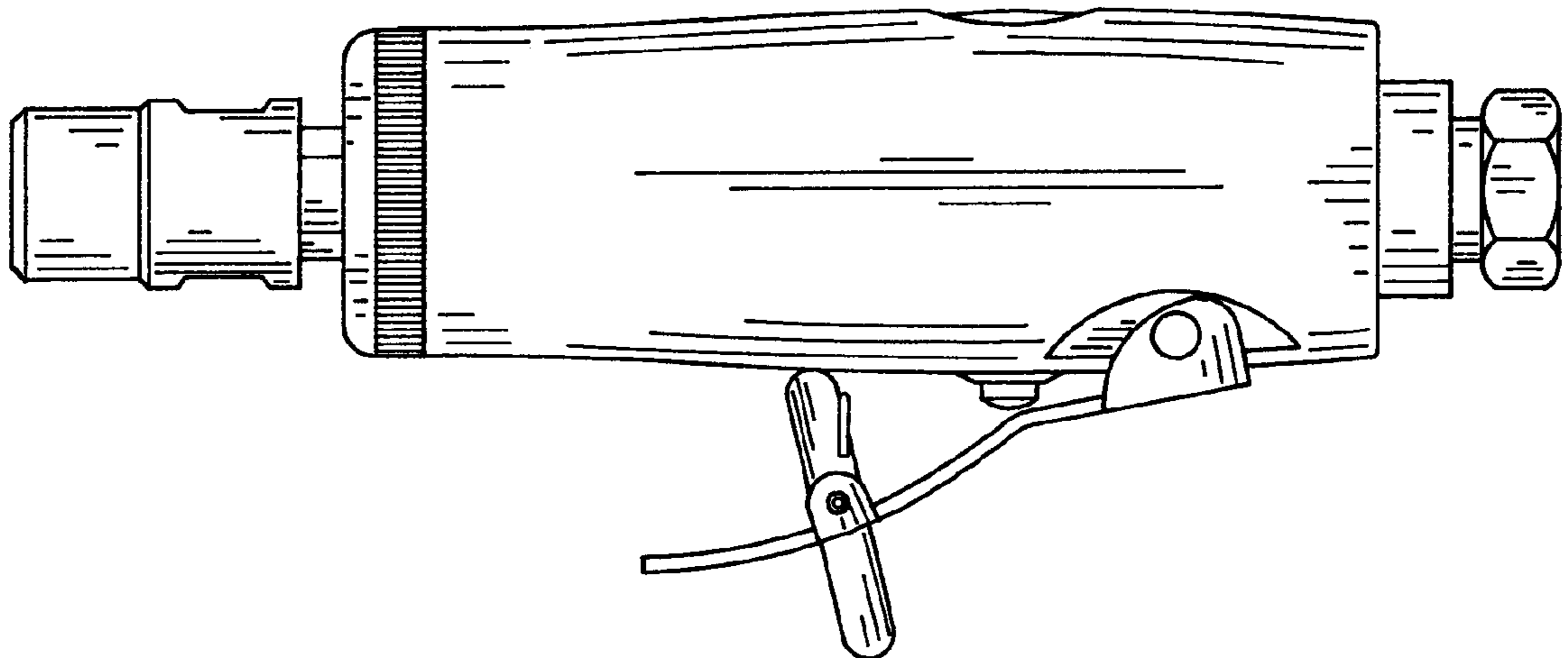

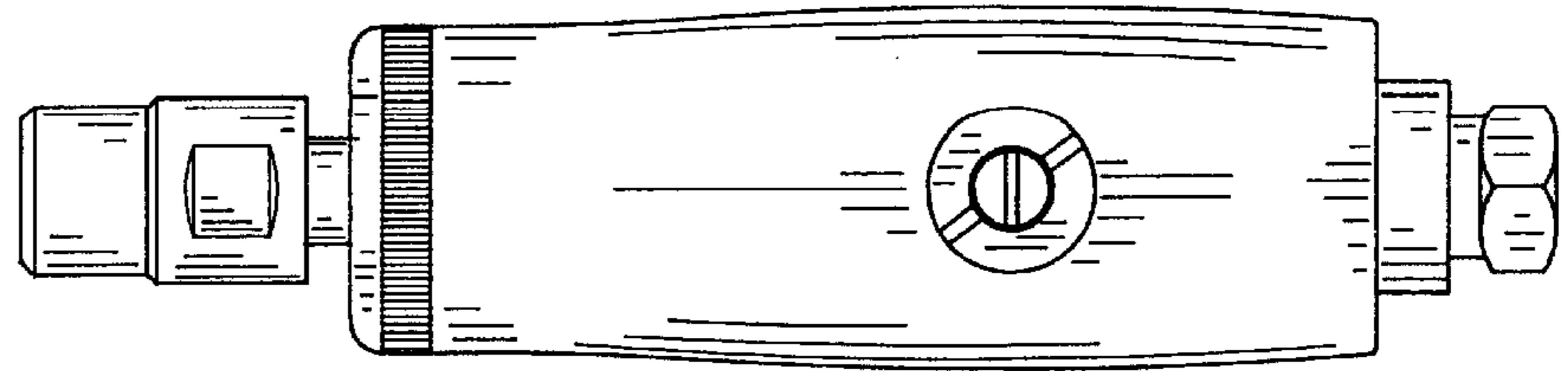

FIG. 1

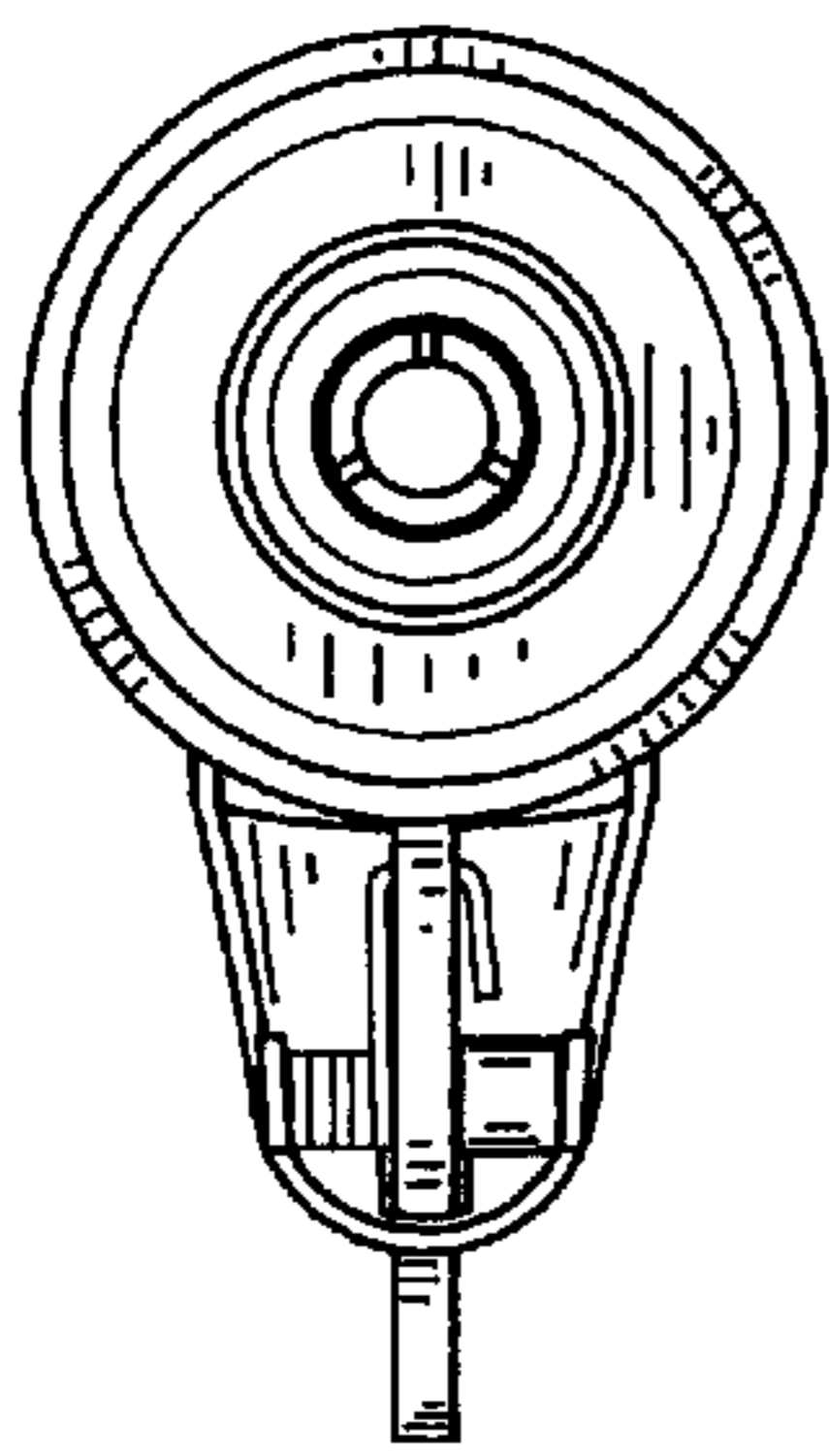

FIG. 2

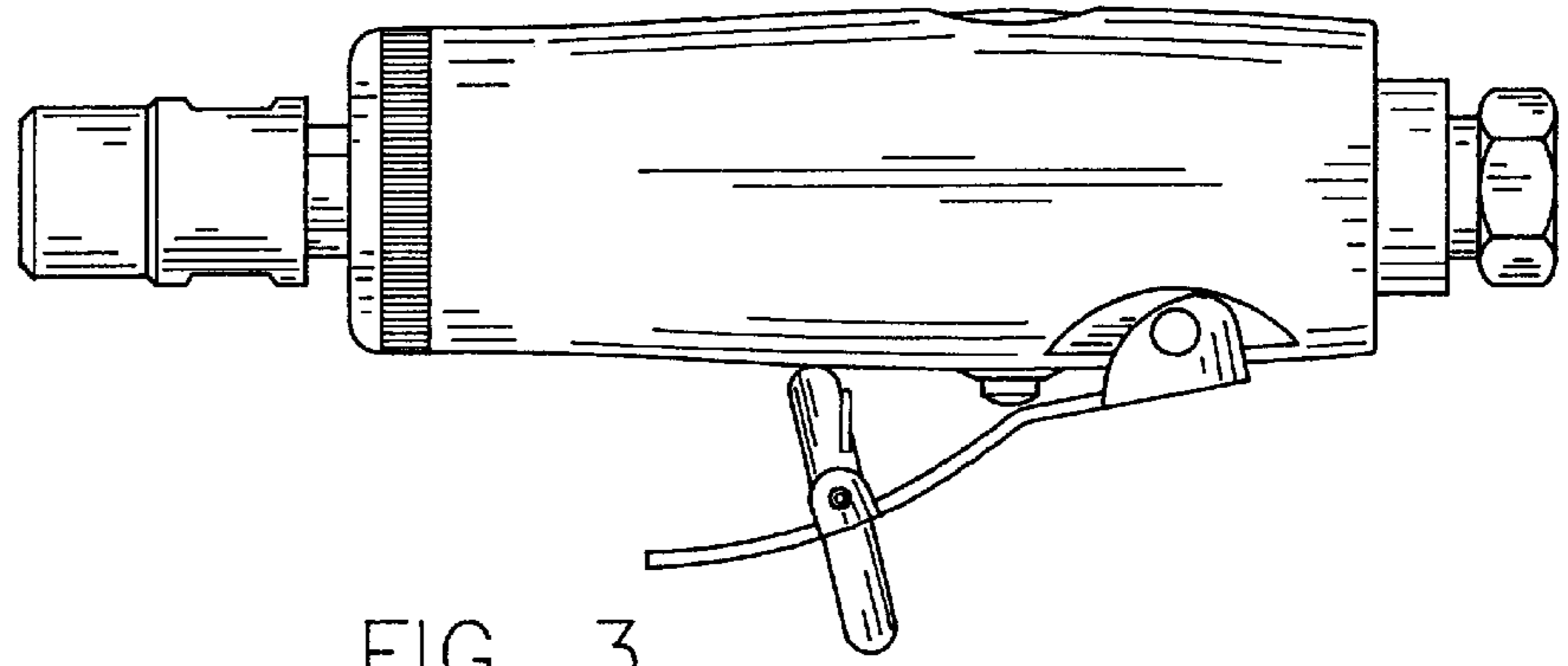

FIG. 3

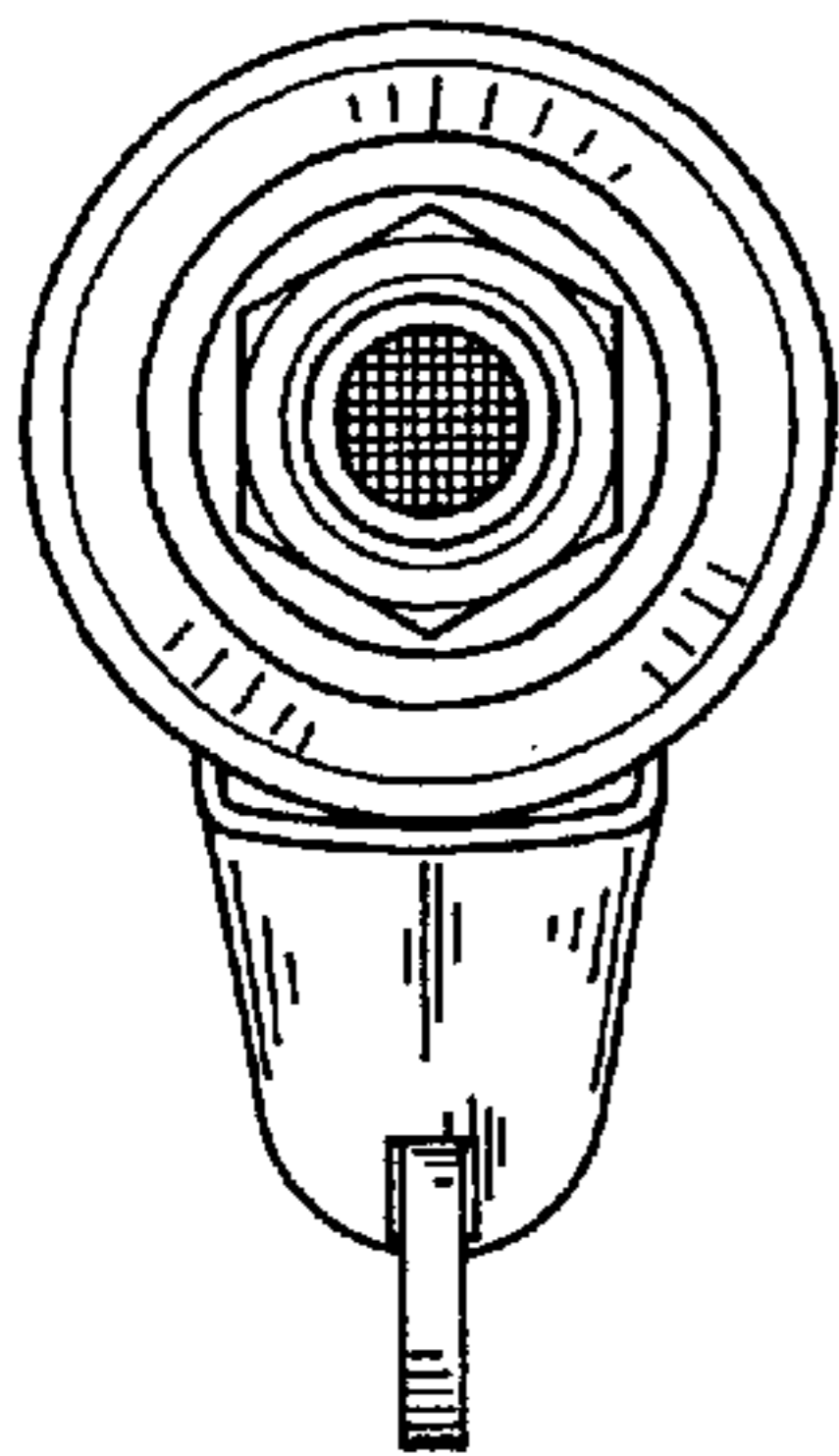

FIG. 4

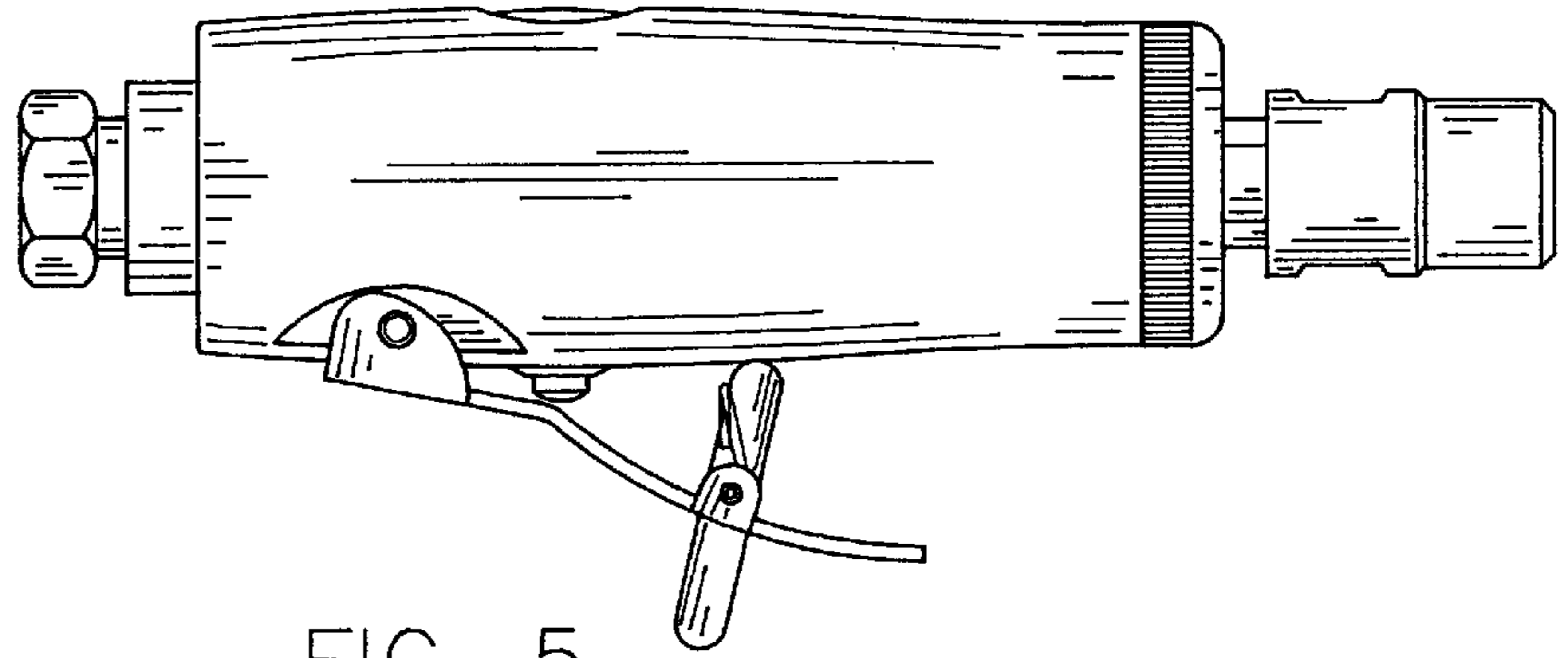

FIG. 5

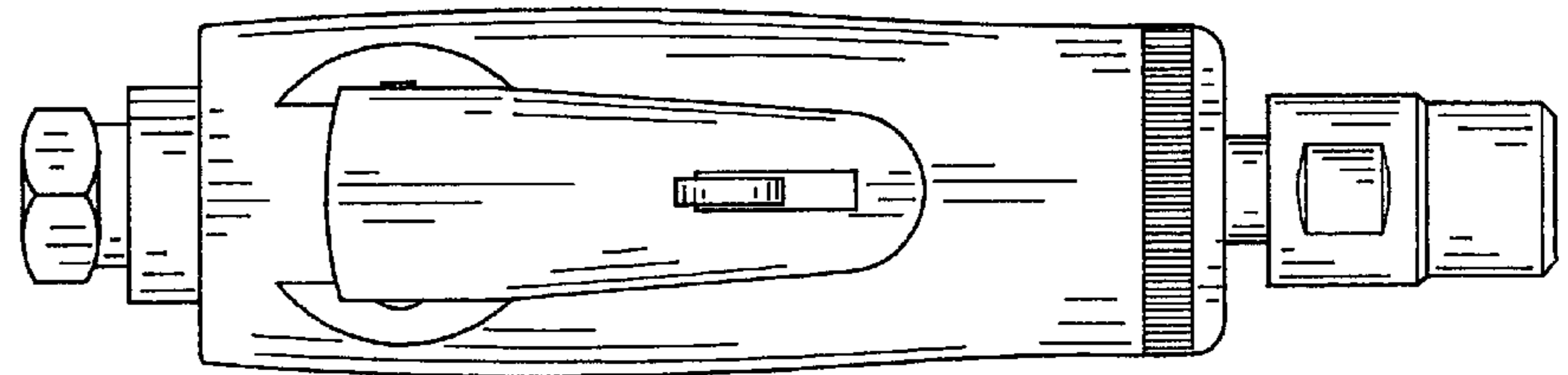

FIG. 6