



US00D468381S

(12) **United States Design Patent**  
**Parker**

(10) **Patent No.:** **US D468,381 S**

(45) **Date of Patent:** **\*\* Jan. 7, 2003**

(54) **GOLF PUTTER**

D425,951 S \* 5/2000 Davis et al. .... D21/736

(76) Inventor: **Tony S. Parker**, 216 Metz St., Ruidoso,  
NM (US) 88345

\* cited by examiner

*Primary Examiner*—Mitchell Siegel

(\*\*) Term: **14 Years**

(57) **CLAIM**

(21) Appl. No.: **29/154,312**

The ornamental design for a golf putter, as shown and described.

(22) Filed: **Jan. 24, 2002**

**DESCRIPTION**

(51) **LOC (7) Cl.** ..... **21-02**

FIG. 1 is a left side view of a golf putter showing my new design.

(52) **U.S. Cl.** ..... **D21/738**

FIG. 2 is a right side view of the golf putter.

(58) **Field of Search** ..... D21/736-746;

FIG. 3 is a front view of the golf putter.

473/324, 327-331, 340, 341, 206, 295

FIG. 4 is a back view of the golf putter.

(56) **References Cited**

FIG. 5 is a top view of the golf putter.

**U.S. PATENT DOCUMENTS**

FIG. 6 is a bottom view of the golf putter; and,

D285,817 S \* 9/1986 Richardson ..... D21/738

FIG. 7 is a perspective view of the golf putter.

D358,187 S \* 5/1995 Simonds ..... D21/738

The broken away section is shown do to indeterminate length of the claimed design.

5,595,385 A \* 1/1997 Tablonski ..... 473/295

5,746,662 A \* 5/1998 Squire ..... 473/206

**1 Claim, 2 Drawing Sheets**

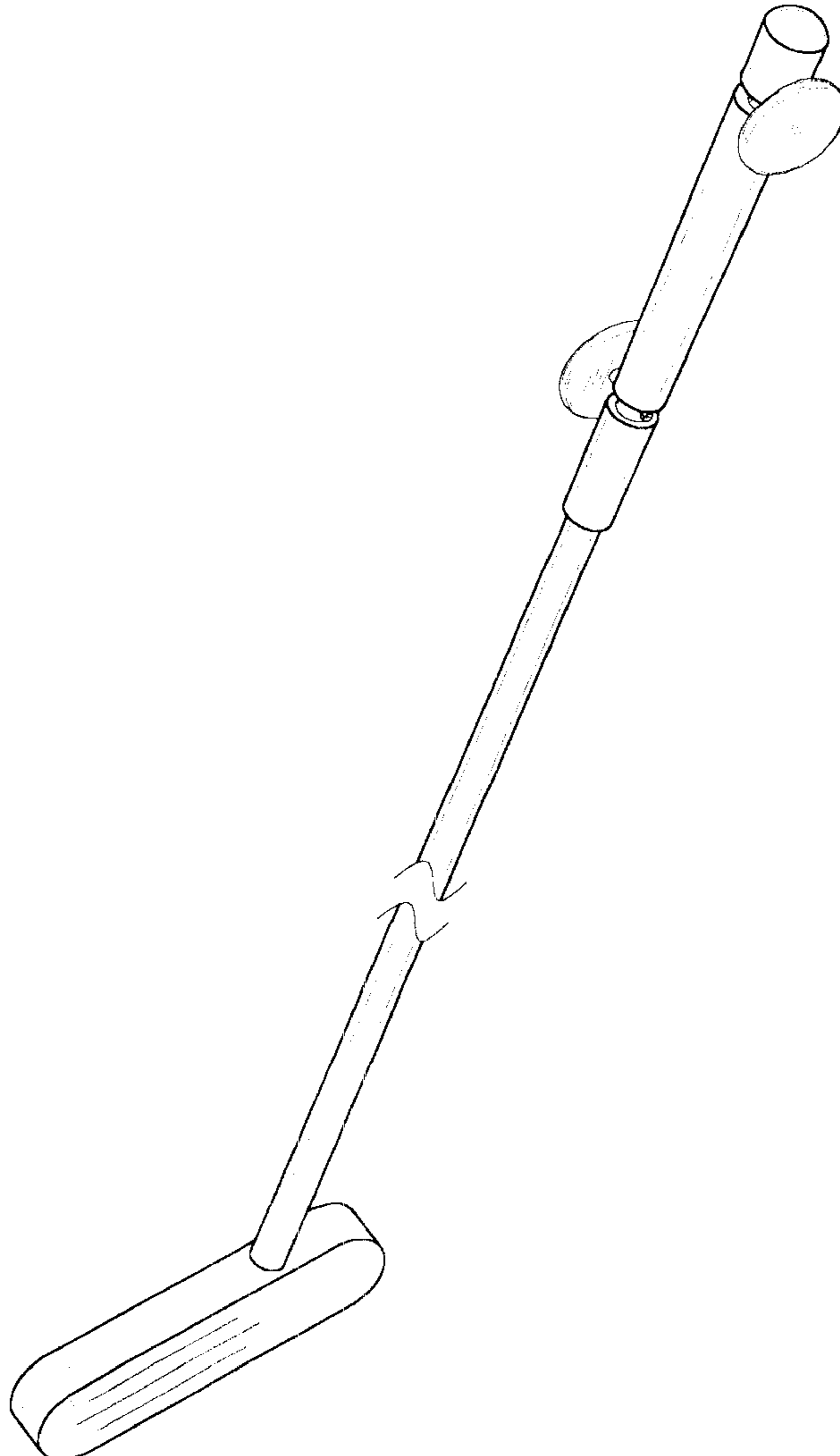

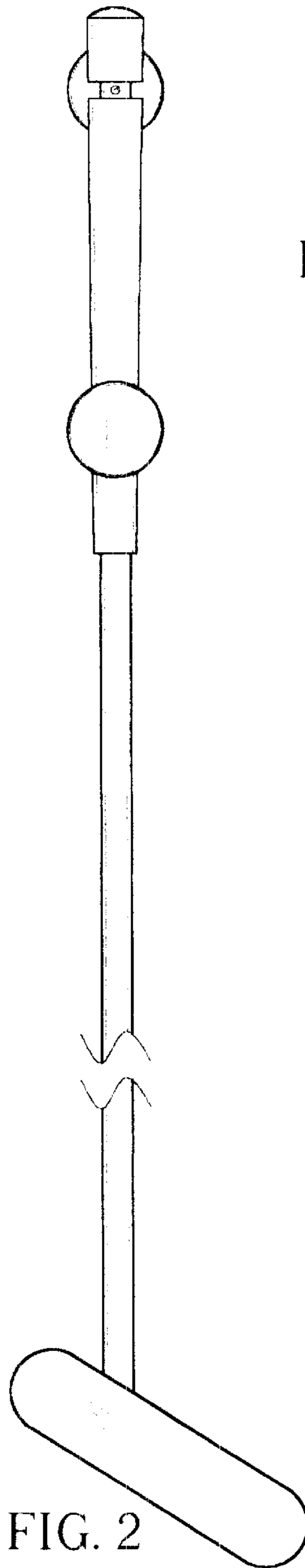
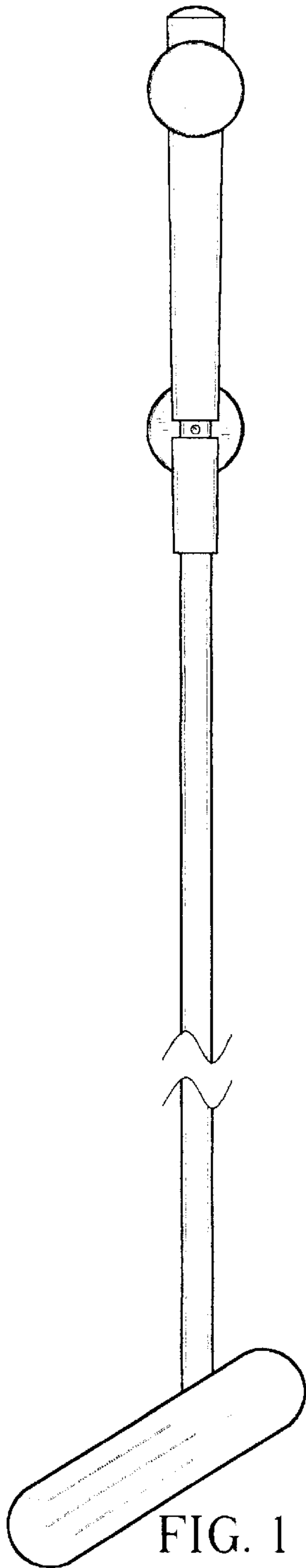

FIG. 3

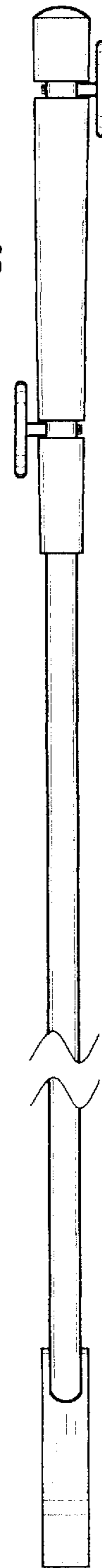

FIG. 4

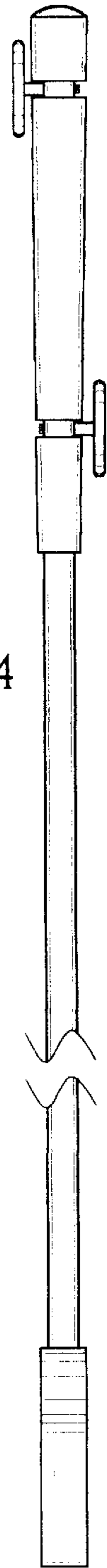

FIG. 5

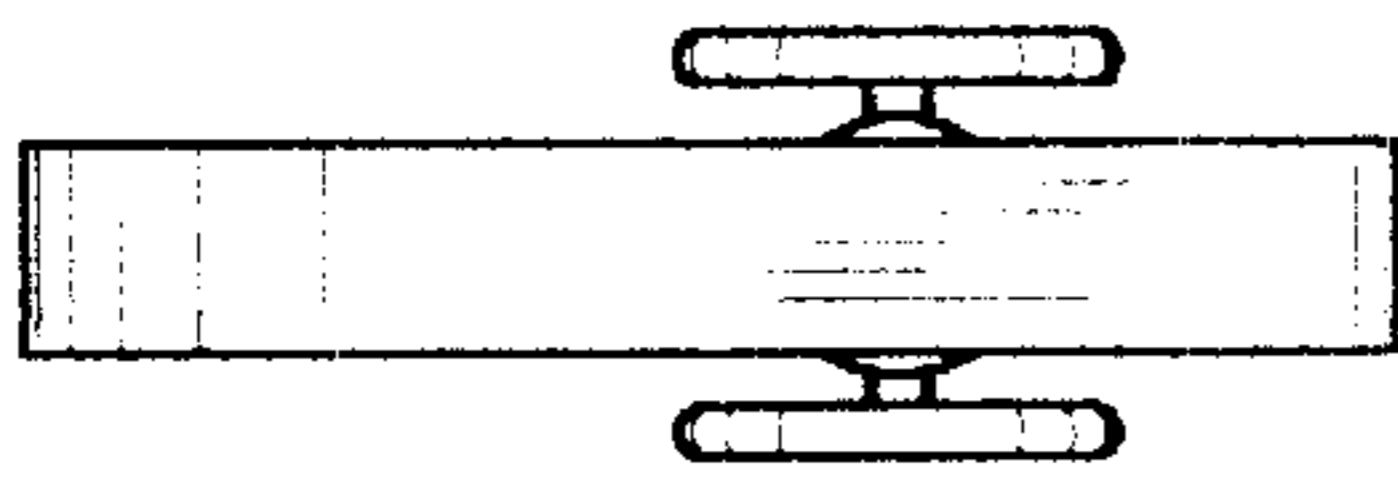
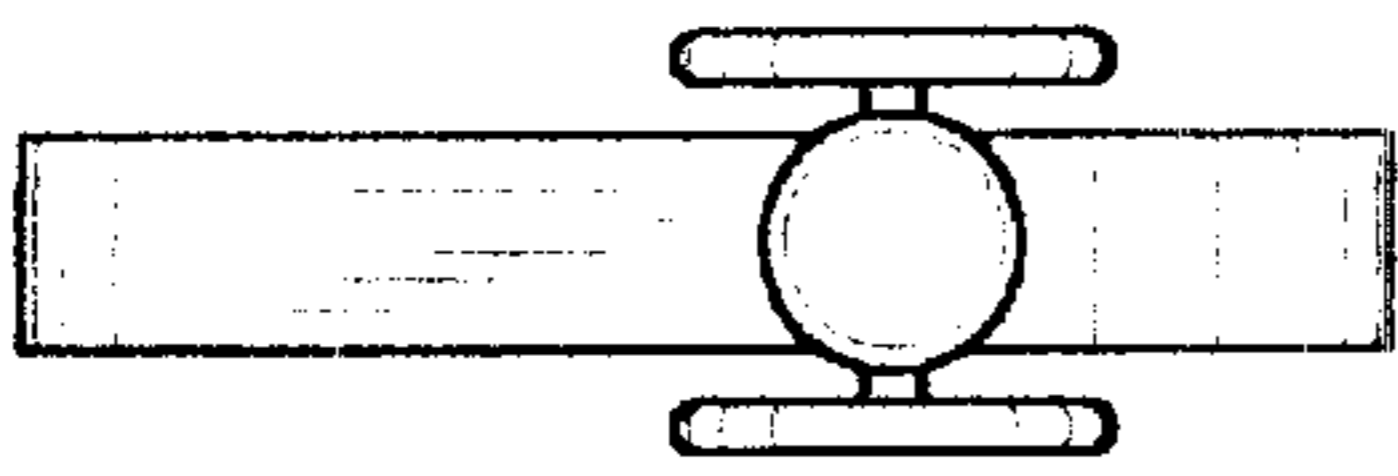

FIG. 6

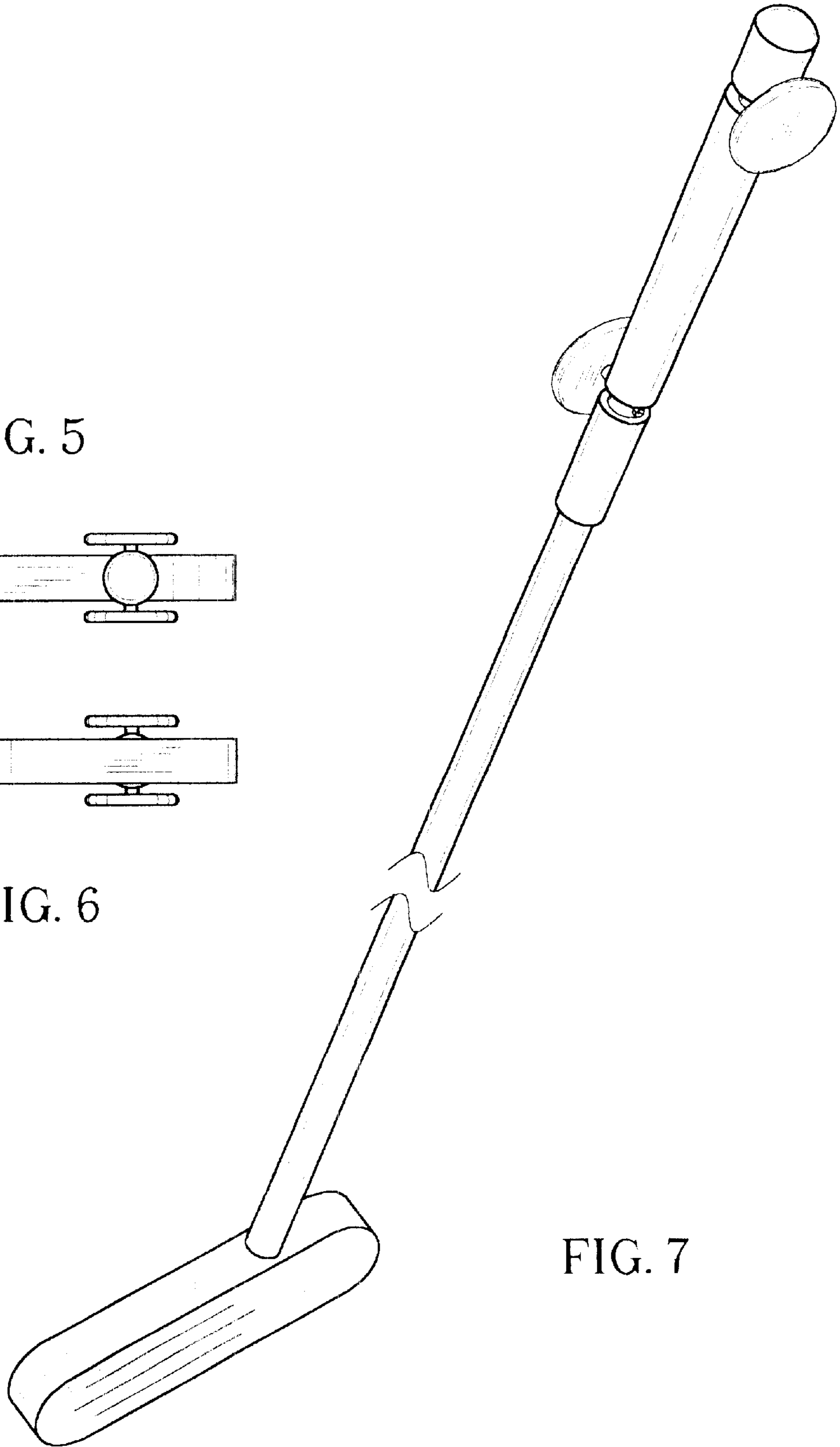

FIG. 7