



US00D468318S

(12) **United States Design Patent**
Chien et al.

(10) **Patent No.:** **US D468,318 S**

(45) **Date of Patent:** **** Jan. 7, 2003**

(54) **COMPUTER FRONT BEZEL**

D451,514 S * 12/2001 Jean et al. D14/441

(75) Inventors: **Chieh-Nan Chien**, Tu-Chen (TW);
Yin-Sheng Yeh, Tu-Chen (TW);
Fu-Ming Chen, Tu-Chen (TW)

* cited by examiner

Primary Examiner—Freda Nunn
(74) *Attorney, Agent, or Firm*—Wei Te Chung

(73) Assignee: **Hon Hai Precision Ind. Co., Ltd.**,
Taipei Hsien (TW)

(57) **CLAIM**

(**) Term: **14 Years**

The ornamental design for a computer front bezel, as shown and described.

(21) Appl. No.: **29/155,843**

DESCRIPTION

(22) Filed: **Feb. 15, 2002**

FIG. 1 is a perspective view of a computer front bezel of our new design;

(51) **LOC (7) Cl.** **14-02**

FIG. 2 is a front elevational view thereof;

(52) **U.S. Cl.** **D14/445**

FIG. 3 is a rear elevational view thereof;

(58) **Field of Search** D14/441-446;
D13/162, 184, 199; 312/223.2; 361/680-686,
690-696

FIG. 4 is a left side elevational view thereof;

FIG. 5 is a right side elevational view thereof;

FIG. 6 is a top plan view thereof;

FIG. 7 is a bottom plan view thereof; and,

FIG. 8 is a view similar to FIG. 1 with the computer front bezel being mounted to a computer case which is shown in broken lines for illustrative purposes only and forms no part of the claimed design.

(56) **References Cited**

U.S. PATENT DOCUMENTS

- D409,176 S * 5/1999 Lai D14/445
- D423,487 S * 4/2000 Lai D14/445
- D427,195 S * 6/2000 Jean et al. D14/441

1 Claim, 6 Drawing Sheets

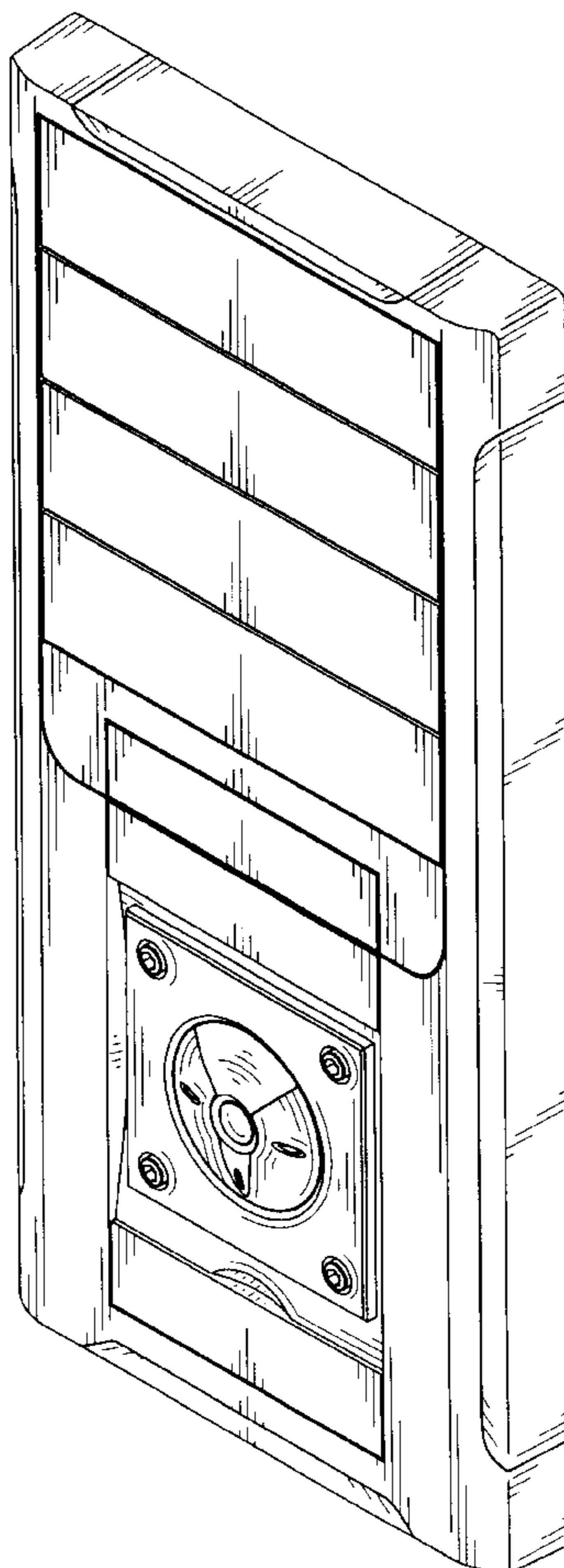

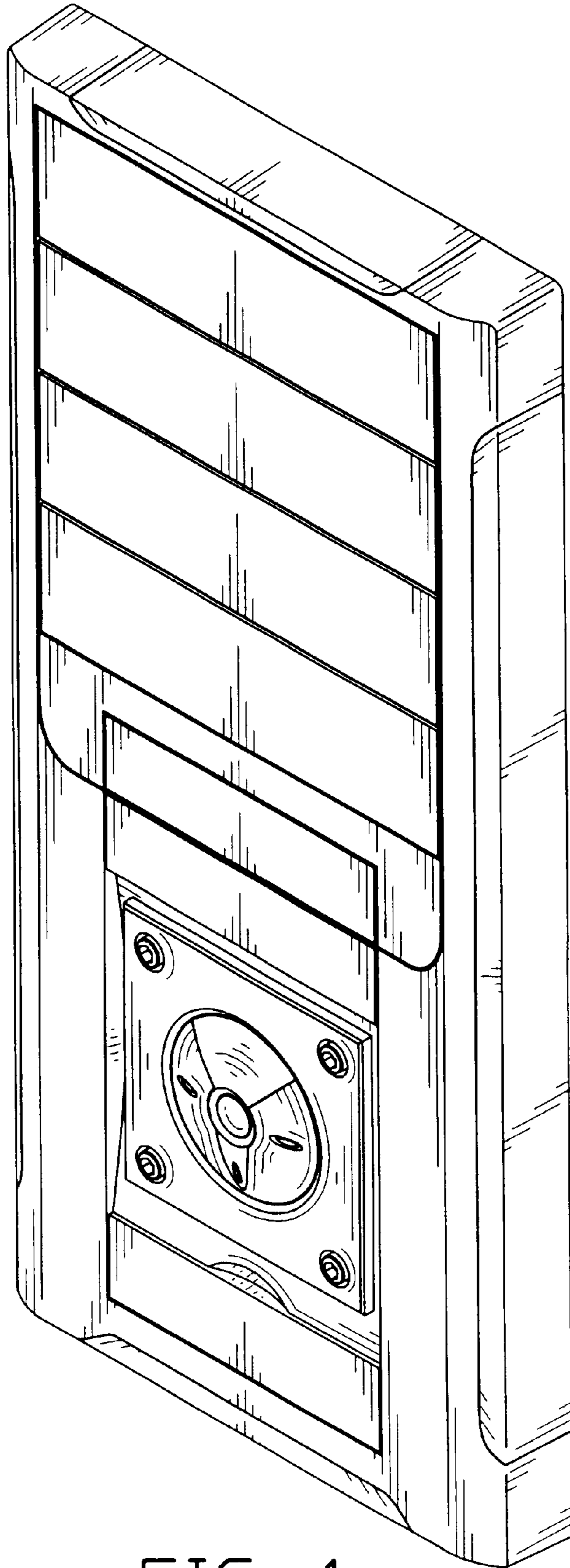

FIG. 1

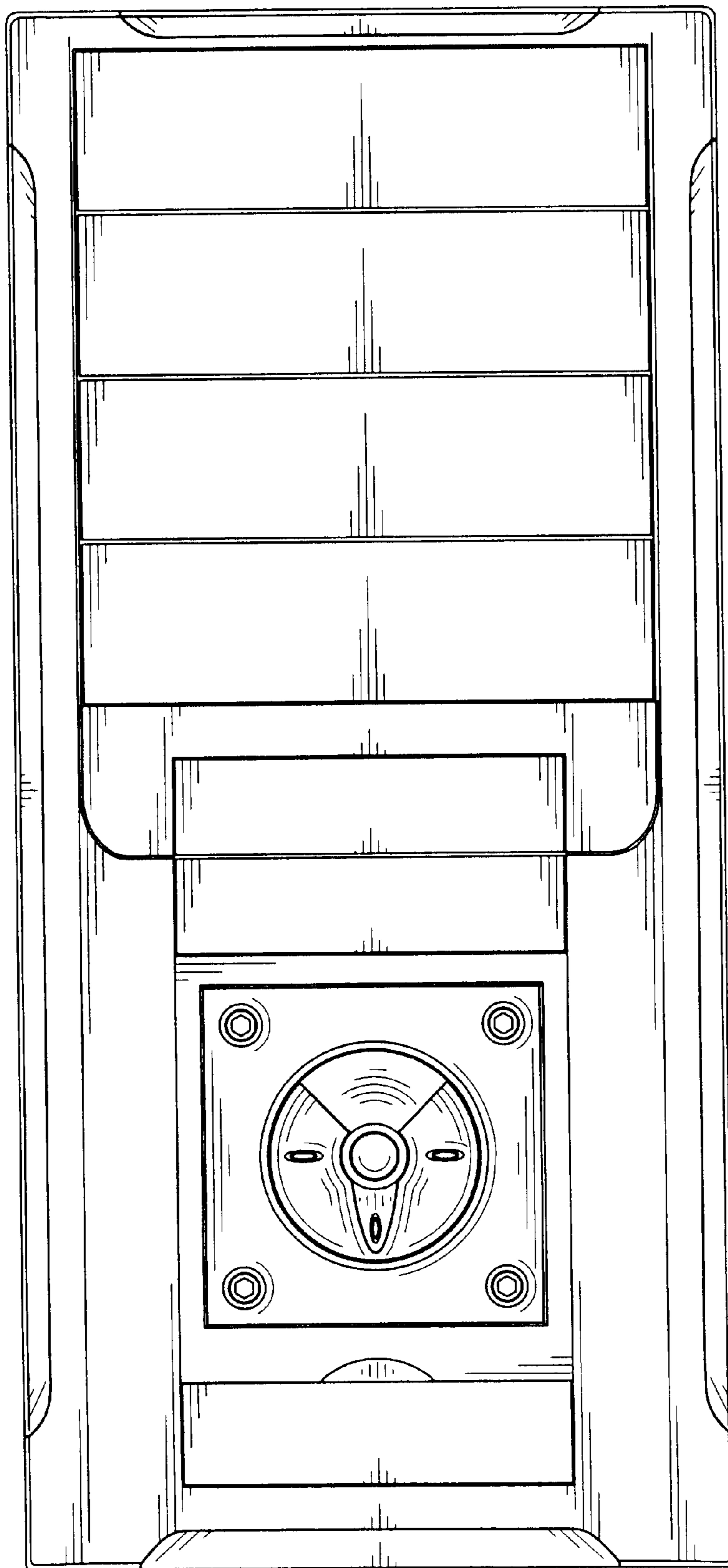

FIG. 2

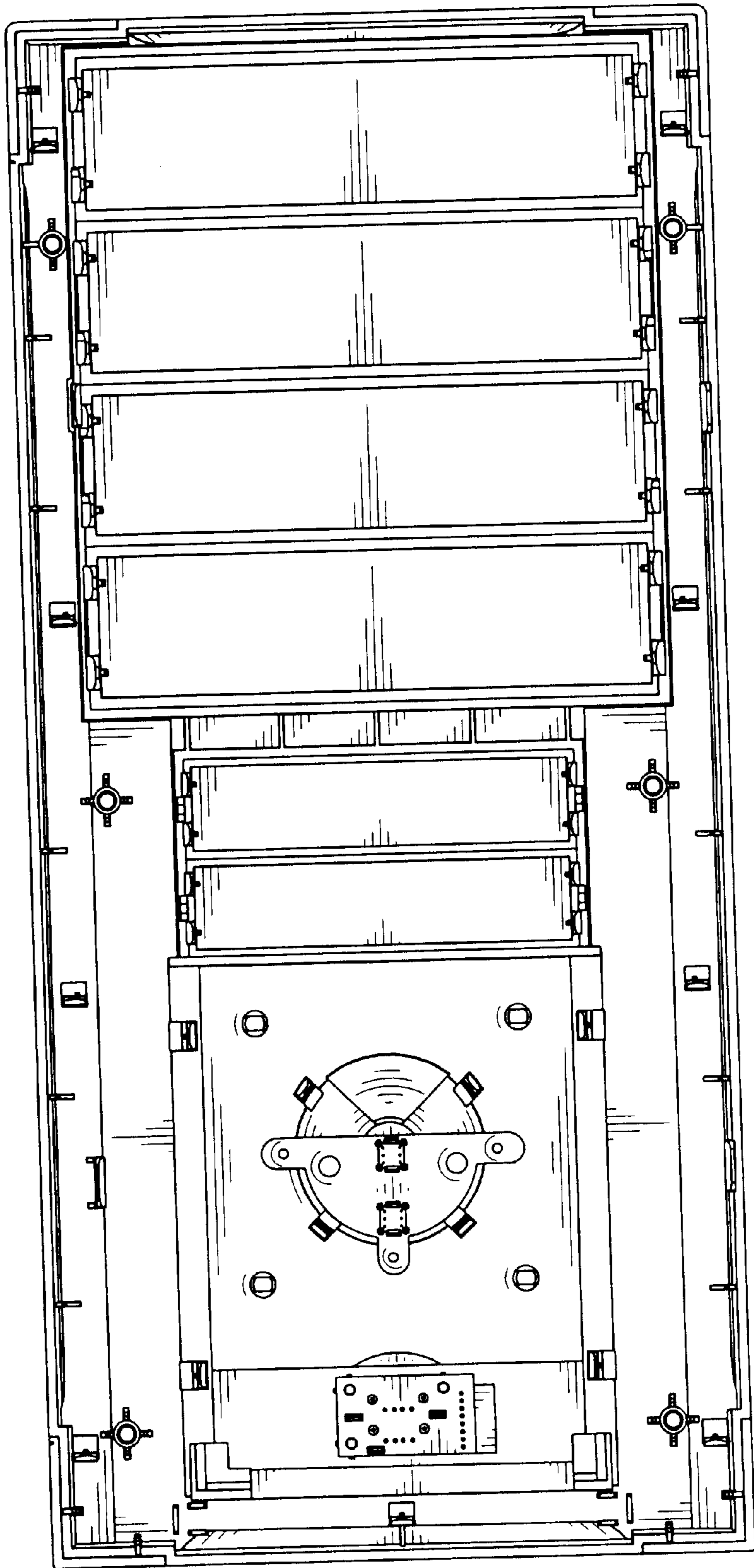

FIG. 3

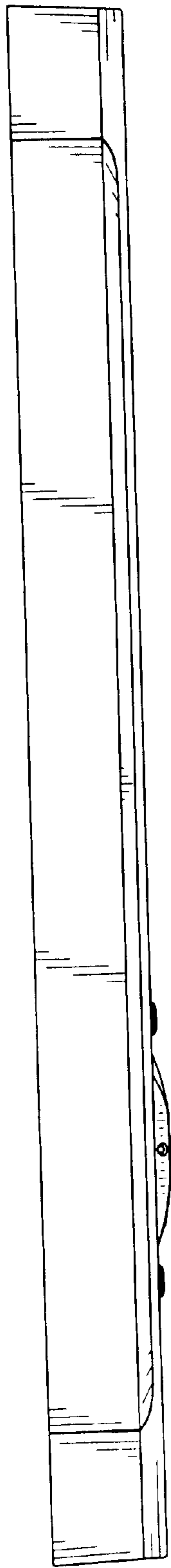

FIG. 4

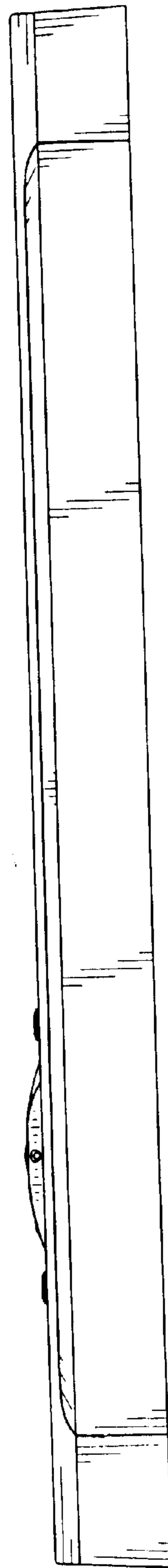

FIG. 5

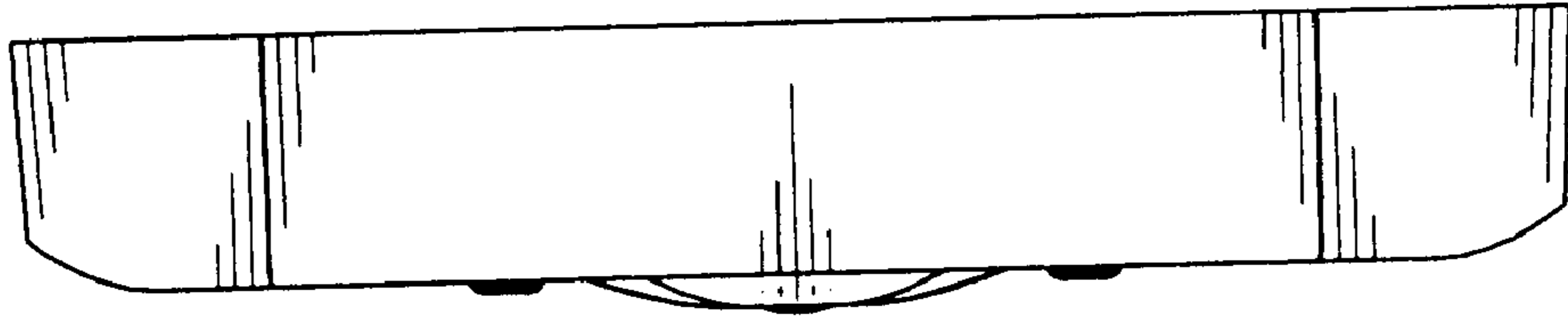

FIG. 6

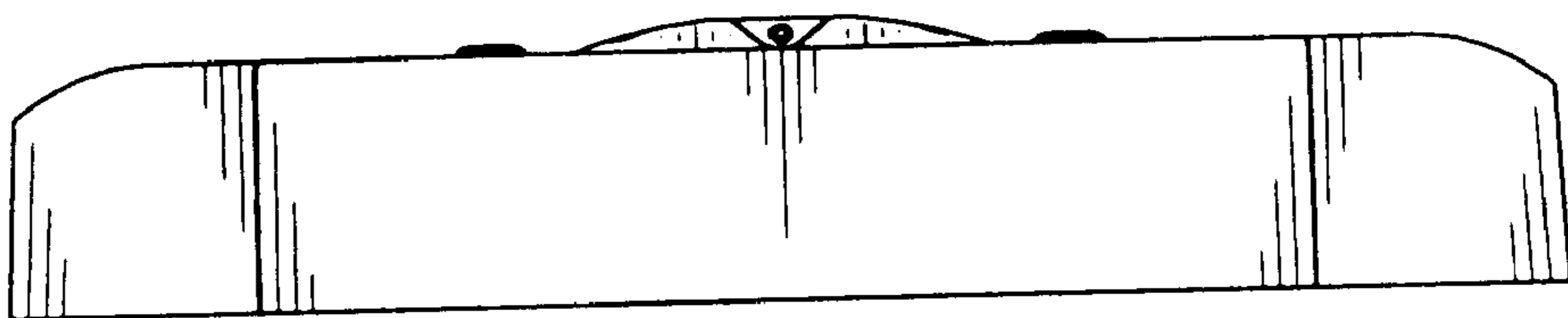

FIG. 7

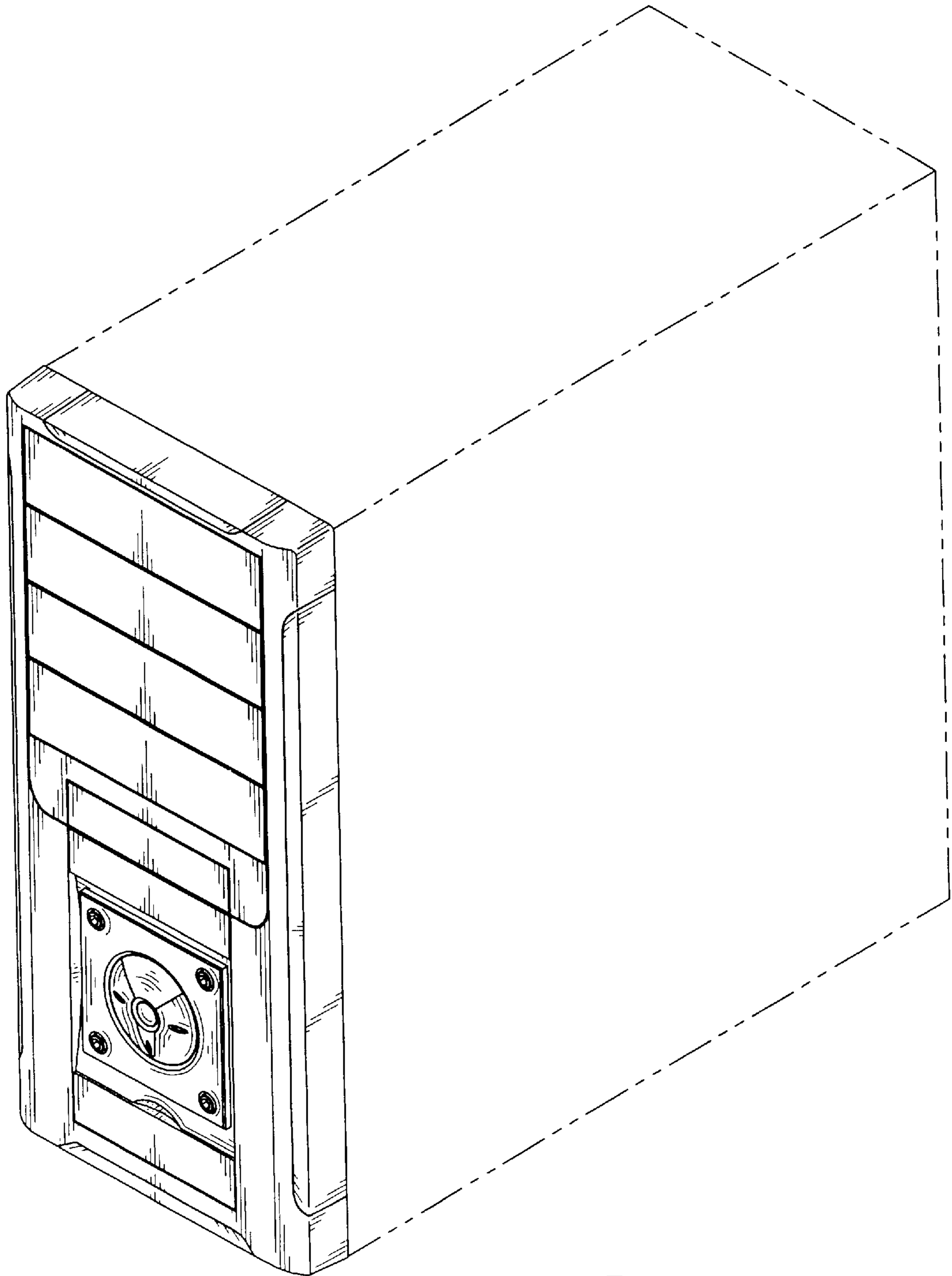

FIG. 8