



US00D468285S

(12) **United States Design Patent**
Mizokawa

(10) **Patent No.:** **US D468,285 S**
(45) **Date of Patent:** **** Jan. 7, 2003**

(54) **DIGITAL AUDIO DISC PLAYER FOR VEHICLE**

D430,552 S * 9/2000 Nose D14/157

FOREIGN PATENT DOCUMENTS

(75) Inventor: **Hiroyuki Mizokawa**, Kanagawa (JP)

JP 1070304 5/2000

(73) Assignee: **Matsushita Electric Industrial Co., Ltd.**, Osaka (JP)

* cited by examiner

(**) Term: **14 Years**

Primary Examiner—Nanda Bondade
(74) *Attorney, Agent, or Firm*—Christensen O'Connor Johnson Kindness PLLC

(21) Appl. No.: **29/150,887**

(57) **CLAIM**

(22) Filed: **Oct. 19, 2001**

The ornamental design for a digital audio disc player for vehicle, as shown and described.

(30) **Foreign Application Priority Data**

DESCRIPTION

Apr. 19, 2001 (JP) 2001-011359

(51) **LOC (7) Cl.** **14-03**

(52) **U.S. Cl.** **D14/157**

(58) **Field of Search** D14/135-136,
D14/156-157, 167-168, 188, 193-198,
257-258; 369/75.1, 75.2, 77.1, 77.2; 455/344,
347, 350-351

FIG. 1 is a perspective view of the top, front and right side of a digital audio disc player for vehicle showing my new design;

FIG. 2 is a front view thereof;

FIG. 3 is a rear view thereof;

FIG. 4 is a right side view thereof;

FIG. 5 is a left side view thereof;

FIG. 6 is a top plan view thereof;

FIG. 7 is a bottom view thereof; and,

FIG. 8 is a perspective view thereof with the lid in open condition.

(56) **References Cited**

U.S. PATENT DOCUMENTS

5,953,302 A * 9/1999 Kobayashi 369/75.1

D415,491 S * 10/1999 Yano et al. D14/168

D421,007 S * 2/2000 Nagai D14/156

1 Claim, 6 Drawing Sheets

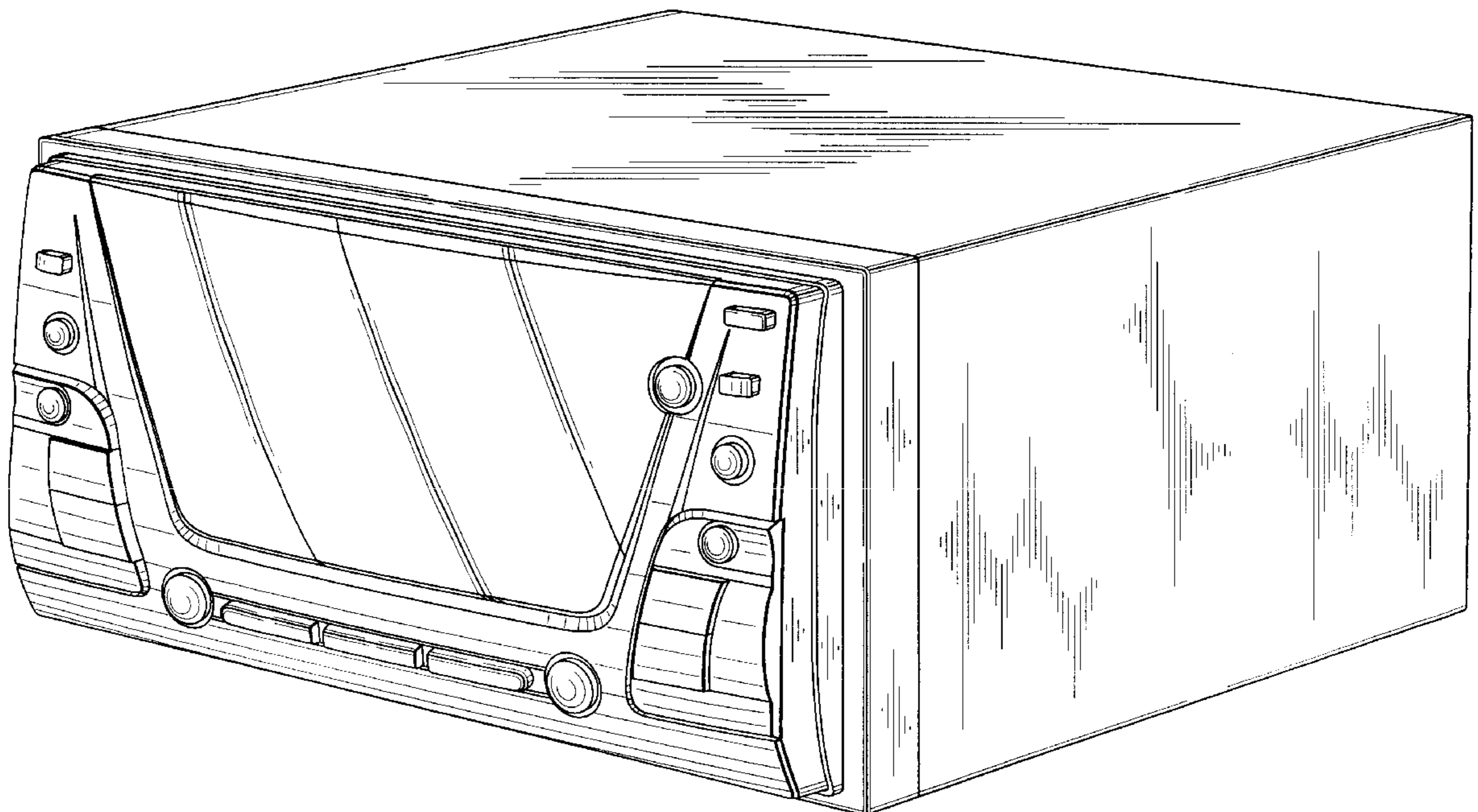

FIG. 1

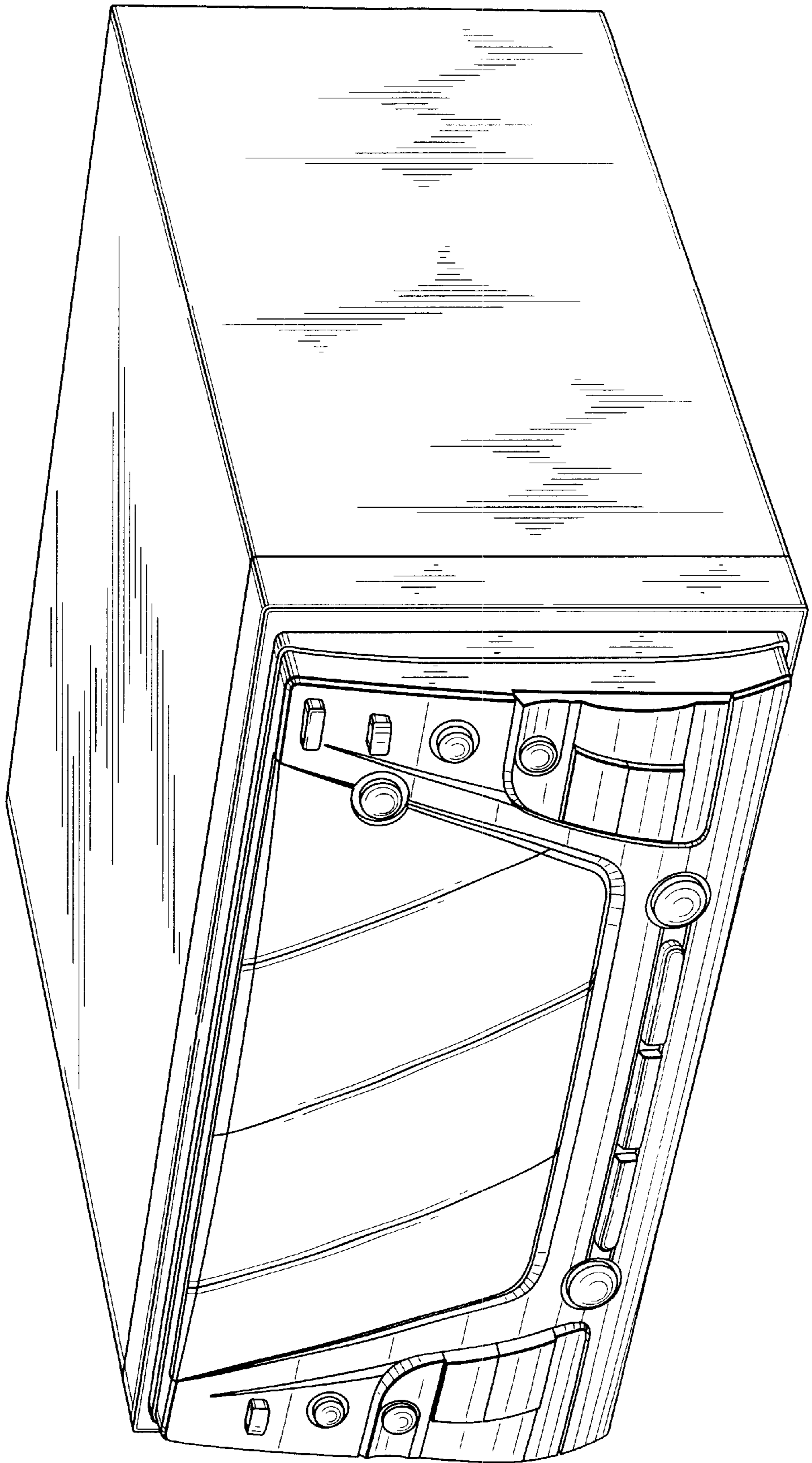

FIG. 2

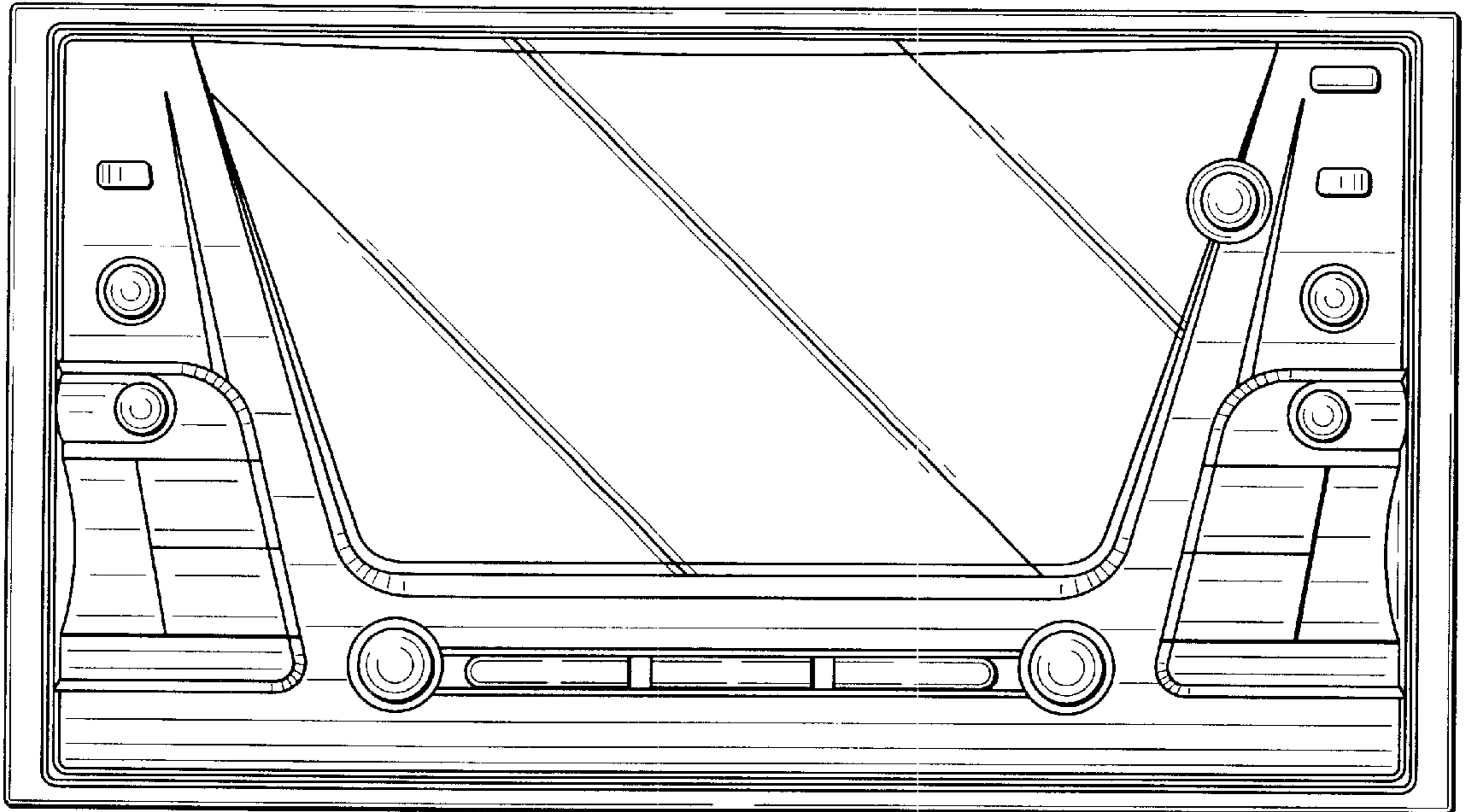

FIG. 3

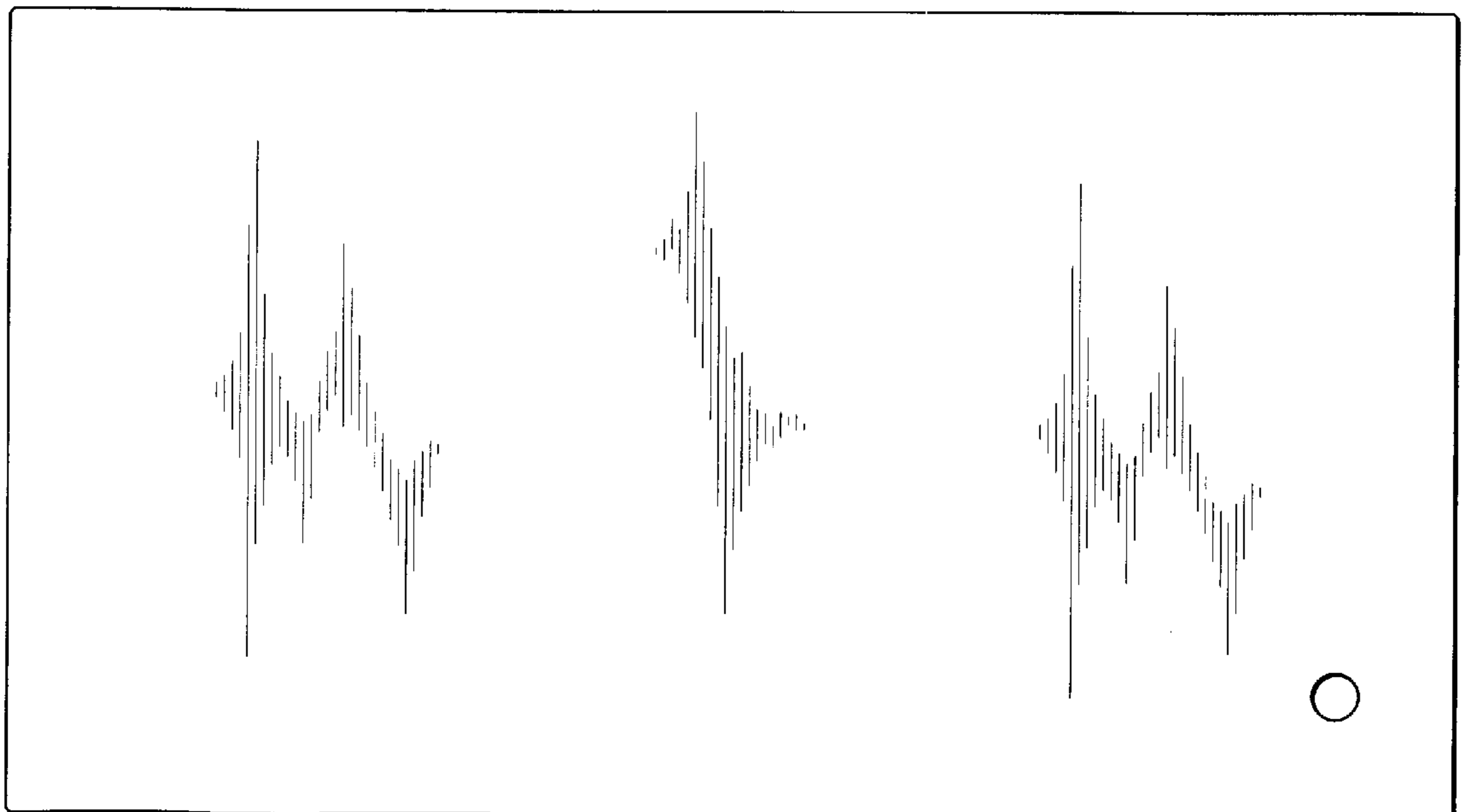

FIG. 4

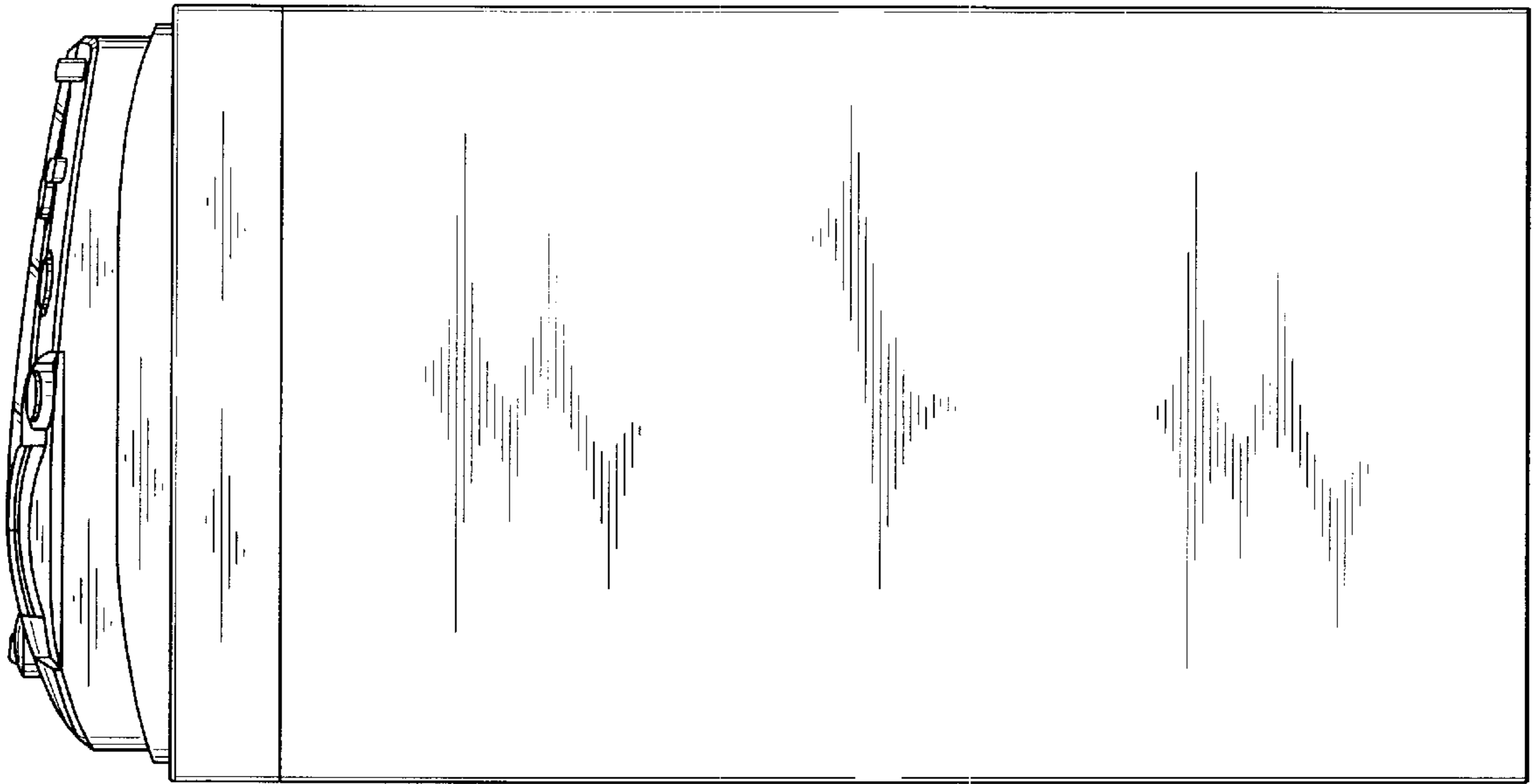

FIG. 5

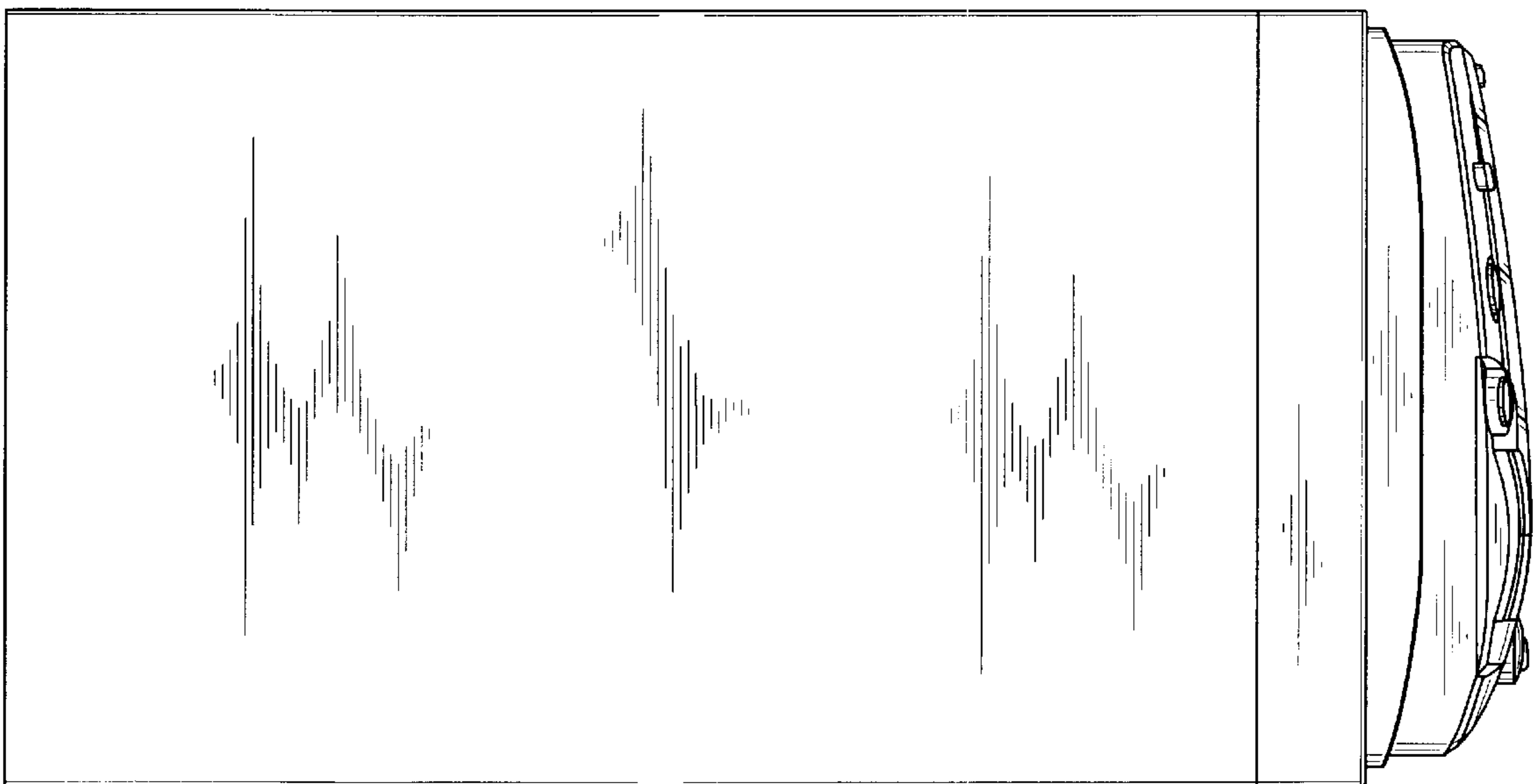

FIG. 6

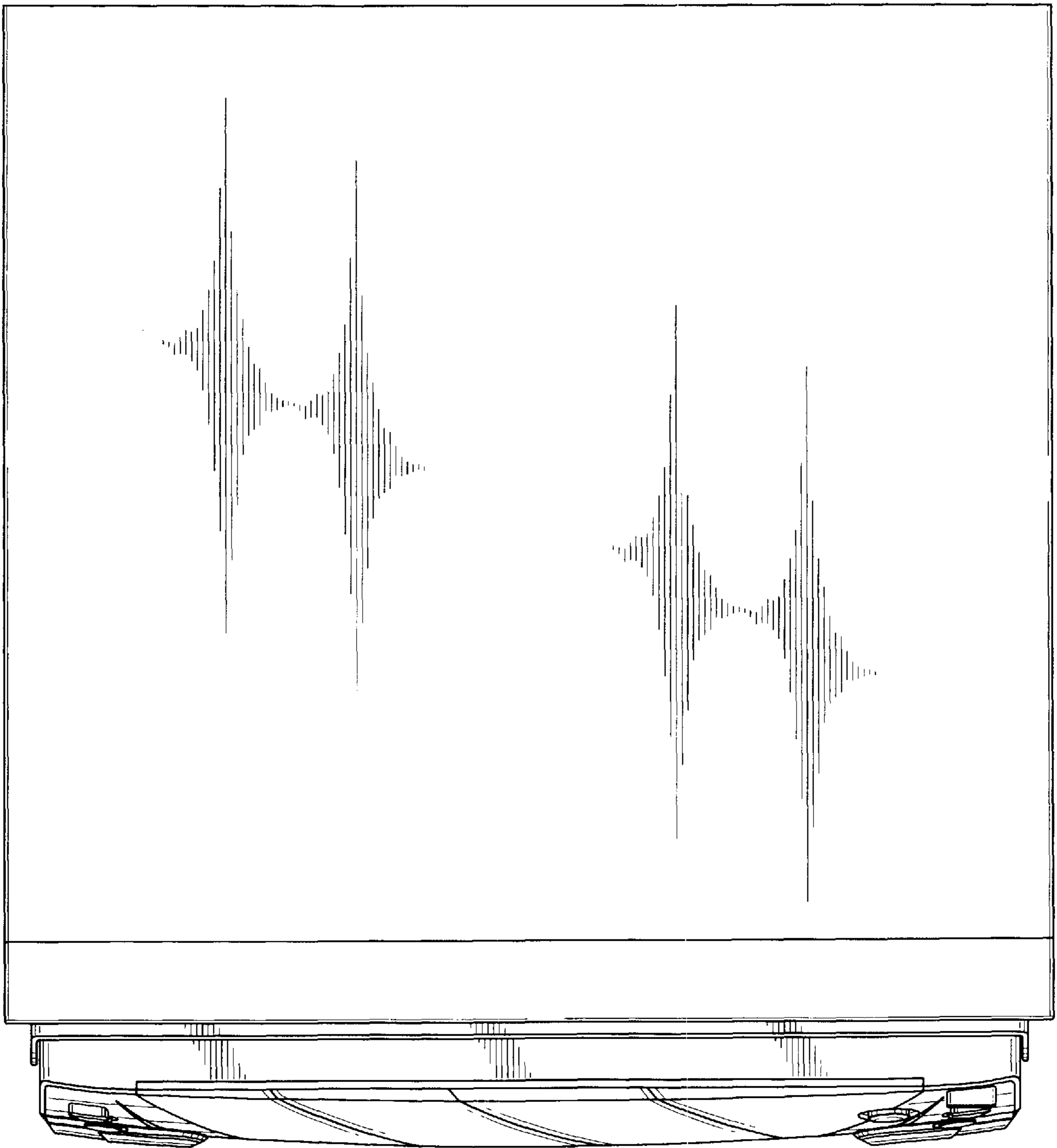

FIG. 7

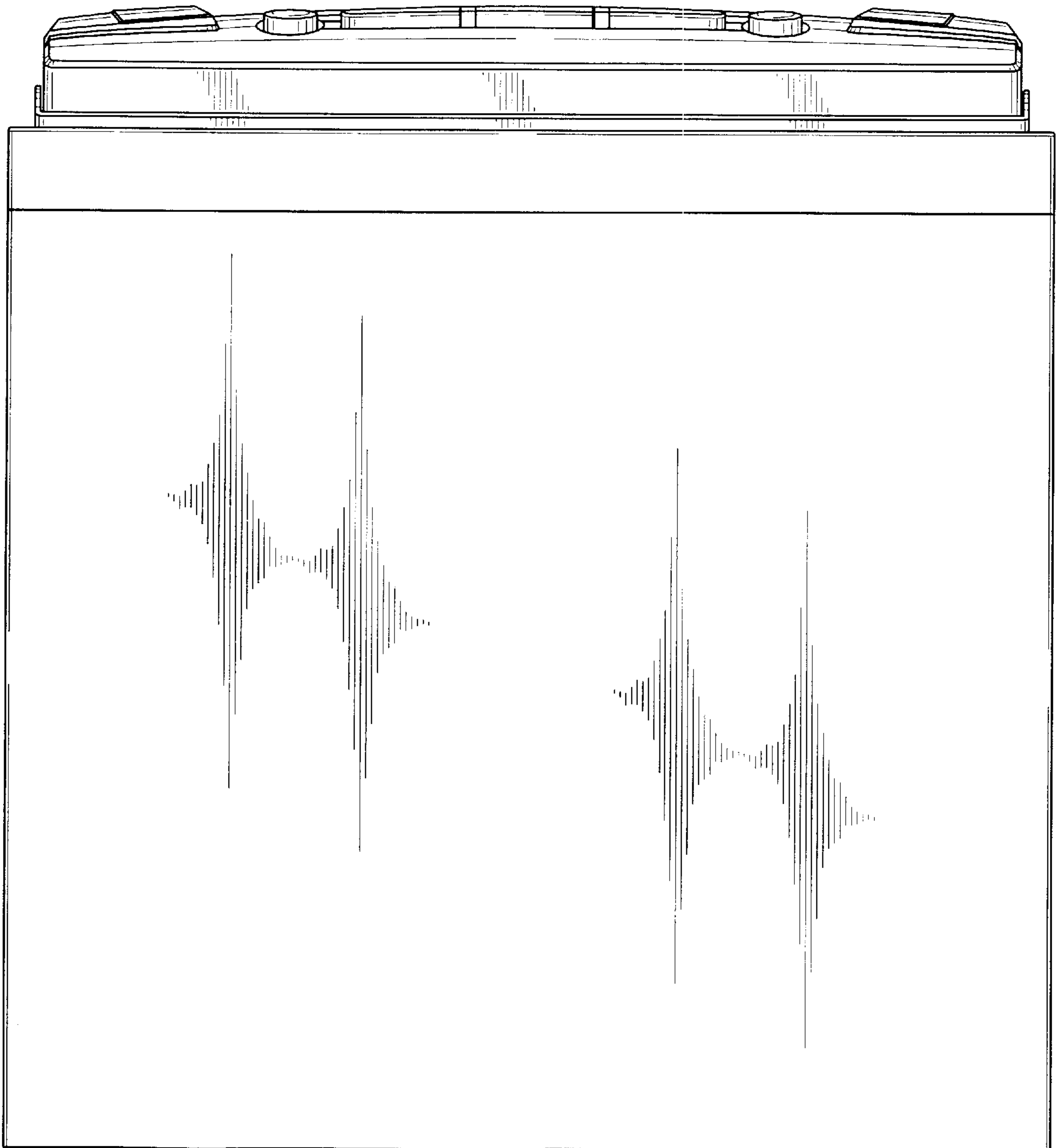

FIG. 8

