



US00D468252S

(12) **United States Design Patent**
Morris

(10) **Patent No.:** **US D468,252 S**

(45) **Date of Patent:** **** Jan. 7, 2003**

(54) **SLEEPER SHOCK ABSORBER COVER**

(76) Inventor: **Mark Morris**, P.O. Box 706,
Tunkhannock, PA (US) 18657

(**) Term: **14 Years**

(21) Appl. No.: **29/146,798**

(22) Filed: **Aug. 17, 2001**

(51) **LOC (7) Cl.** **12-06**

(52) **U.S. Cl.** **D12/223; D8/349**

(58) **Field of Search** **D12/223, 106,**
D12/159, 196, 126; D8/349, 356, 359;
280/96.1; 248/200, 300; 296/37.1, 57.1,
37.3

(56) **References Cited**

U.S. PATENT DOCUMENTS

D341,343 S	*	11/1993	Netz	D12/126
D424,480 S	*	5/2000	Ricci	D12/126
D437,282 S	*	2/2001	Joll	D12/223
D444,104 S	*	6/2001	Baker	D12/126

* cited by examiner

Primary Examiner—Melody N. Brown

(74) *Attorney, Agent, or Firm*—Ropes & Gray; Gregory J. Glover; Sanjay Sitlani

(57) **CLAIM**

The ornamental design for a portion of a sleeper shock absorber cover, as shown and described.

DESCRIPTION

FIG. 1 is a perspective view of a sleeper shock absorber showing my new design;

FIG. 2 is a left side view thereof;

FIG. 3 is a front view thereof;

FIG. 4 is a rear view thereof;

FIG. 5 is a top view thereof;

FIG. 6 is a bottom view thereof; and,

FIG. 7 is a perspective view thereof, the broken lines are shown for illustrative purposes only and form no part of the claimed design.

1 Claim, 3 Drawing Sheets

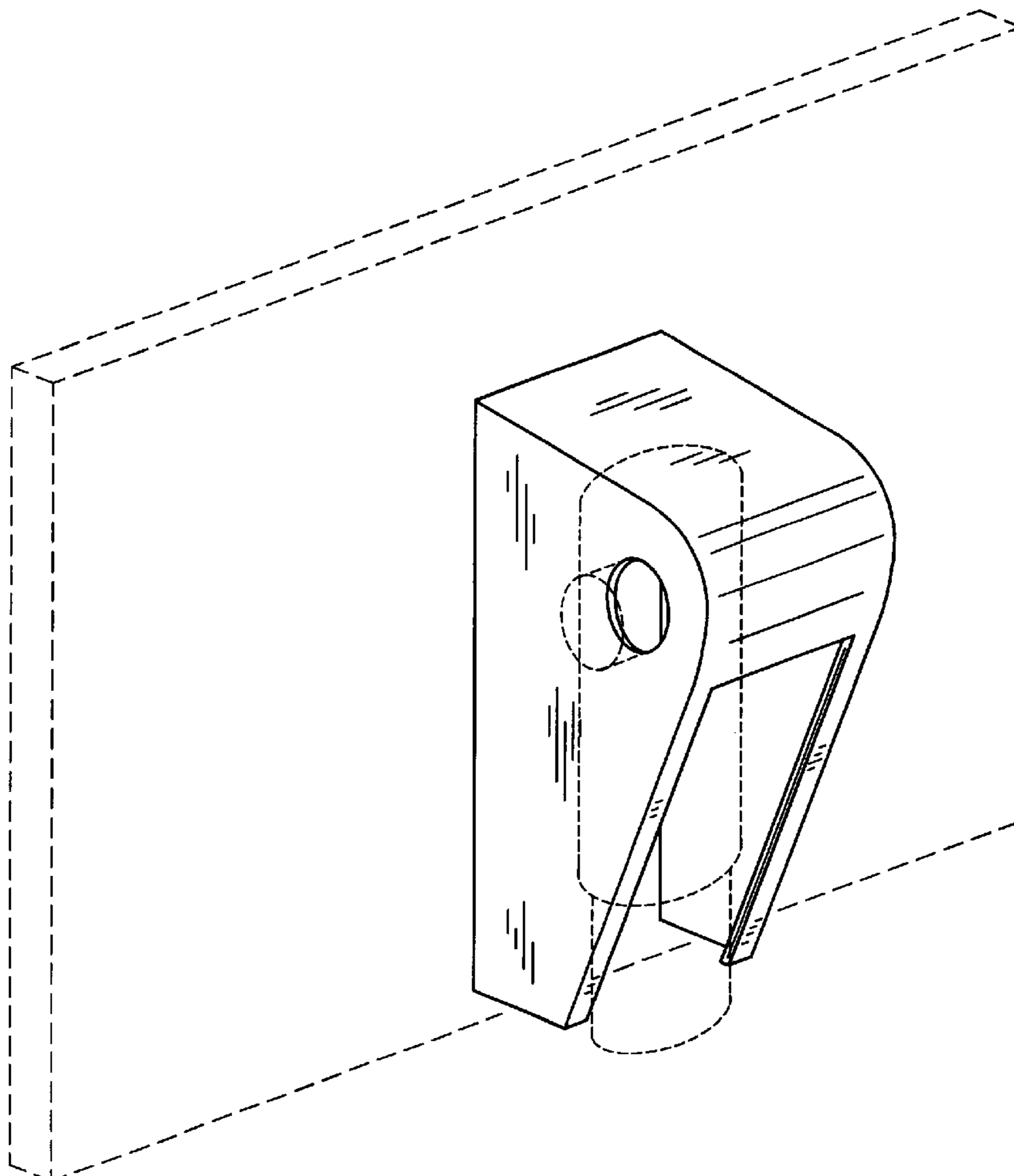

FIG. 1

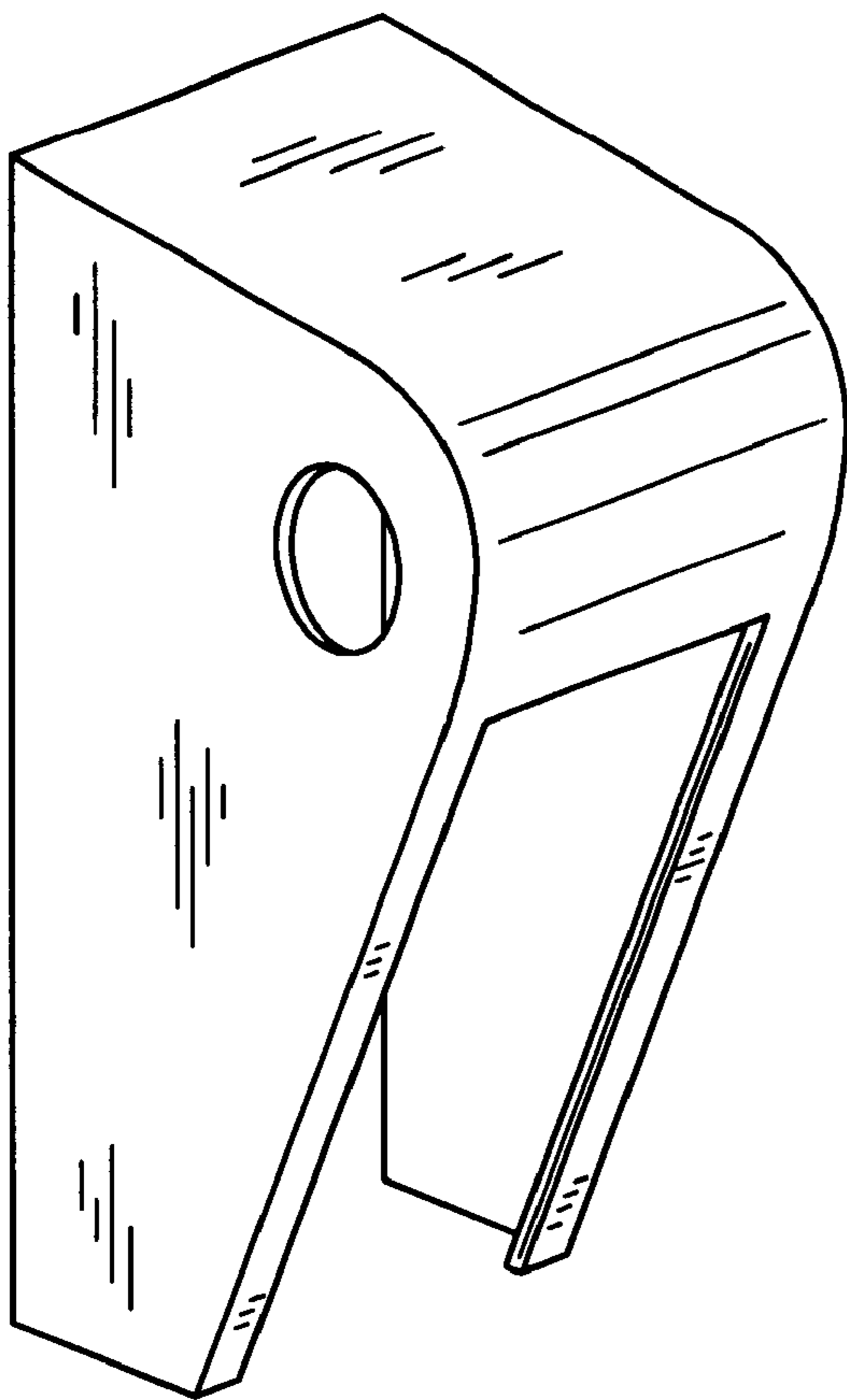

FIG. 2

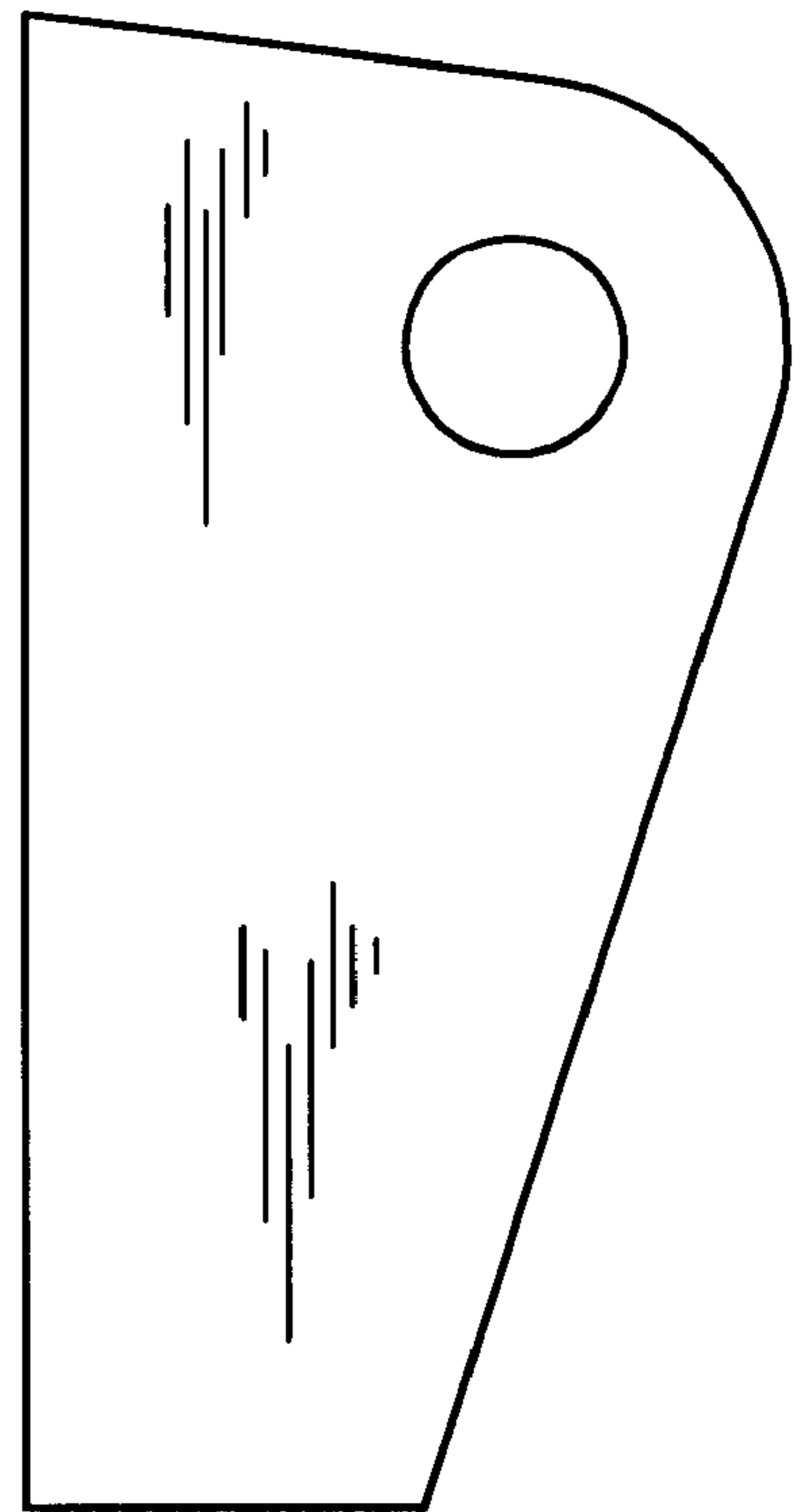

FIG. 3

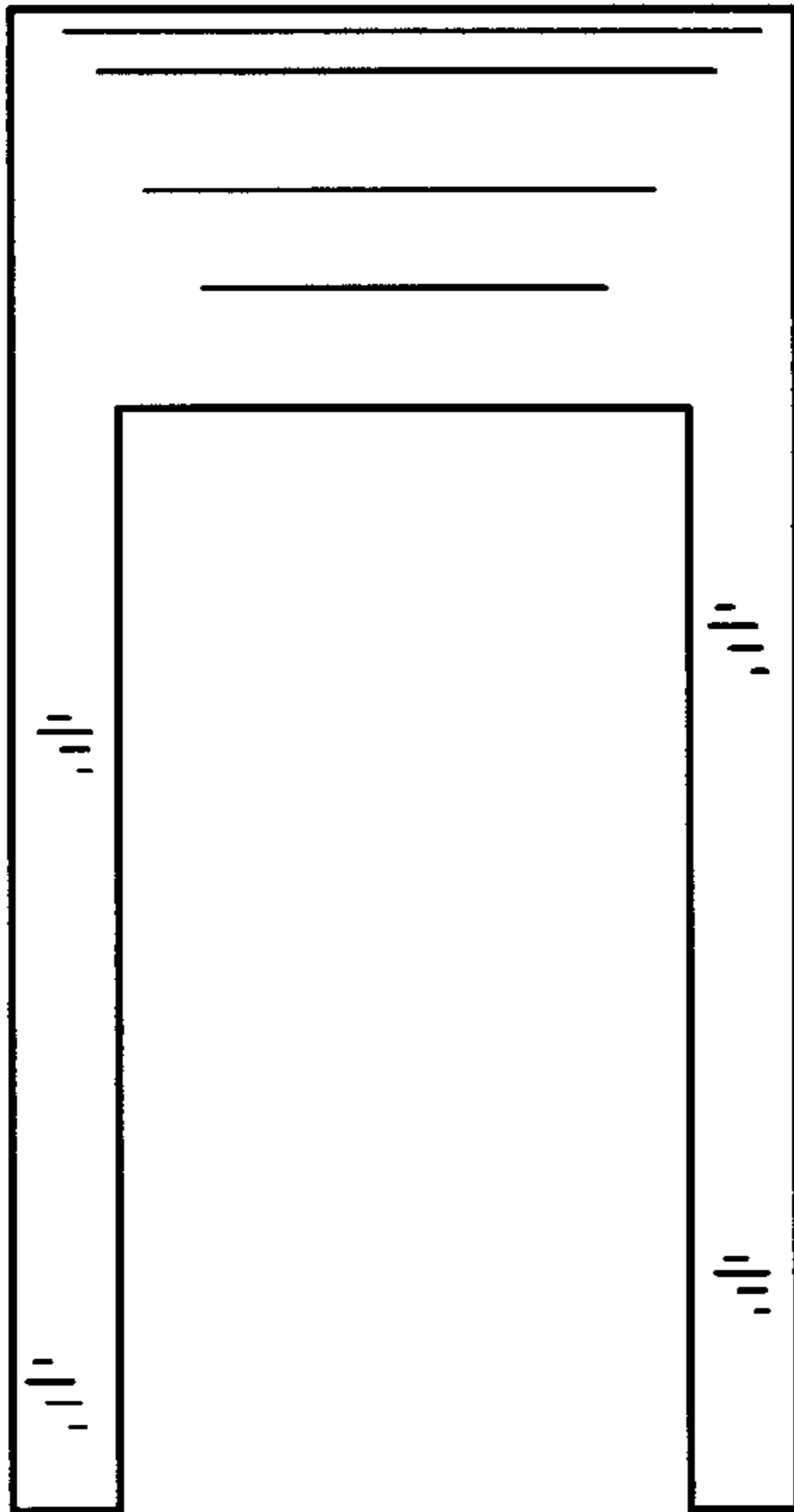

FIG. 4

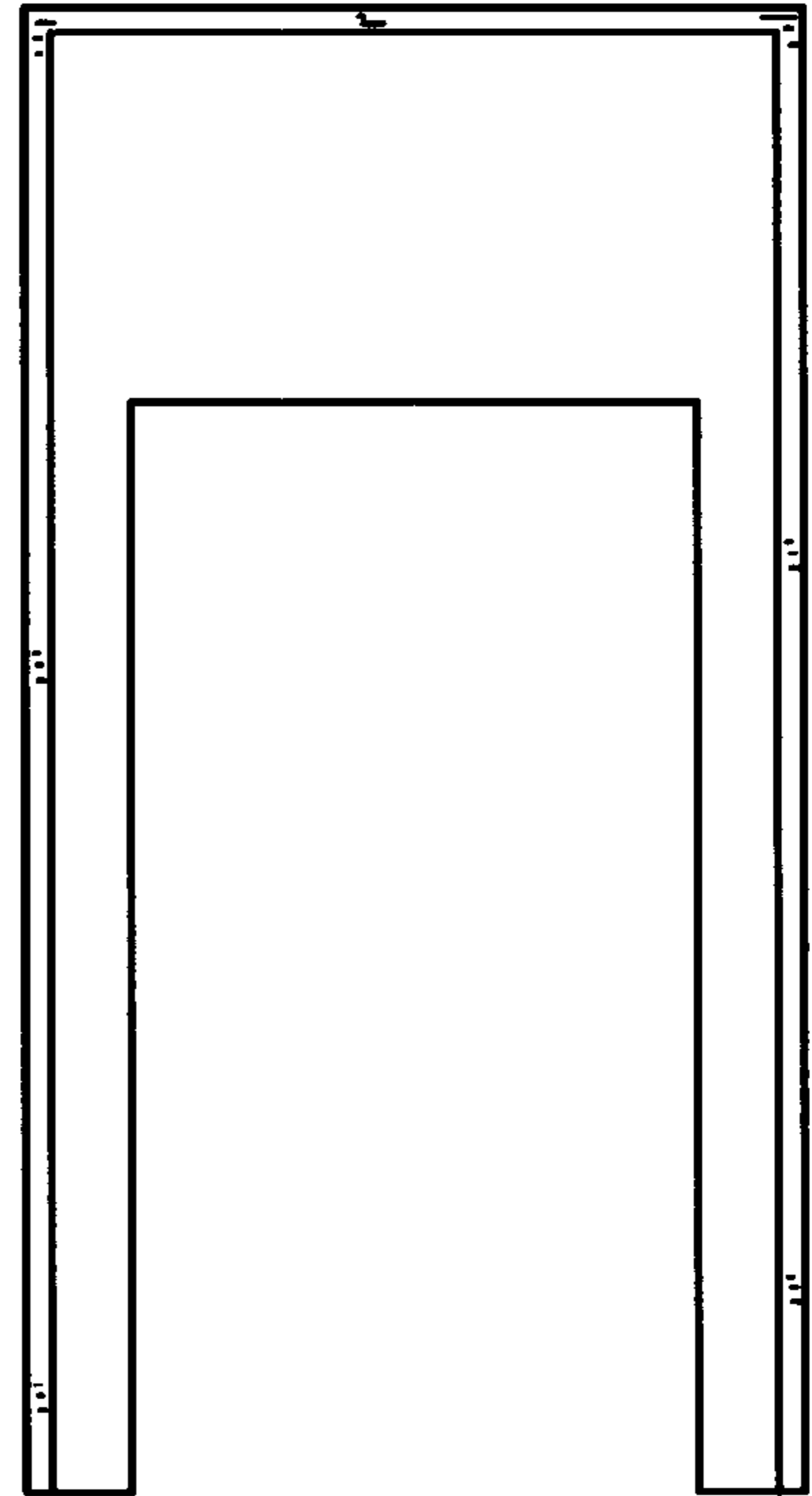

FIG. 5

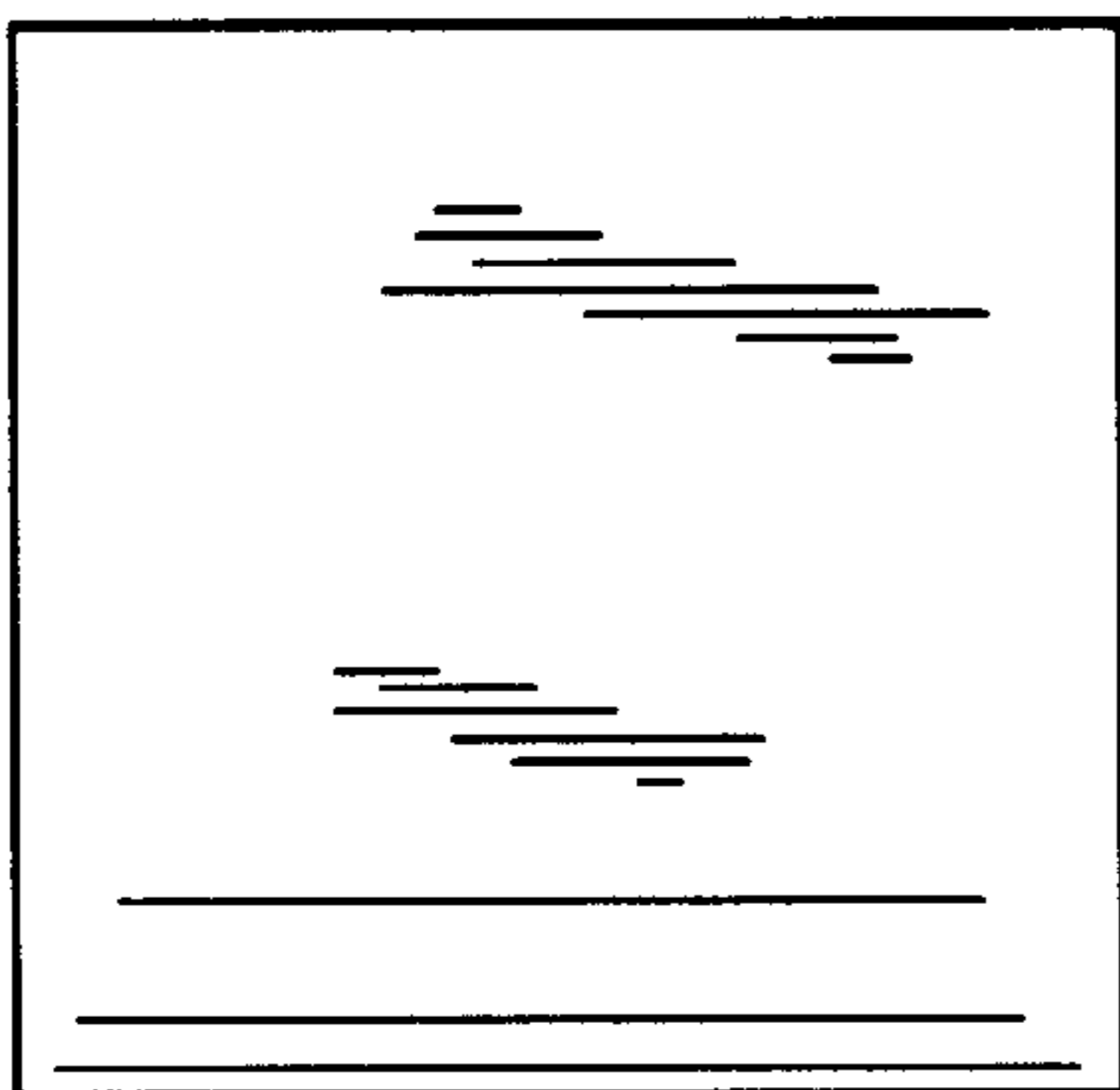

FIG. 6

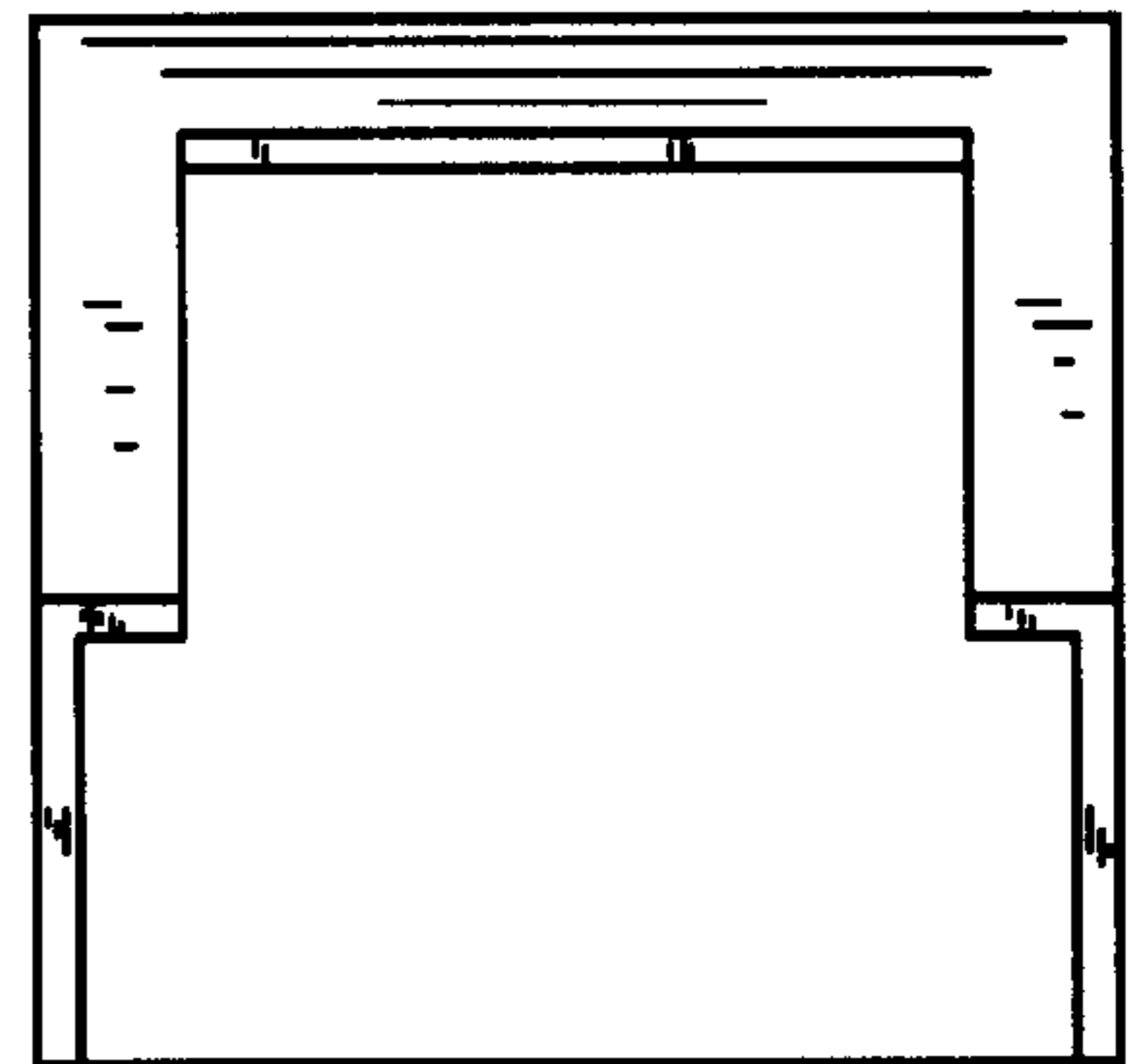

FIG. 7

