



US00D468091S

(12) **United States Design Patent**  
**Tipton**

(10) **Patent No.:** **US D468,091 S**

(45) **Date of Patent:** **\*\* Jan. 7, 2003**

(54) **KEY CHAIN**

D401,054 S \* 11/1998 Hartmann et al. .... D3/212  
D443,556 S \* 6/2001 Sinha et al. .... D11/96

(76) **Inventor:** **Edward E. Tipton**, P.O. Box 639,  
Sneads, FL (US) 32460

\* cited by examiner

(\*\*) **Term:** **14 Years**

*Primary Examiner*—Ralf Seifert  
(74) *Attorney, Agent, or Firm*—Peter Loffler

(21) **Appl. No.:** **29/141,132**

(57) **CLAIM**

(22) **Filed:** **May 1, 2001**

The ornamental design for a key chain, as shown and described.

(51) **LOC (7) Cl.** ..... **03-01**

(52) **U.S. Cl.** ..... **D3/212**

(58) **Field of Search** ..... D11/1, 2, 43-46,  
D11/48-50, 54, 57-58, 61, 65-66, 79-83,  
95-102, 107, 110, 116; D3/207-212; 63/13,  
18-20, 23; 24/3.6

**DESCRIPTION**

FIG. 1 is a perspective view of the key chain;  
FIG. 2 is a top plan view thereof;  
FIG. 3 is a right side elevation view thereof.  
FIG. 4 is a left side view thereof;  
FIG. 5 is a bottom plan view thereof;  
FIG. 6 is a front elevation view thereof; and,  
FIG. 7 is a rear elevation view thereof.  
It being understood that the broken lines are for illustrative purposes only.

(56) **References Cited**

**U.S. PATENT DOCUMENTS**

660,025 A \* 10/1900 Pemberton ..... 63/18  
D281,959 S \* 12/1985 Balbuena ..... D11/81  
D324,189 S \* 2/1992 Makoshi ..... D11/80

**1 Claim, 3 Drawing Sheets**

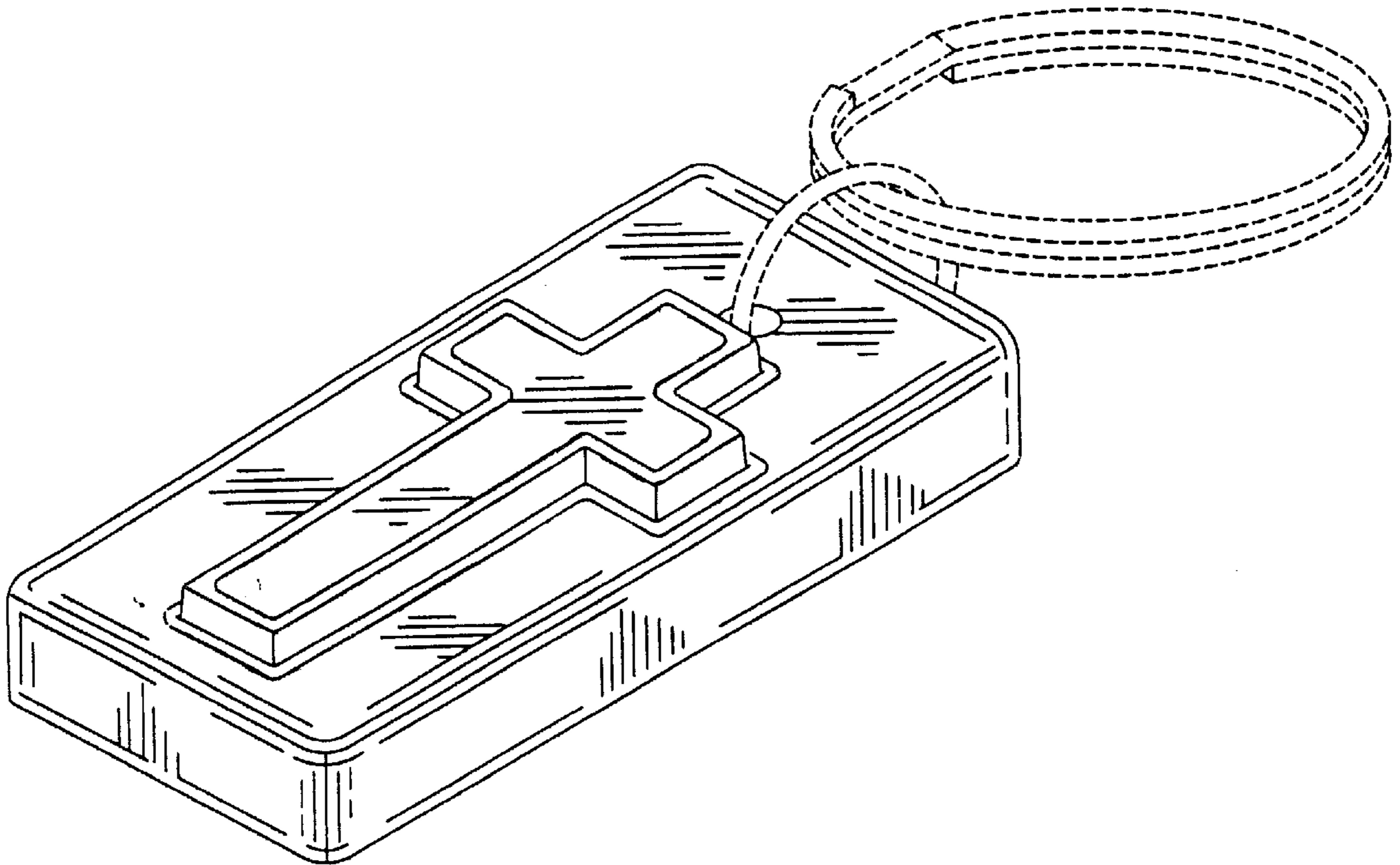

FIG. 1.

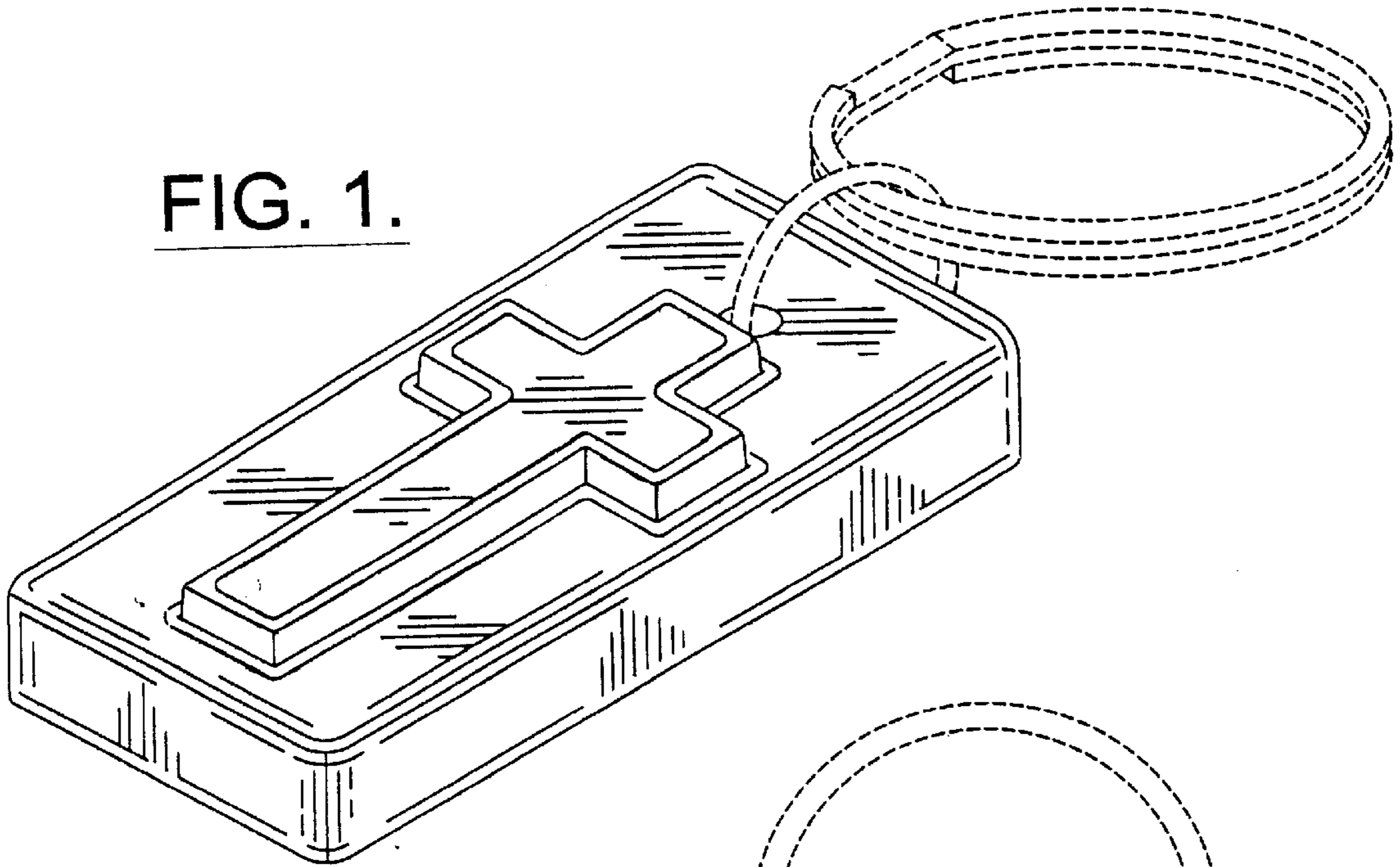
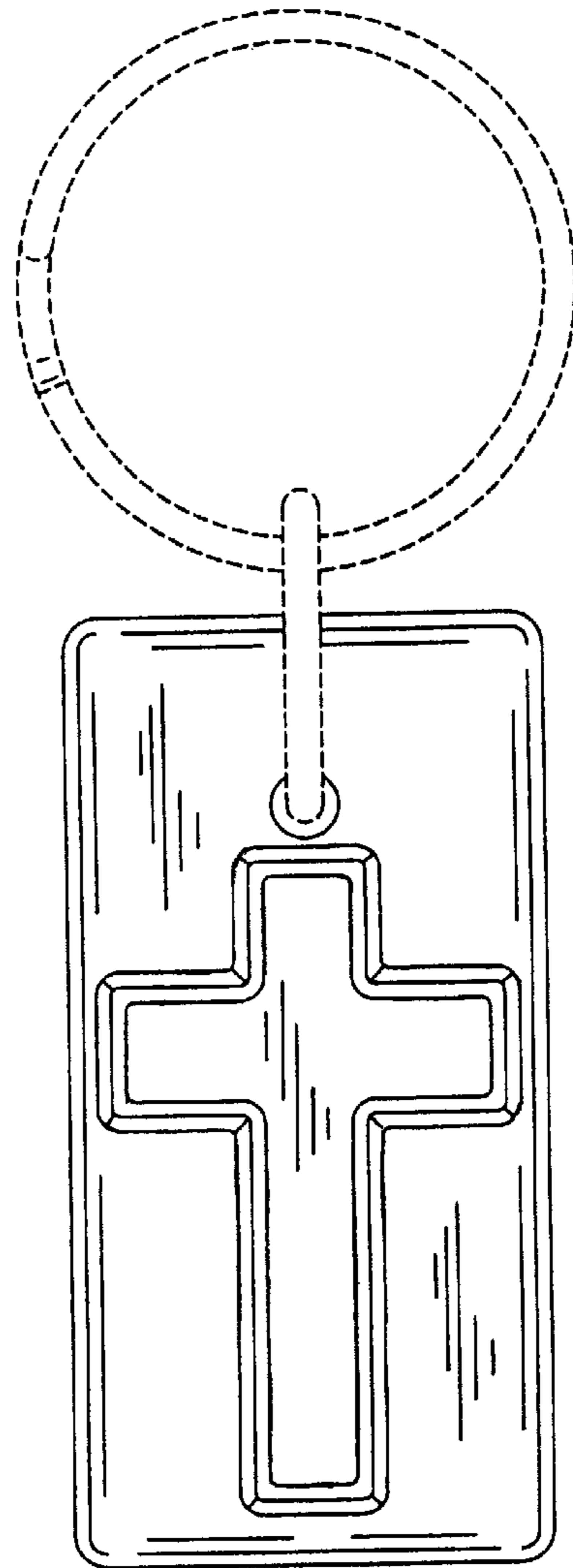

FIG. 2.



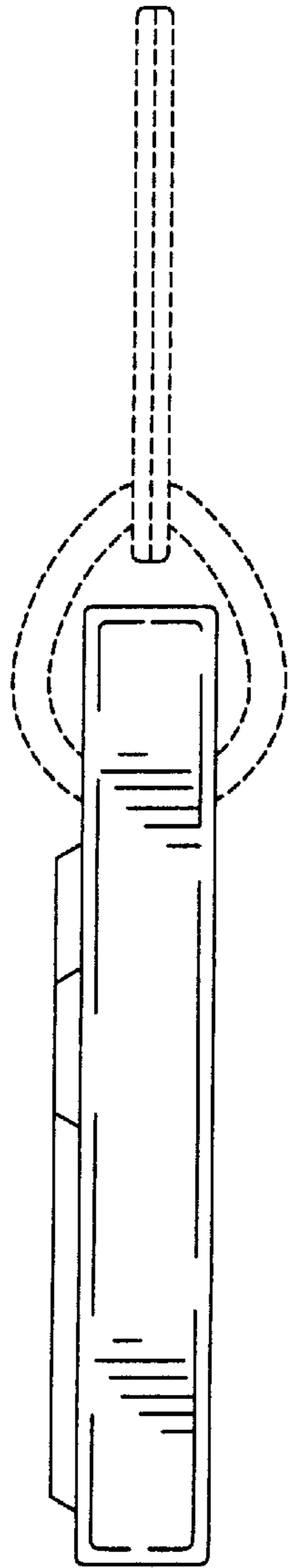

FIG. 3.

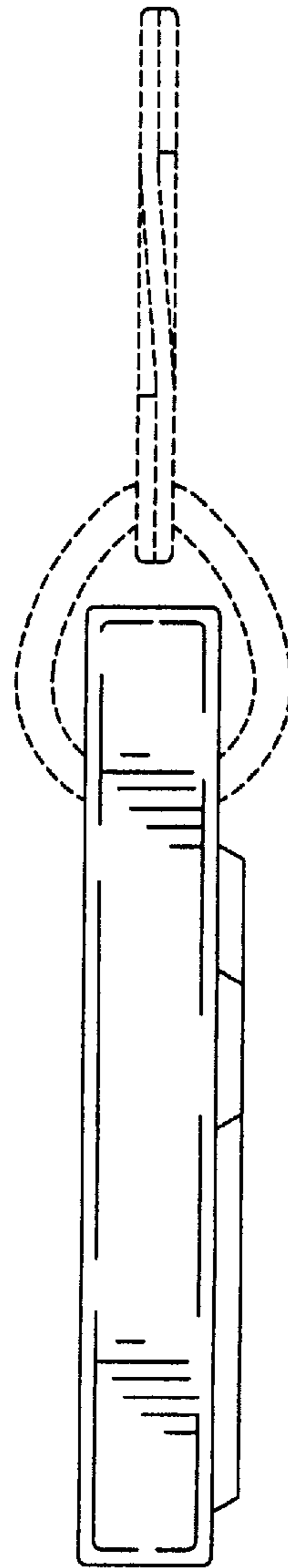

FIG. 4.

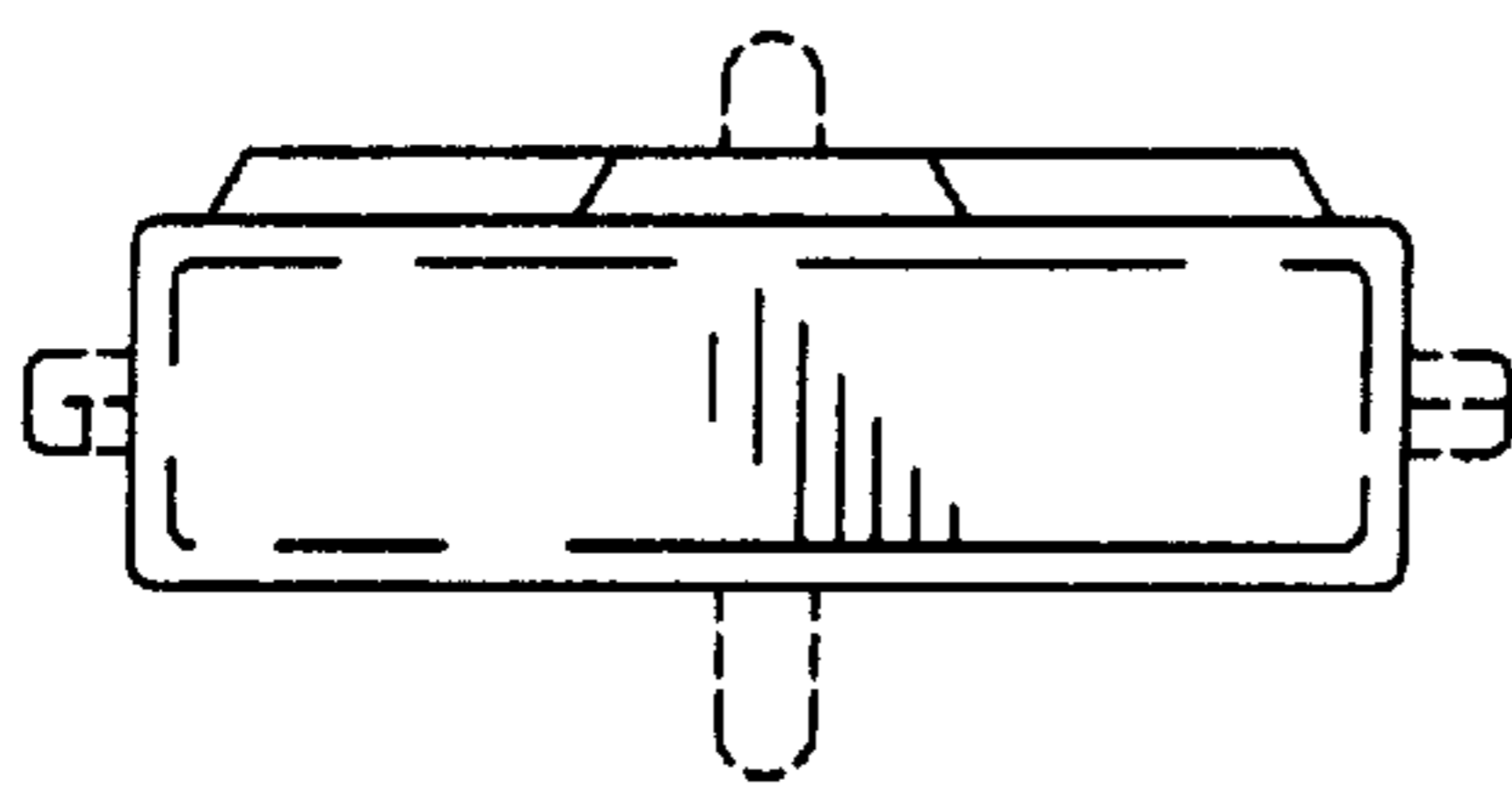

FIG. 5.

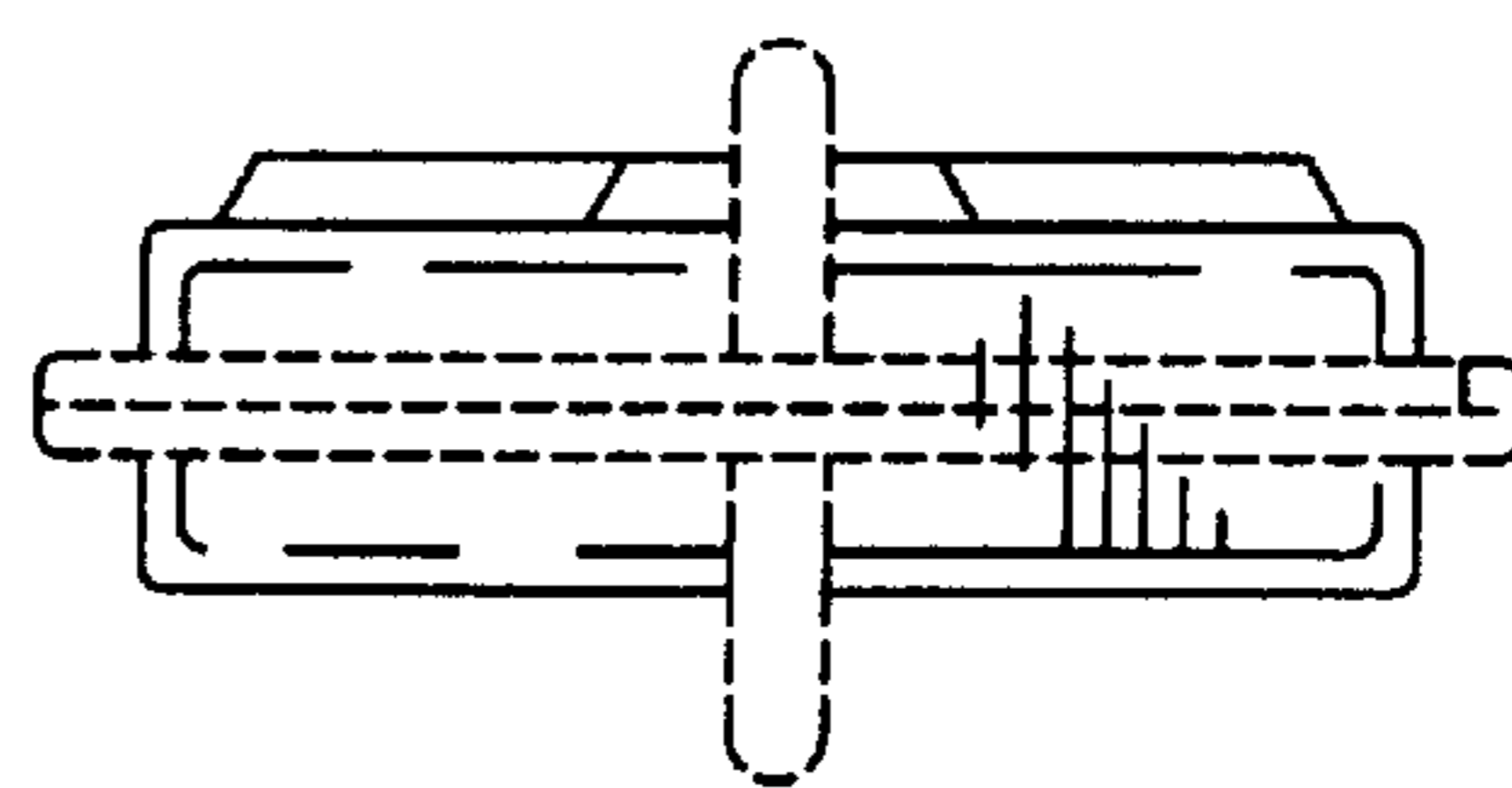

FIG. 6.

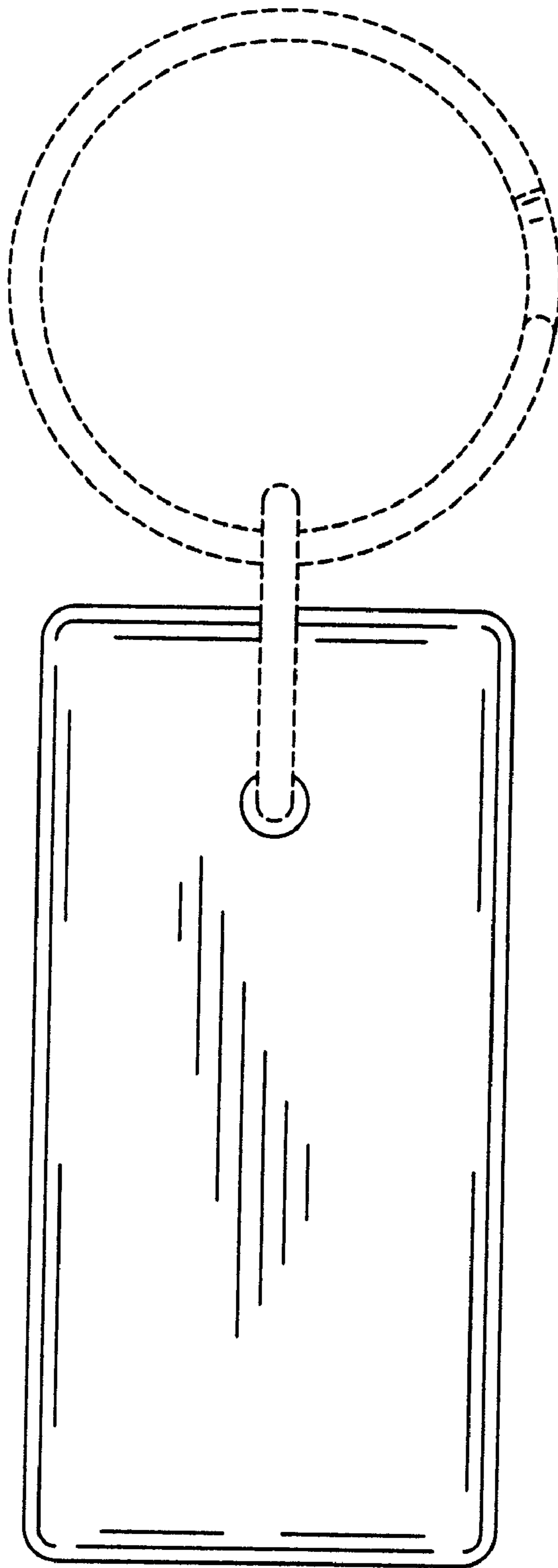

FIG. 7.