



US00D467912S

(12) **United States Design Patent**
Lai et al.

(10) **Patent No.:** **US D467,912 S**

(45) **Date of Patent:** **** Dec. 31, 2002**

(54) **PROTECTIVE COVER FOR DISPLAY(I)**

(75) Inventors: **Cheng-Shing Lai**, Taipei Hsieng (TW);
Zhong-Li Peng, Nanking (CN)

(73) Assignee: **Inventec Appliances Corp.**, Taipei
Hsieng (TW)

(**) Term: **14 Years**

(21) Appl. No.: **29/161,257**

(22) Filed: **May 28, 2002**

(51) **LOC (7) Cl.** **14-03**

(52) **U.S. Cl.** **D14/248; D14/439**

(58) **Field of Search** D14/137, 217,
D14/138, 218, 147-148, 247-248, 144,
336, 337, 341-347, 191; 379/433.01-433.13,
419, 434, 428.01-428.04, 420.01-420.04,
440; D13/163, 171, 174; 455/550-575,
90; D21/517, 331, 333; 361/679, 681, 683;
345/156, 168, 169, 172, 173, 905

(56) **References Cited**

U.S. PATENT DOCUMENTS

D354,478 S	*	1/1995	Miyahara	D14/100
D372,481 S	*	8/1996	Mischenko	D14/249
D389,478 S	*	1/1998	Nagele et al.	D14/138
D394,438 S	*	5/1998	Nagele et al.	D14/248
D395,431 S	*	6/1998	Harris et al.	D14/138
D401,914 S	*	12/1998	Kamegi	D14/100
D408,021 S	*	4/1999	Haitani et al.	D14/100
D408,030 S	*	4/1999	Richards et al.	D14/138

D410,486 S	*	6/1999	Takahata et al.	D18/2
D417,657 S	*	12/1999	Matsumoto	D14/100
D421,435 S	*	3/2000	Haase et al.	D14/137
D425,056 S	*	5/2000	Edwards et al.	D14/138
D431,558 S	*	10/2000	Winstead et al.	D14/248
D432,535 S	*	10/2000	Loh et al.	D14/345
D433,016 S	*	10/2000	Matsuda et al.	D14/345
D446,196 S	*	8/2001	Chamberlain et al.	D14/137
D446,199 S	*	8/2001	Xu et al.	D14/138
D450,307 S	*	11/2001	Xu et al.	D14/138
D452,968 S	*	1/2002	Evers et al.	D14/345
D455,135 S	*	4/2002	Hyun	D14/138
D456,394 S	*	4/2002	Laverick et al.	D14/248
D458,268 S	*	6/2002	Lee	D14/439

* cited by examiner

Primary Examiner—Jeffrey Asch

(74) *Attorney, Agent, or Firm*—Bacon & Thomas, PLLC

(57) **CLAIM**

The ornamental design for protective cover for display(I), as shown and described.

DESCRIPTION

FIG. 1 is a perspective view of protective cover for display(I) showing my new design.
FIG. 2 is a front elevational view thereof;
FIG. 3 is a rear elevational view thereof;
FIG. 4 is a left side elevational view thereof;
FIG. 5 is a right side elevational view thereof;
FIG. 6 is a top plan view thereof; and,
FIG. 7 is a bottom plan view thereof.

1 Claim, 5 Drawing Sheets

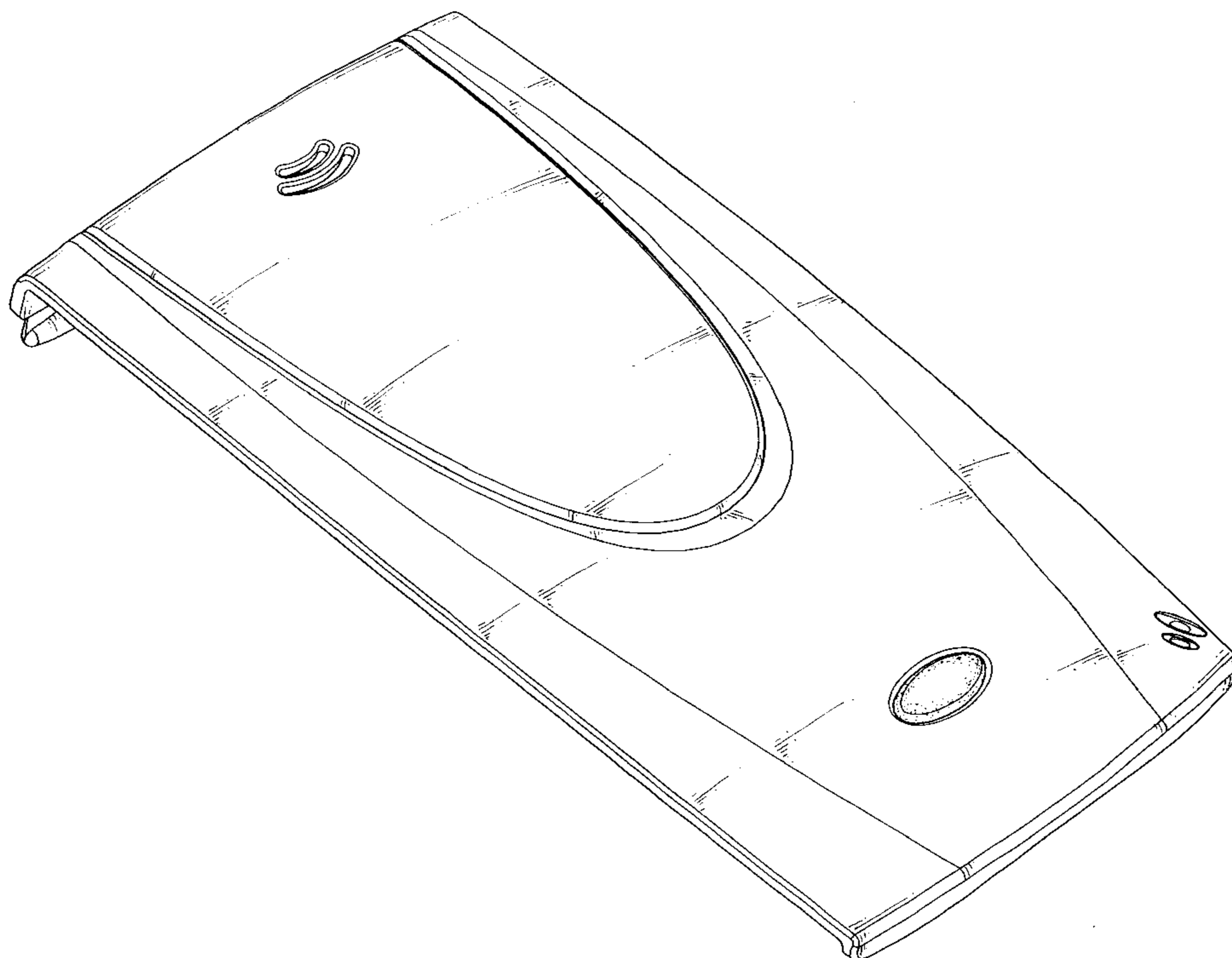

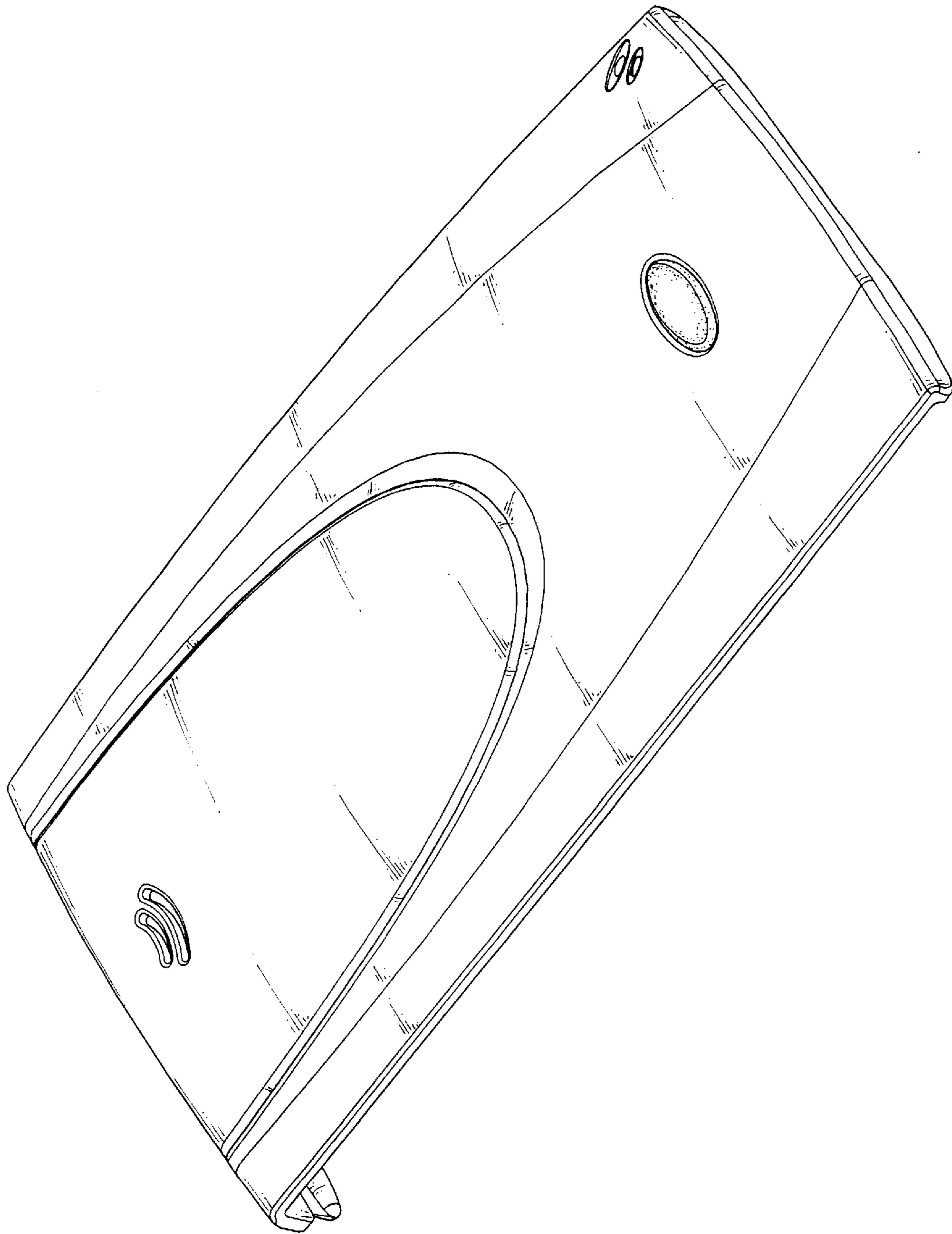

FIG. 1

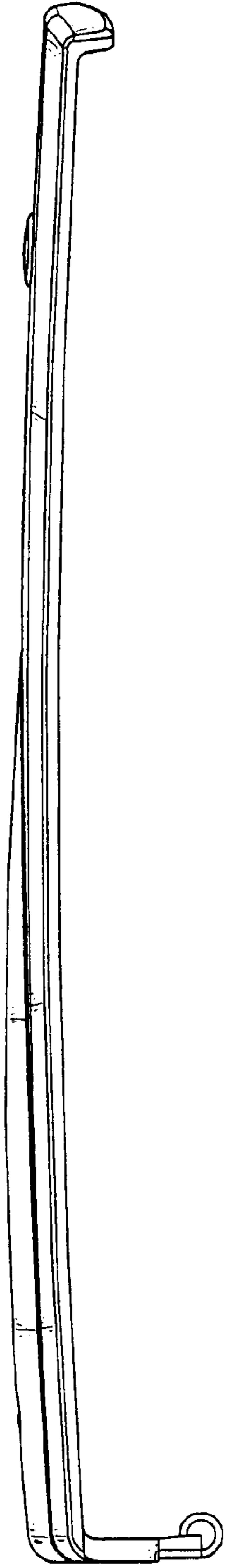

FIG. 2

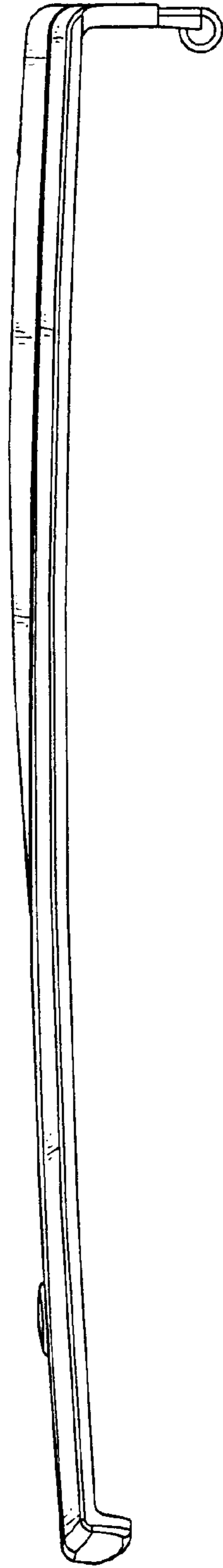

FIG. 3

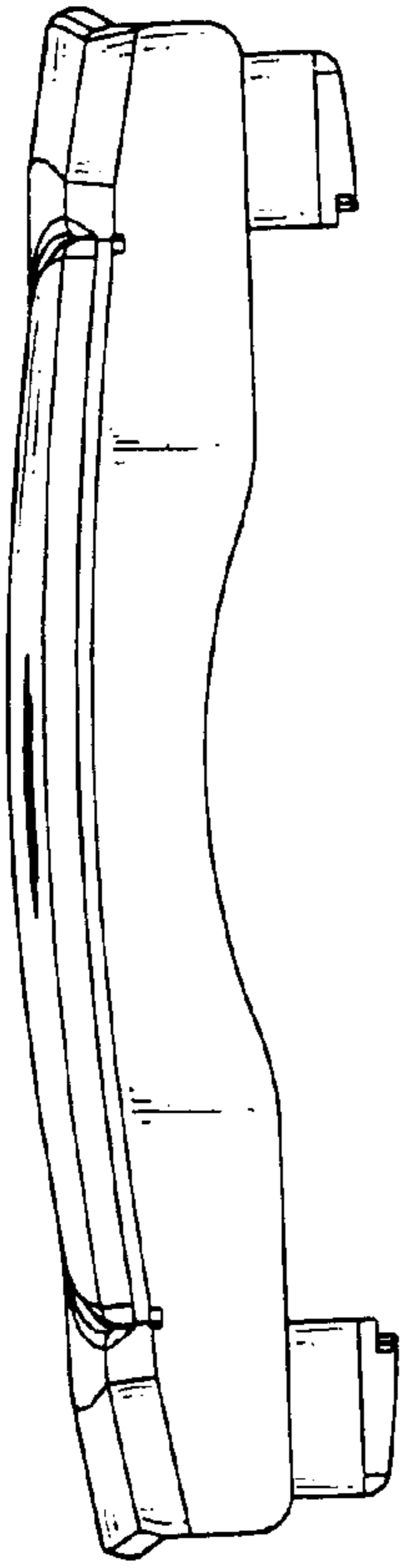

FIG. 4



FIG. 5

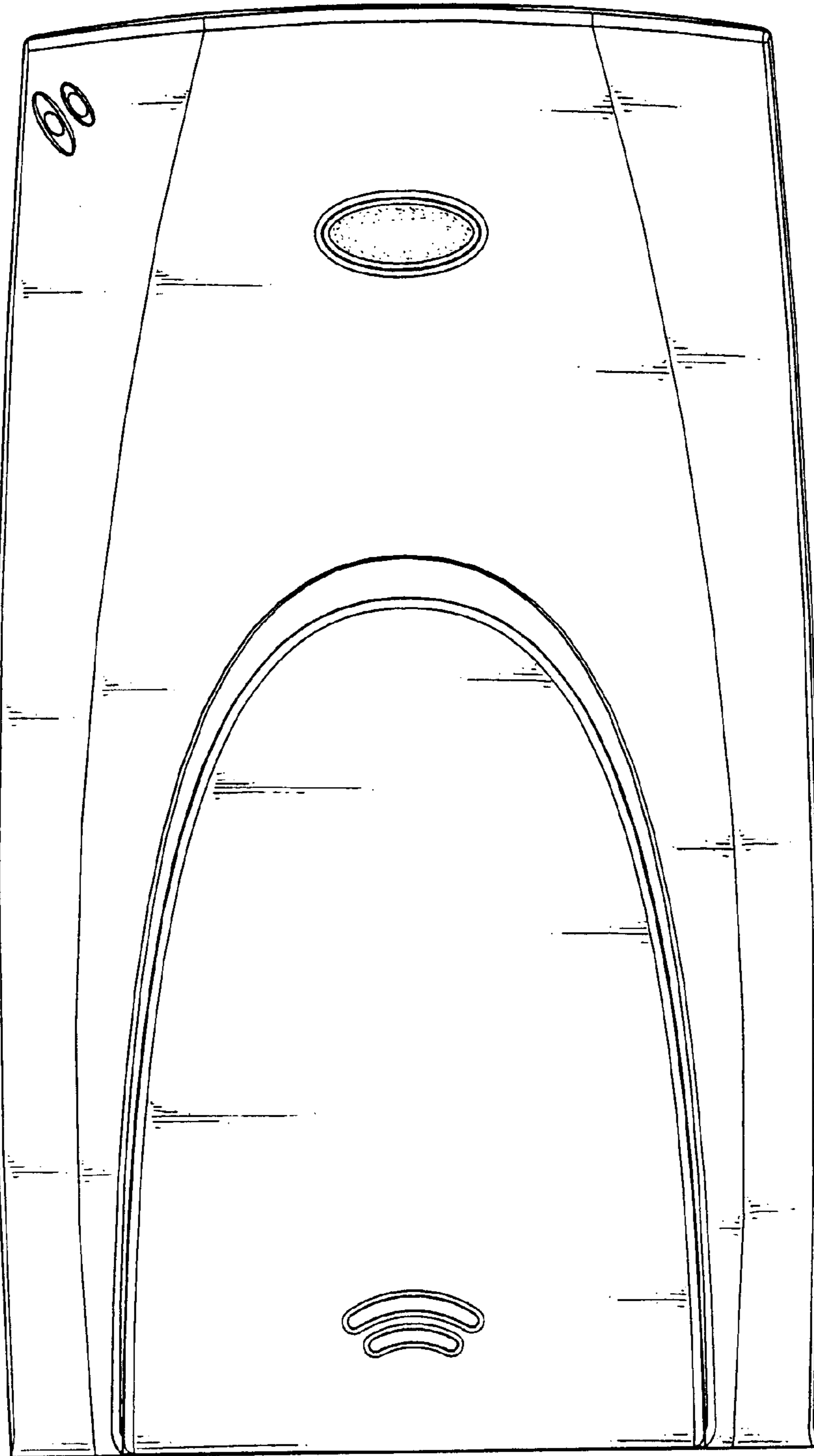

FIG. 6

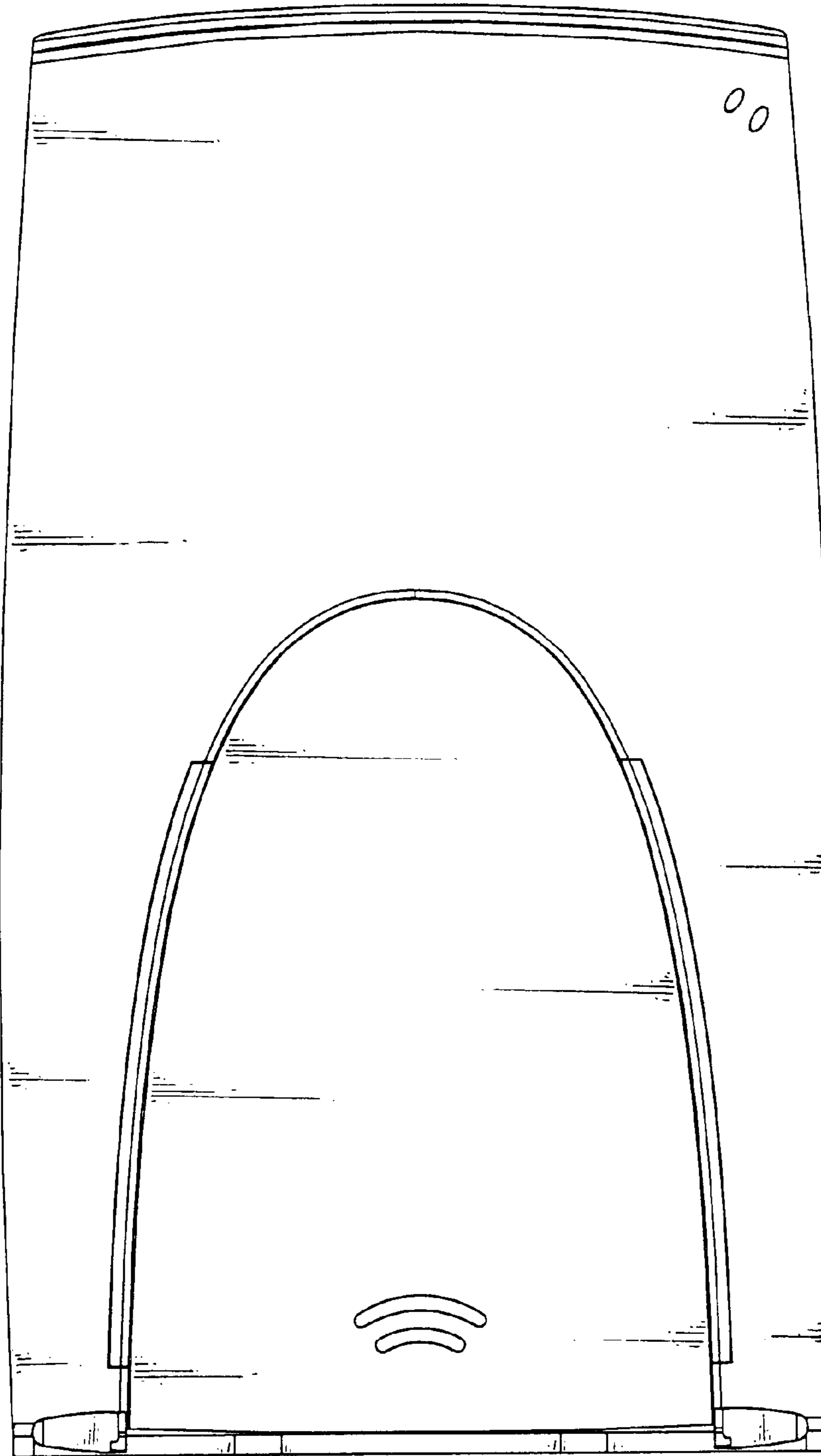

FIG. 7