



US00D467838S

(12) **United States Design Patent**  
**Yoshiguchi**

(10) **Patent No.:** **US D467,838 S**

(45) **Date of Patent:** **\*\* Dec. 31, 2002**

(54) **BUCKLE**

(75) **Inventor:** **Manabu Yoshiguchi, Kanagawa-ken (JP)**

(73) **Assignee:** **Nifco Inc., Yokohama (JP)**

(\*\*) **Term:** **14 Years**

(21) **Appl. No.:** **29/164,296**

(22) **Filed:** **Jul. 23, 2002**

(30) **Foreign Application Priority Data**

Feb. 8, 2002 (JP) ..... 2002-003144

(51) **LOC (7) Cl.** ..... **02-07**

(52) **U.S. Cl.** ..... **D11/218**

(58) **Field of Search** ..... D11/218, 200, D11/216; 24/198, 196, 200; D8/383

(56) **References Cited**

**U.S. PATENT DOCUMENTS**

D340,008 S \* 10/1993 Anscher ..... D11/218

D356,491 S \* 3/1995 Anscher ..... D8/383

5,651,166 A \* 7/1997 Lundstedt ..... 24/200

D399,172 S \* 10/1998 Anscher ..... D11/218

D458,870 S \* 6/2002 Anscher ..... D11/218

\* cited by examiner

*Primary Examiner*—Louis S. Zarfes

*Assistant Examiner*—Gregory Andoll

(74) *Attorney, Agent, or Firm*—Kanesaka & Takeuchi

(57) **CLAIM**

The ornamental design for a buckle, as shown and described.

**DESCRIPTION**

FIG. 1 is a perspective view of a buckle showing my new design;

FIG. 2 is a front view thereof;

FIG. 3 is a rear view thereof;

FIG. 4 is a right side view thereof, the left side view being symmetrical to the right side view;

FIG. 5 is a top plan view thereof;

FIG. 6 is a bottom plan view thereof; and,

FIG. 7 is a cross sectional view taken along line 7—7 in FIG. 2.

**1 Claim, 4 Drawing Sheets**

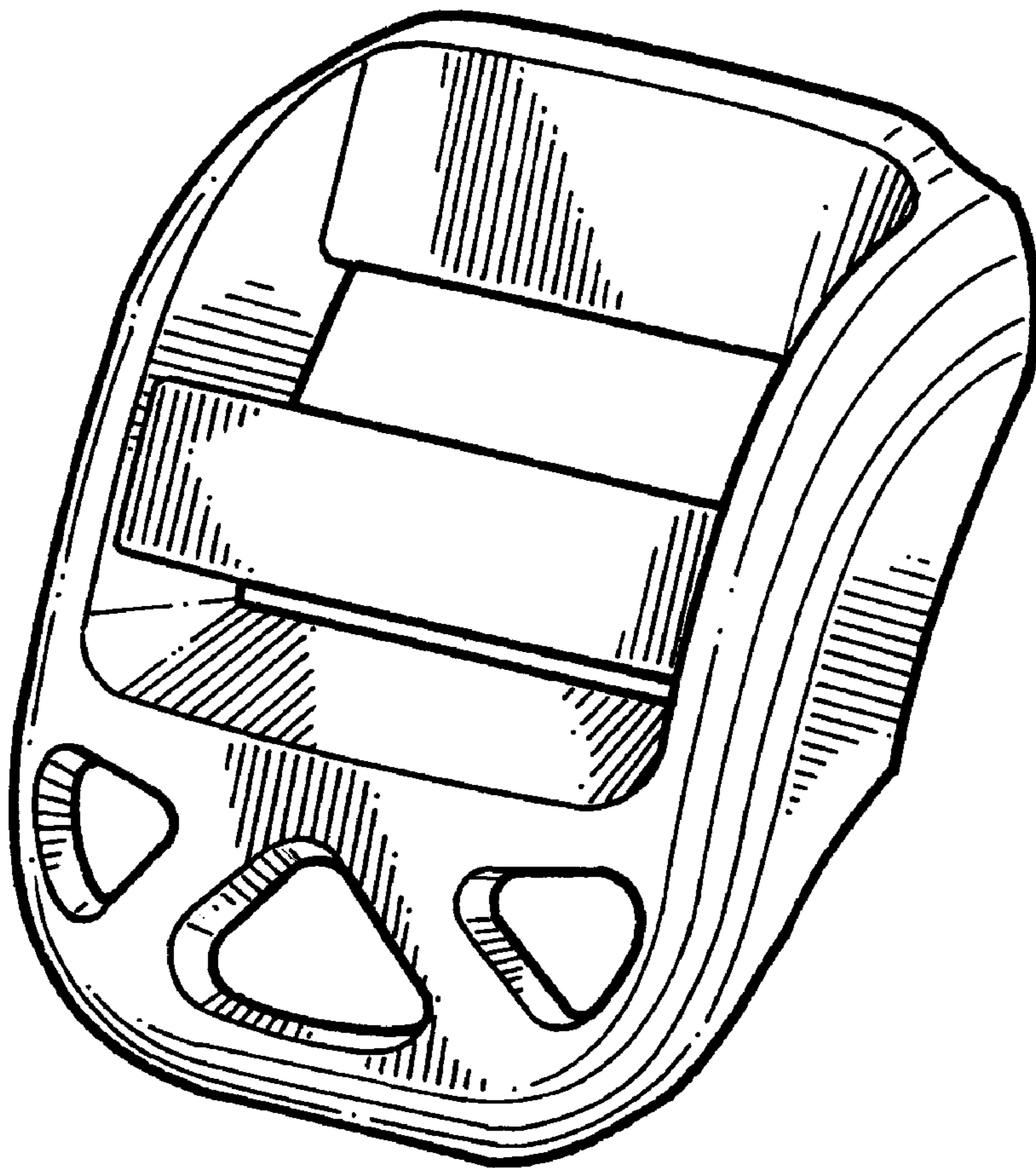

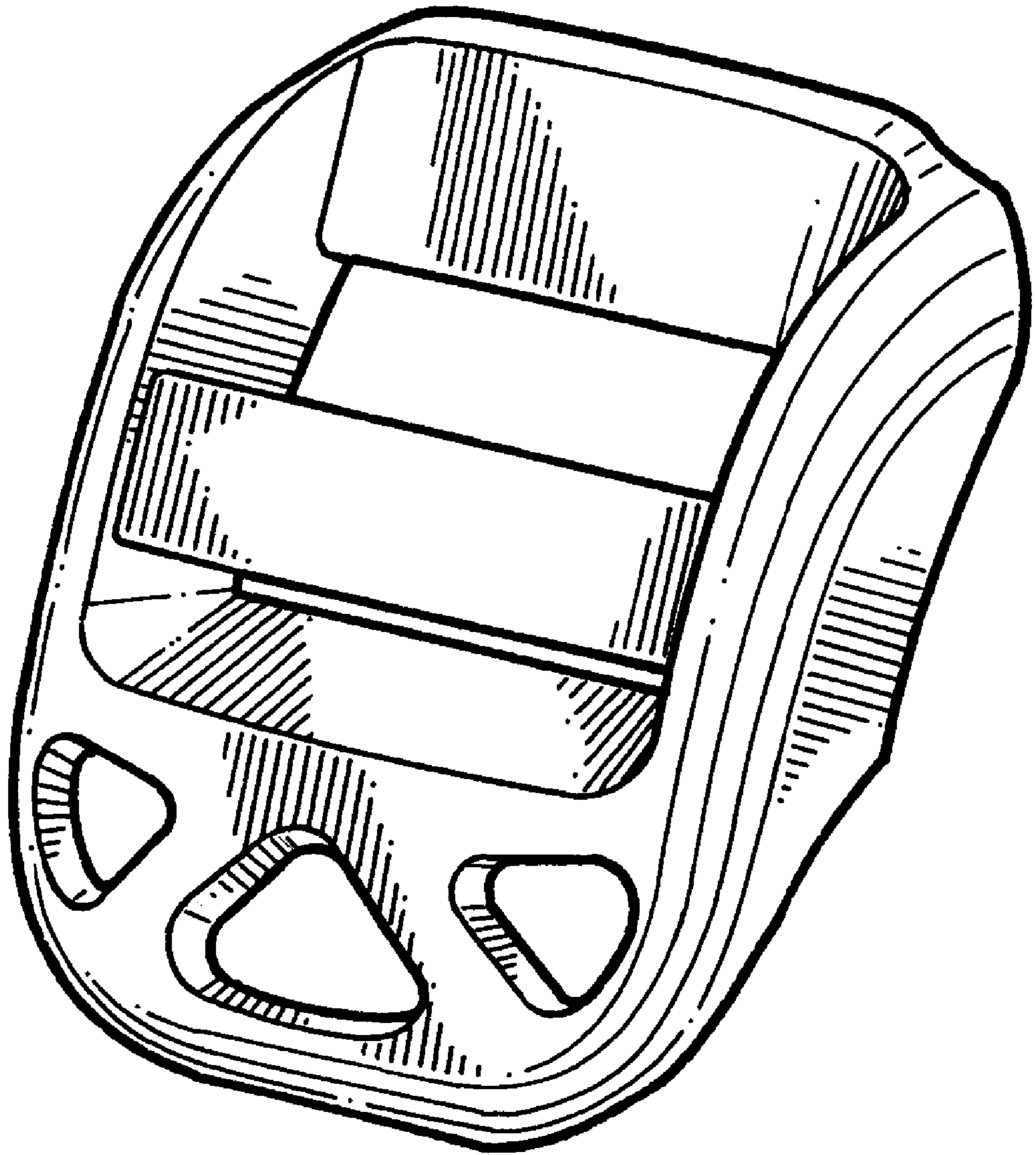

FIG. 1

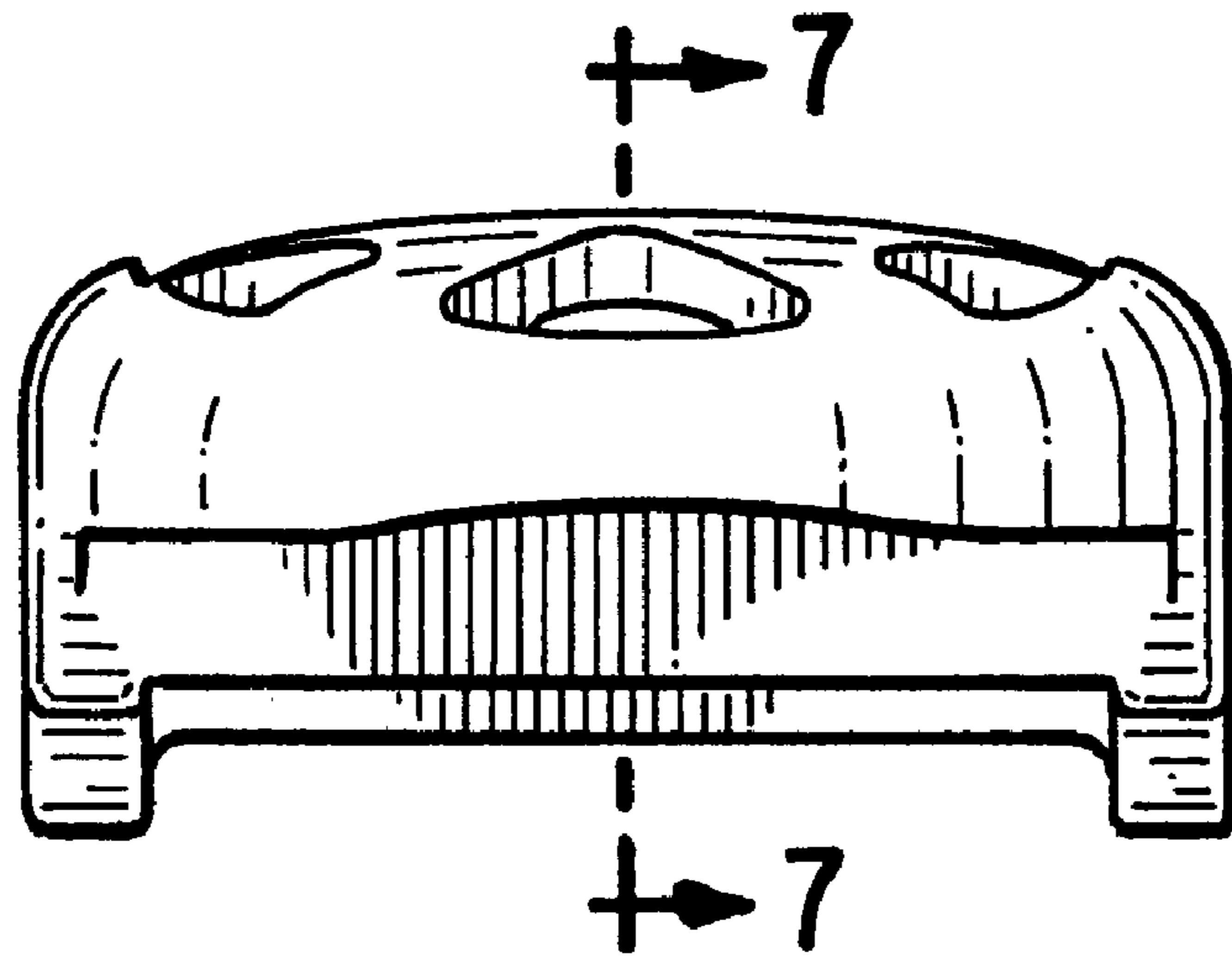

FIG. 2

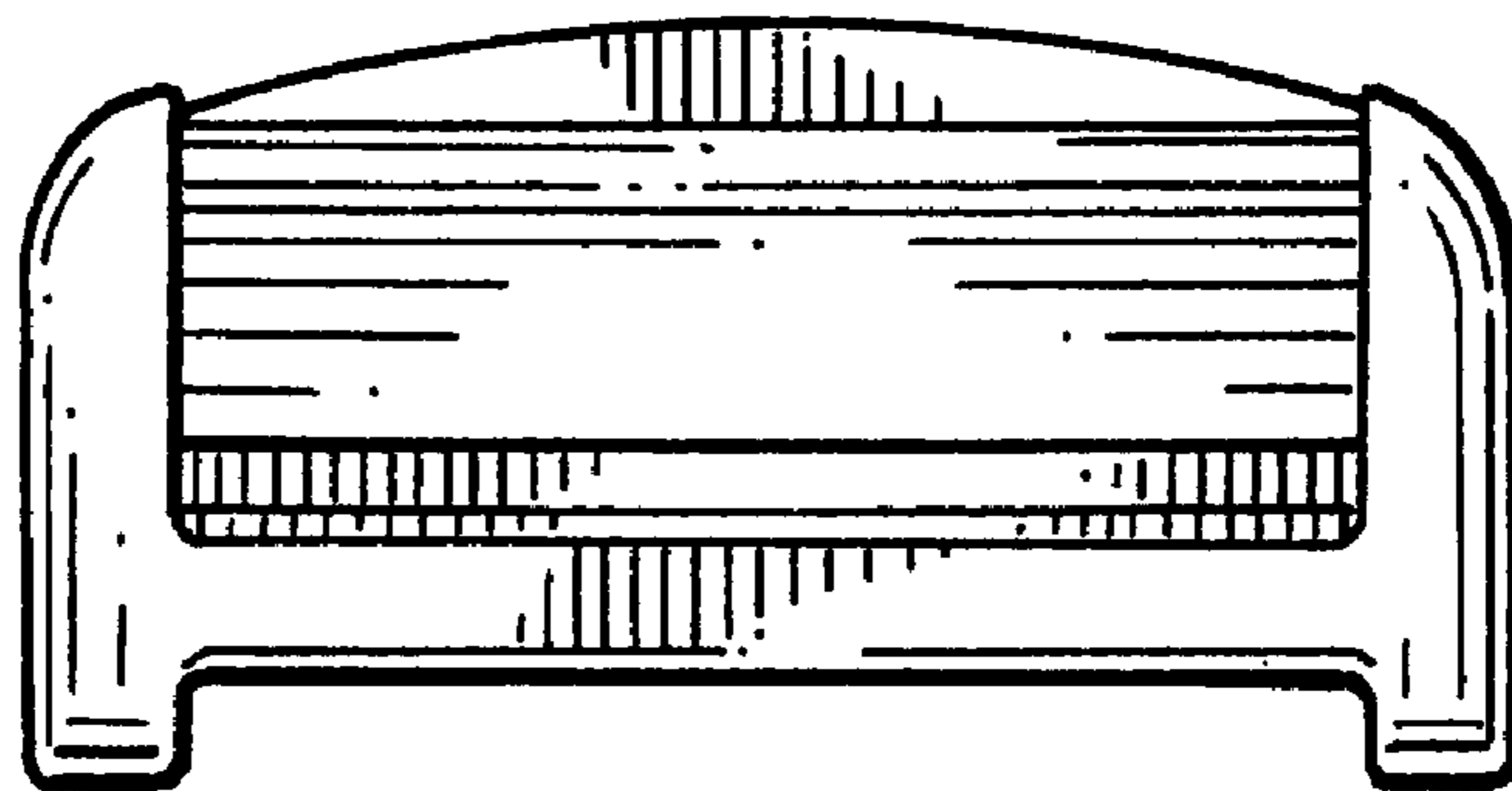

FIG. 3

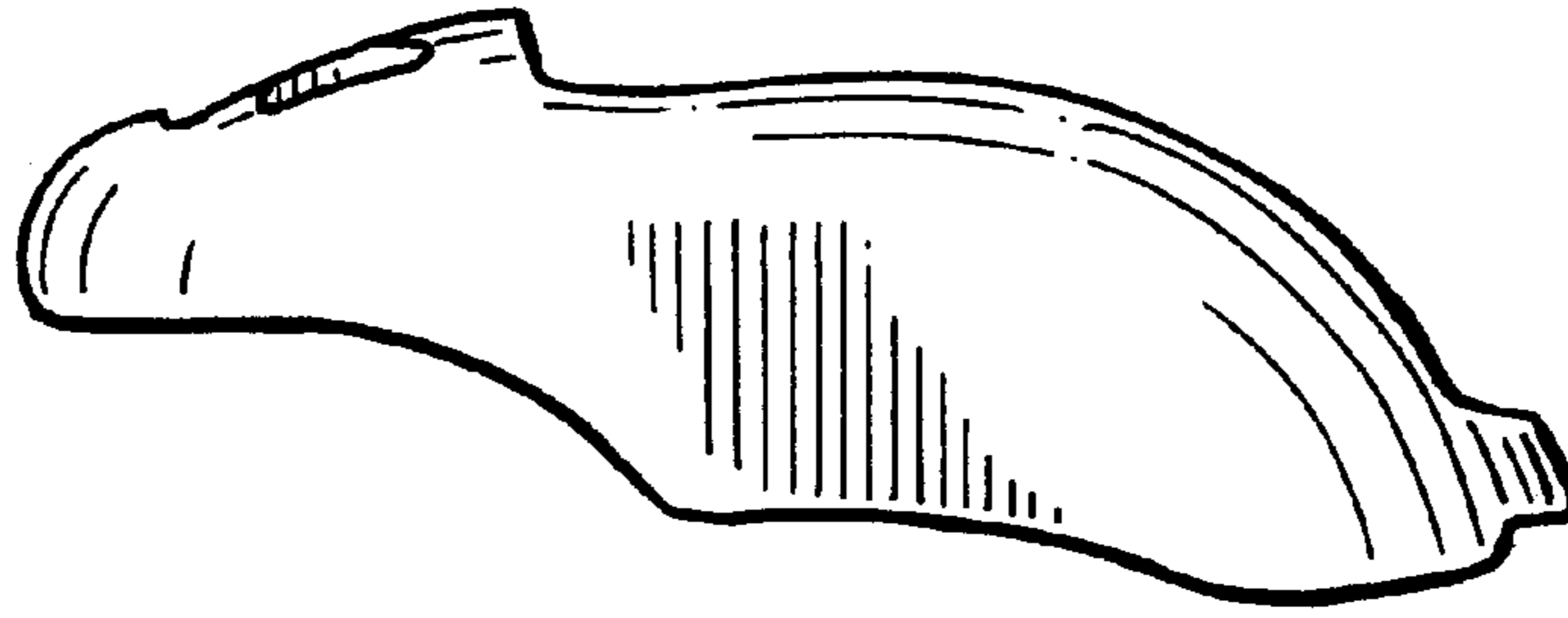

FIG. 4

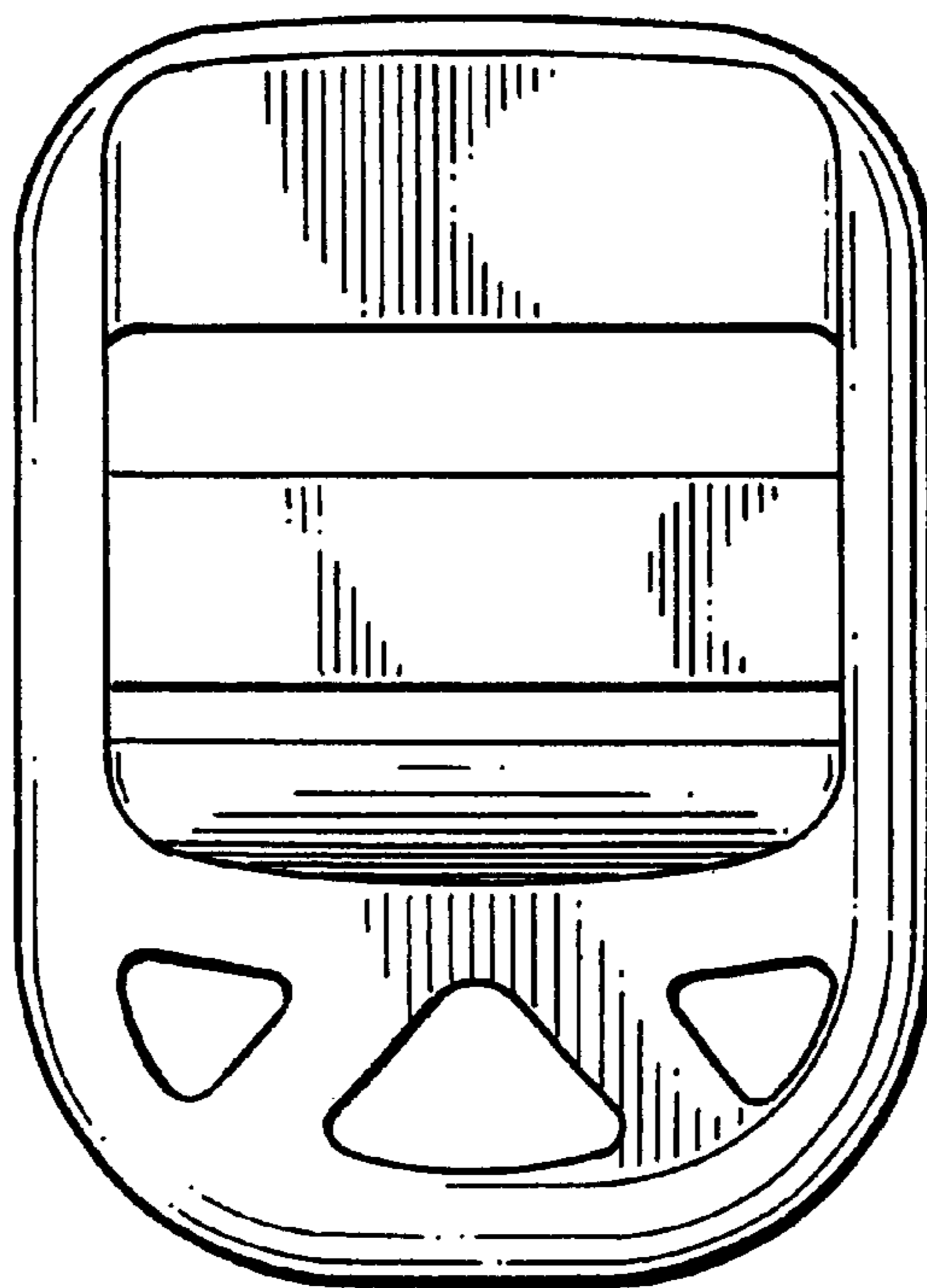

FIG. 5

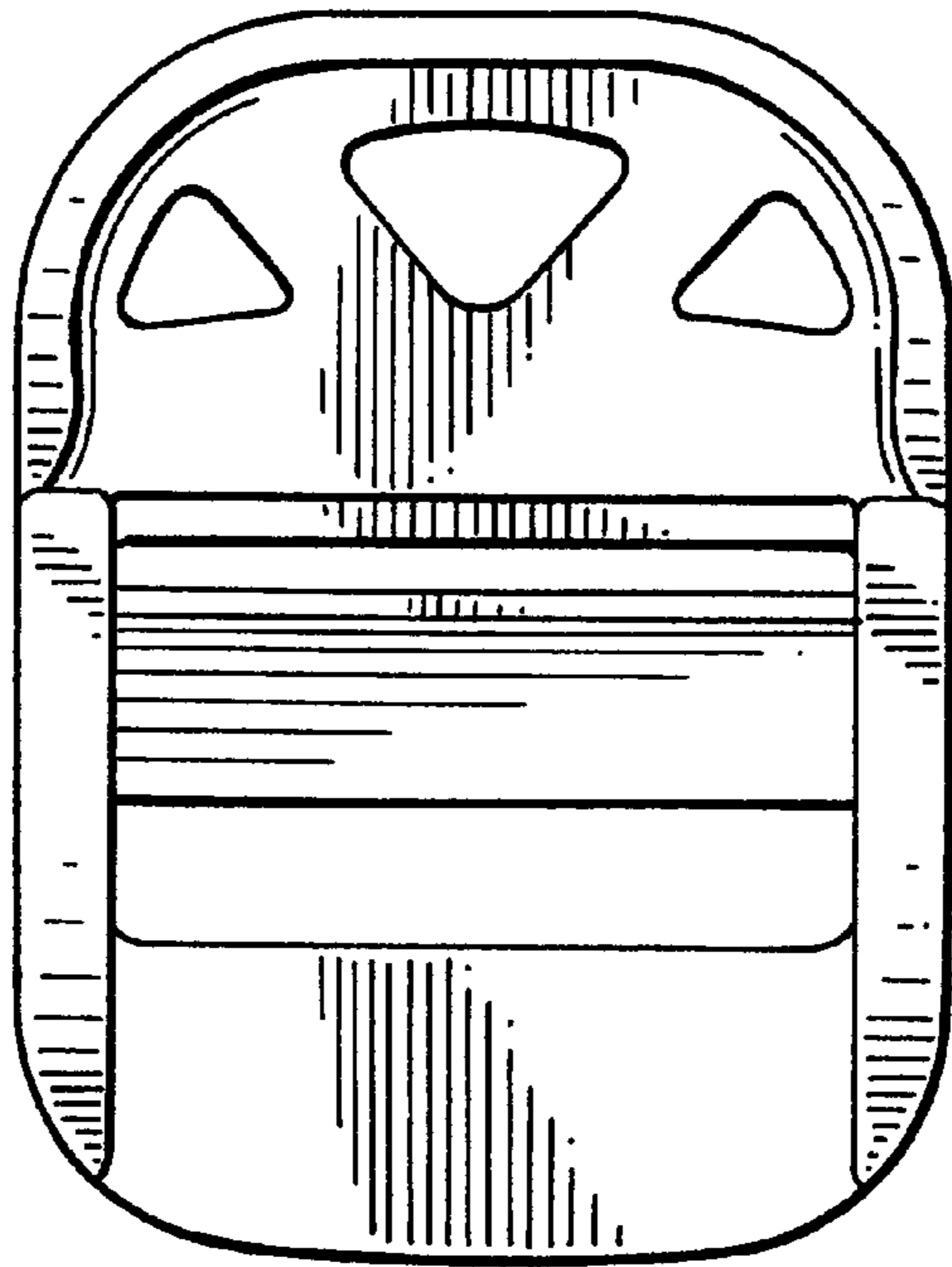

FIG. 6

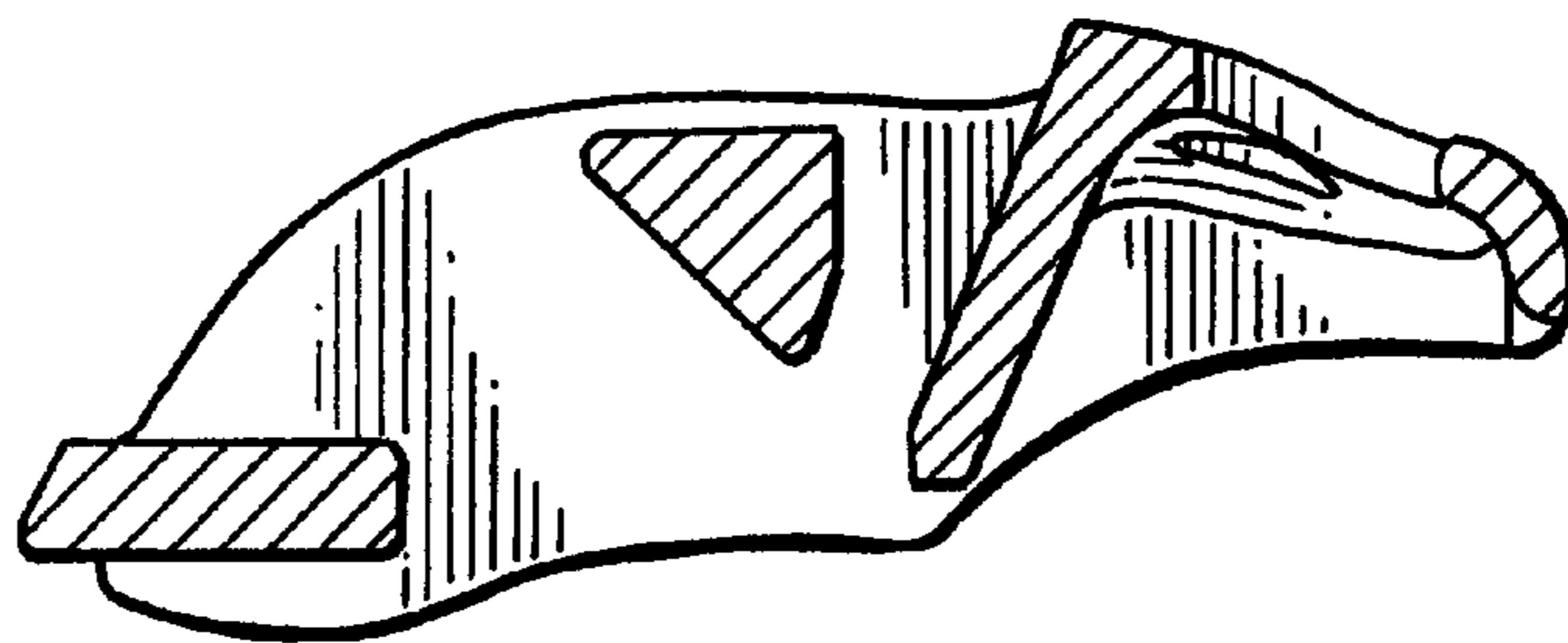

FIG. 7