



US00D467813S

(12) **United States Design Patent**  
**Silvers et al.**

(10) **Patent No.:** **US D467,813 S**

(45) **Date of Patent:** **\*\* Dec. 31, 2002**

(54) **CONTAINER**

D452,445 S \* 12/2001 Silvers et al. .... D9/538

(75) Inventors: **Kerry W. Silvers**, Chelsea, MI (US);  
**Richard J. Steih**, Britton, MI (US)

\* cited by examiner

(73) Assignee: **Schmalbach-Lubeca AG** (DE)

*Primary Examiner*—Ted Shooman

(\*\*) Term: **14 Years**

*Assistant Examiner*—Daniel Bui

(21) Appl. No.: **29/148,046**

(74) *Attorney, Agent, or Firm*—Harness, Dickey & Pierce,  
P.L.C.

(22) Filed: **Sep. 13, 2001**

(57) **CLAIM**

(51) **LOC (7) Cl.** ..... **09-03**

The ornamental design for a container, as shown and described.

(52) **U.S. Cl.** ..... **D9/538; D9/559**

**DESCRIPTION**

(58) **Field of Search** ..... D9/516, 530, 537,  
D9/543, 549, 559, 566, 575, 499; 206/527;  
215/200, 316, 329, 354, 400; 220/200,  
260, 288, 289, 890; 221/312 R; 222/575

FIG. 1 is a rear perspective view of a container showing our new design;

FIG. 2 is a top plan view of the container shown in FIG. 1;

FIG. 3 is a front elevational view of the container shown in FIG. 1;

FIG. 4 is a bottom view of the container shown in FIG. 1;

FIG. 5 is a left side view of the container shown in FIG. 1,

the right side being a mirror image of the left side shown;

FIG. 6 is a rear elevational view of the container shown in FIG. 1; and,

FIG. 7 is a cross-sectional view of the container along line 7—7 of FIG. 6.

The broken lines are for environmental purposes only and form no part of the claimed design.

The outer most broken line circle on FIG. 4 defines the boundary of the claim but is not a part thereof.

(56) **References Cited**

**U.S. PATENT DOCUMENTS**

D299,314 S	*	1/1989	LeFevre	.....	D9/520
D382,807 S		8/1997	Silvers et al.		
D423,936 S		5/2000	Smith et al.		
D424,446 S		5/2000	Silvers et al.		
D425,425 S		5/2000	Silvers et al.		
D428,815 S		8/2000	Mooney et al.		
D439,166 S	*	3/2001	Denner et al.	.....	D9/538
D442,866 S	*	5/2001	Mooney et al.	.....	D9/520
D443,521 S	*	6/2001	Bansal et al.	.....	D9/543
D448,674 S	*	10/2001	Mooney	.....	D9/540

**1 Claim, 4 Drawing Sheets**

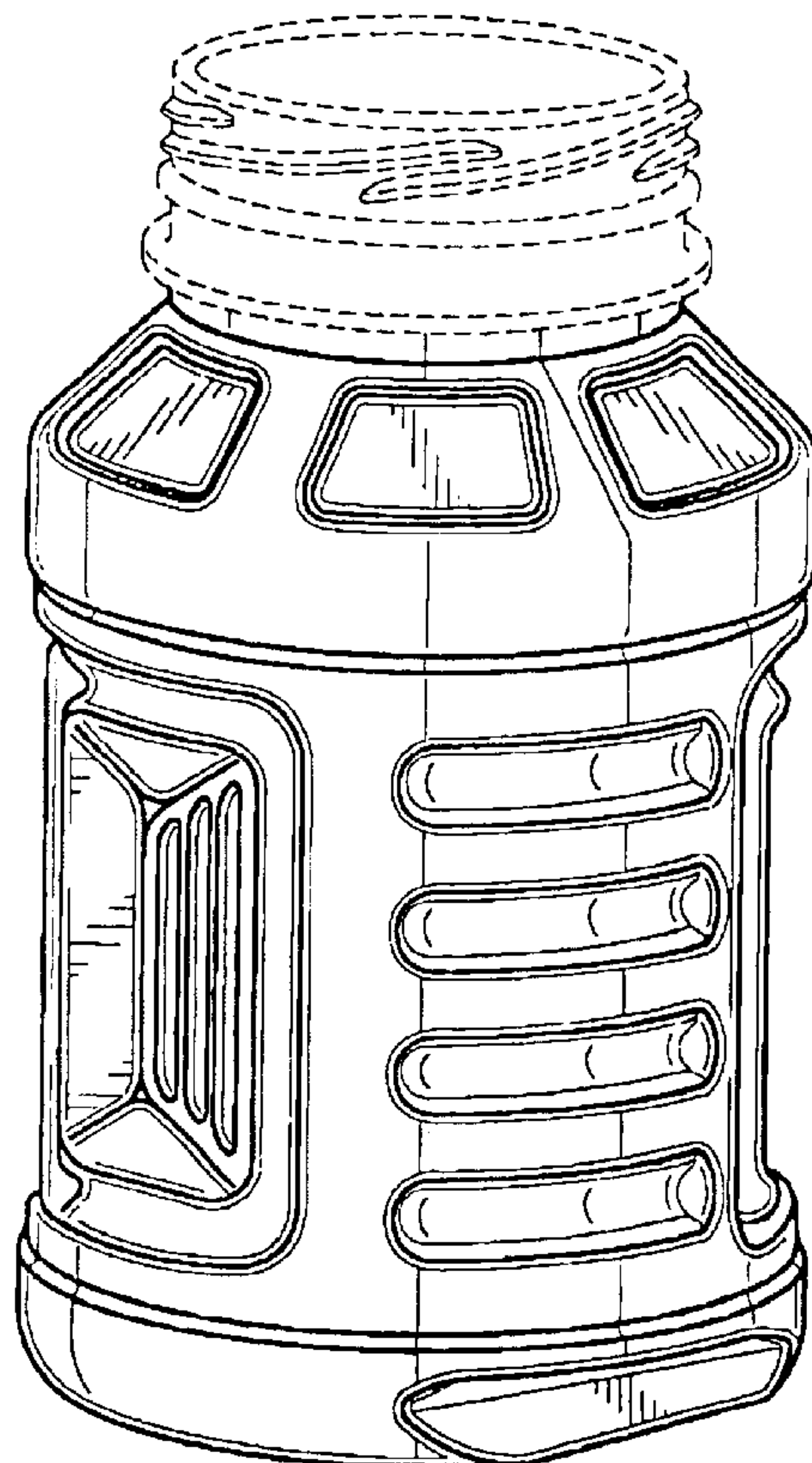

*FIG. 1*

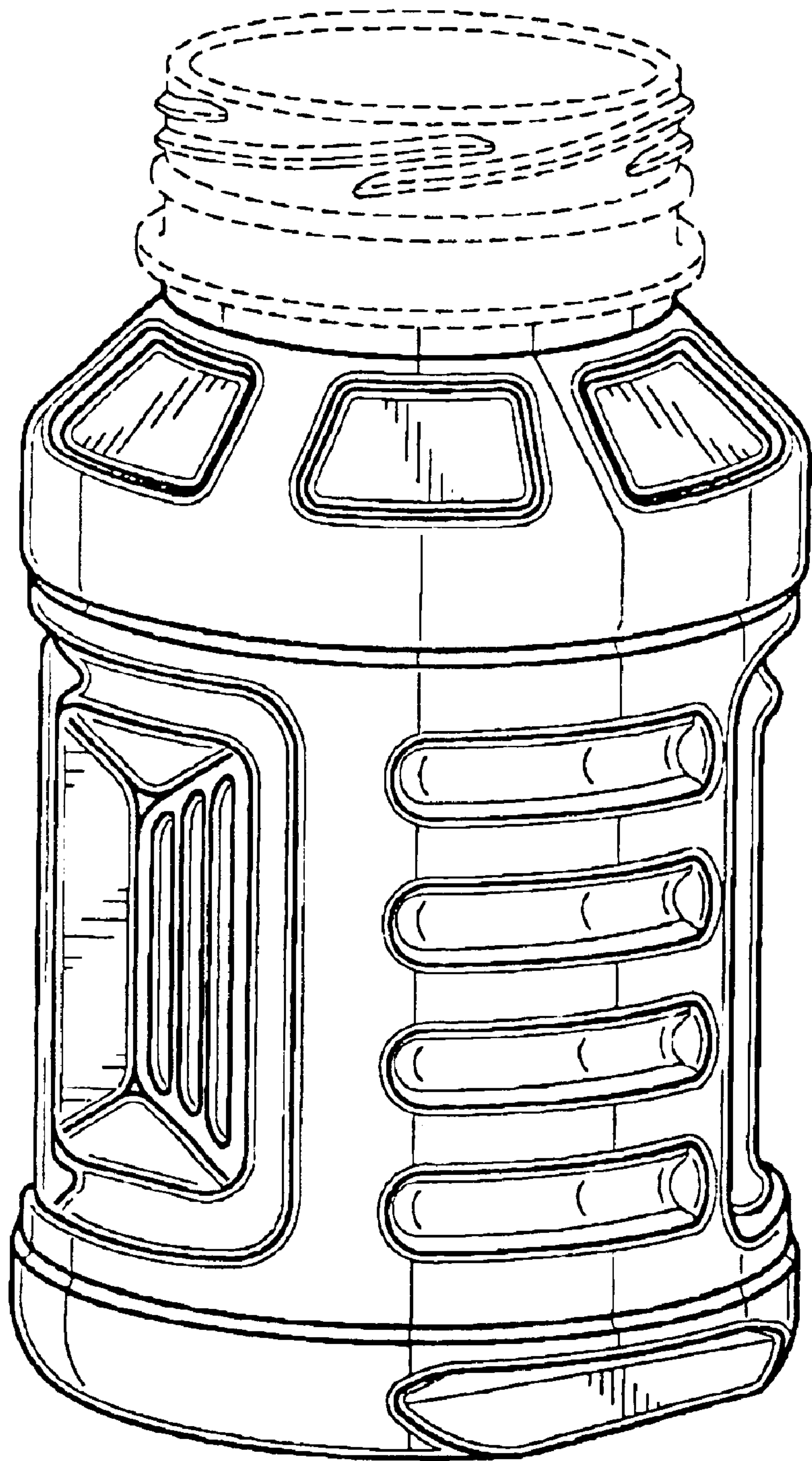

FIG. 2

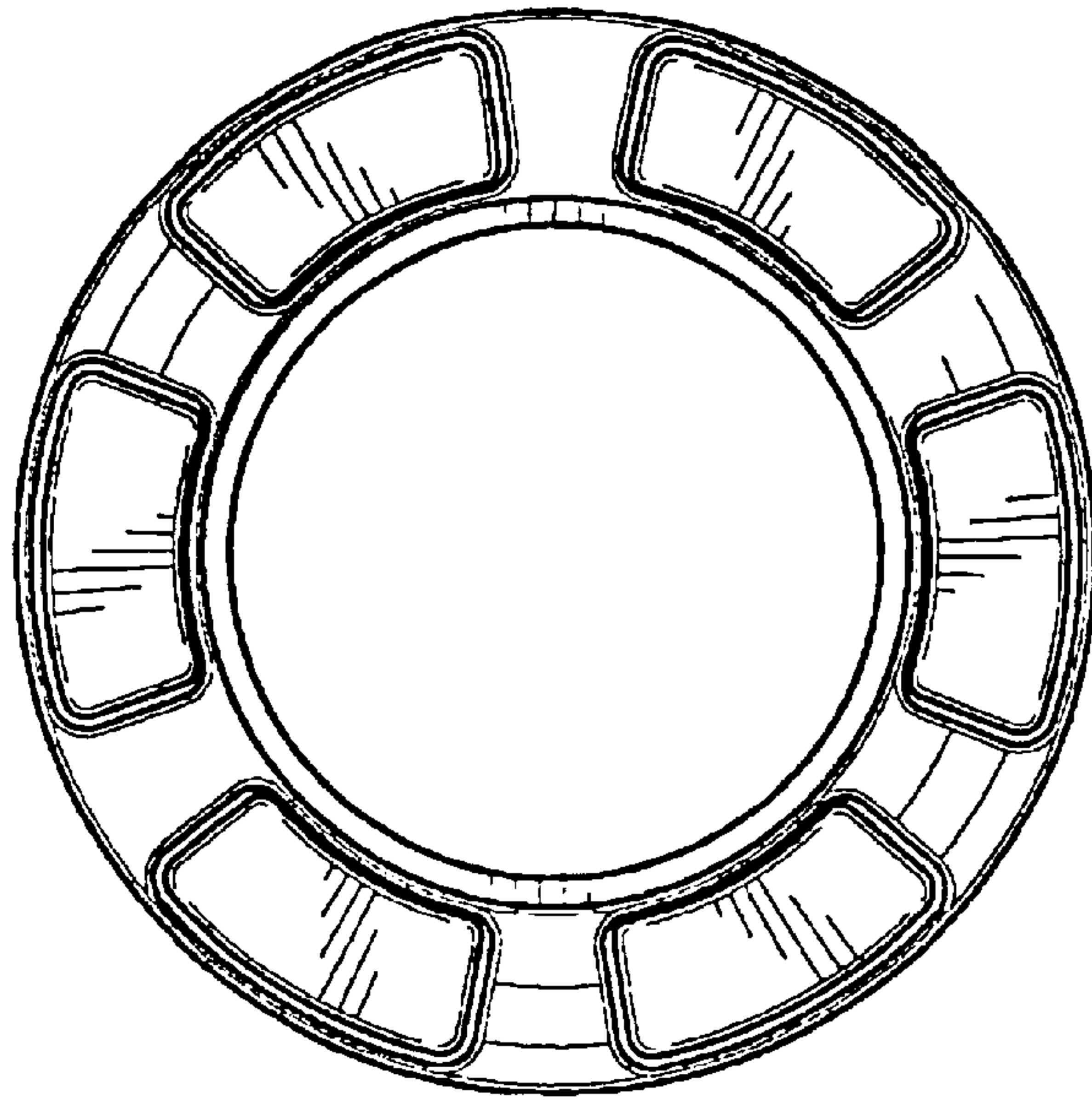

FIG. 3

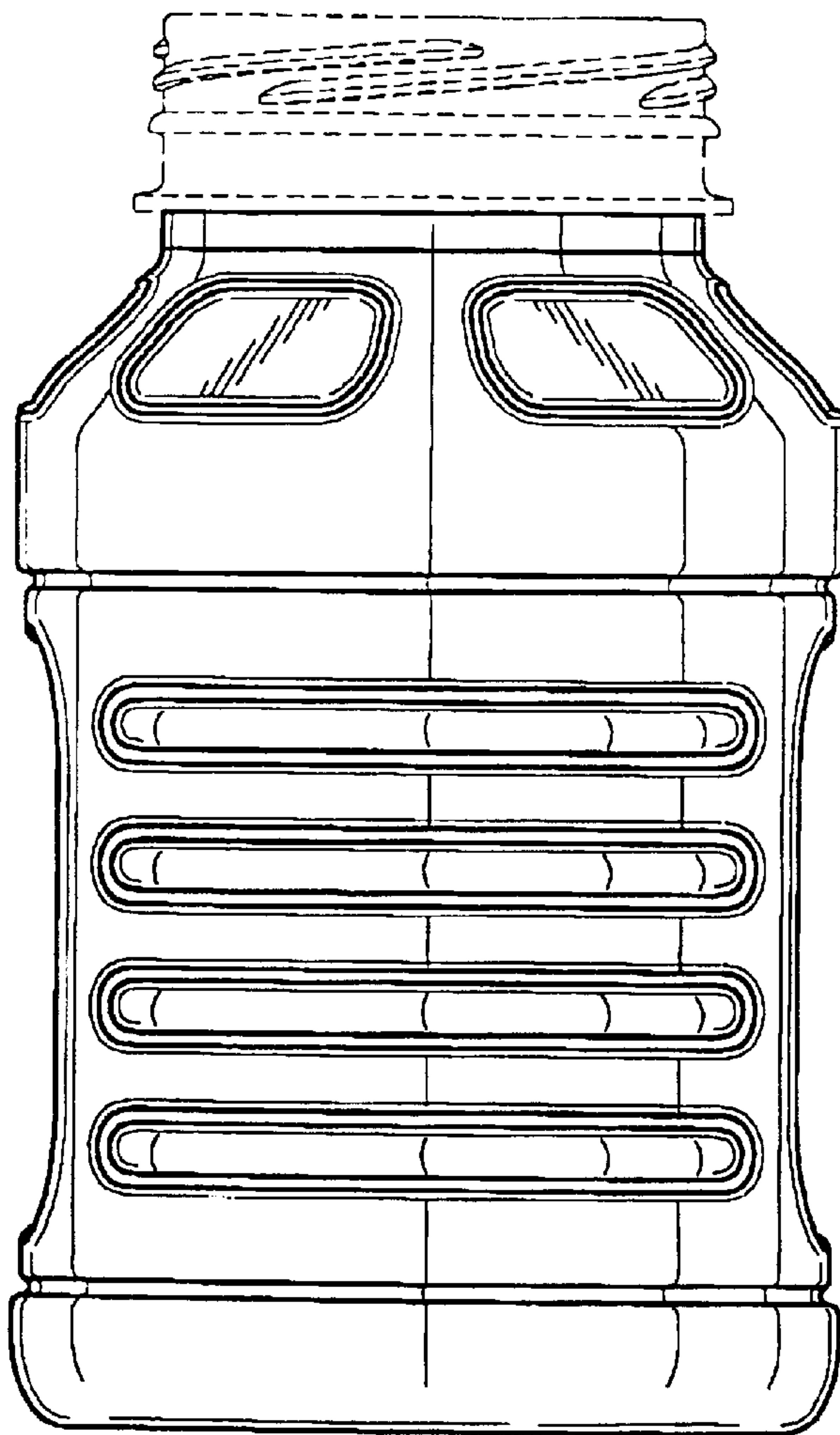



FIG. 4

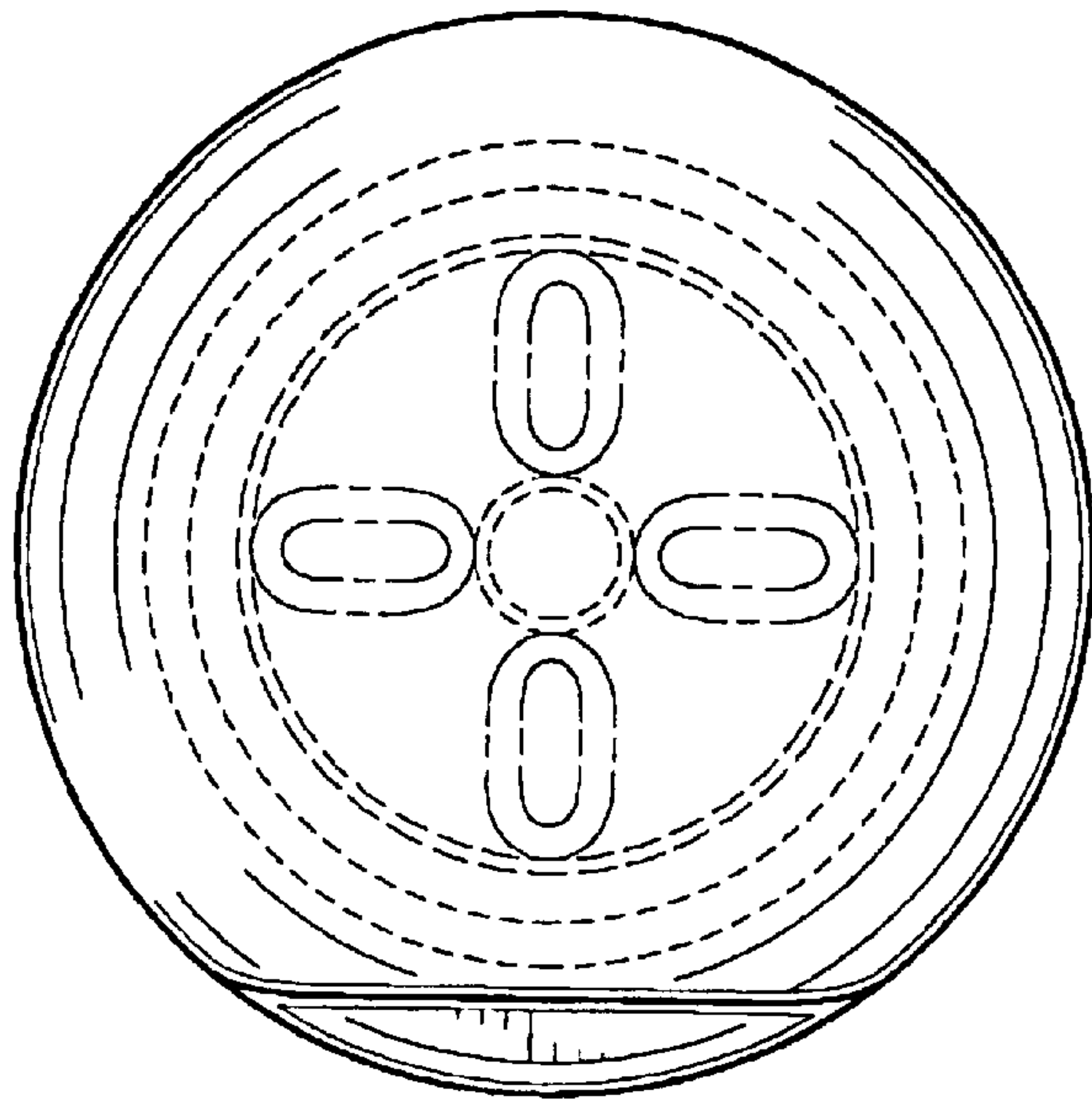

FIG. 5

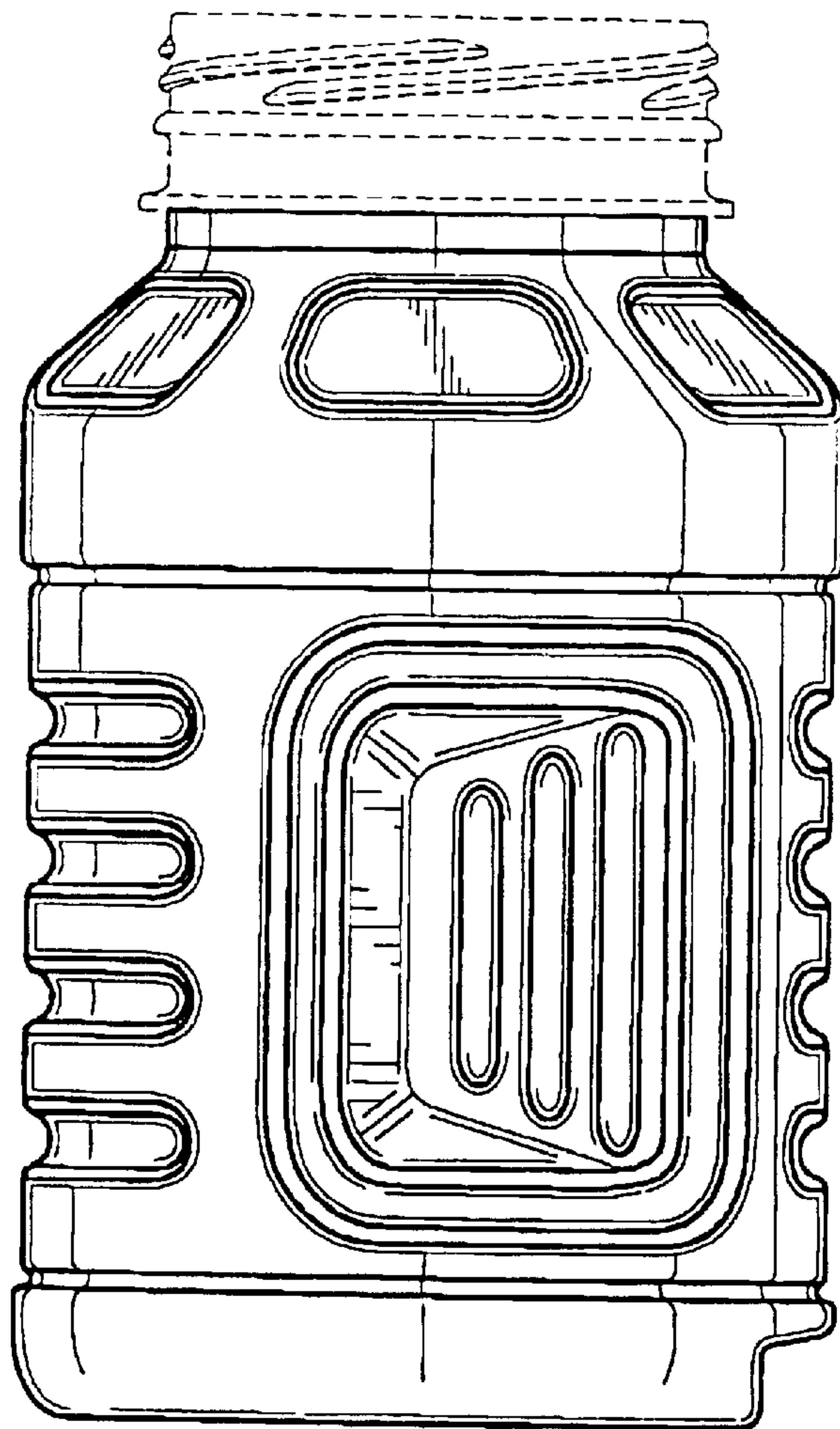

FIG. 6

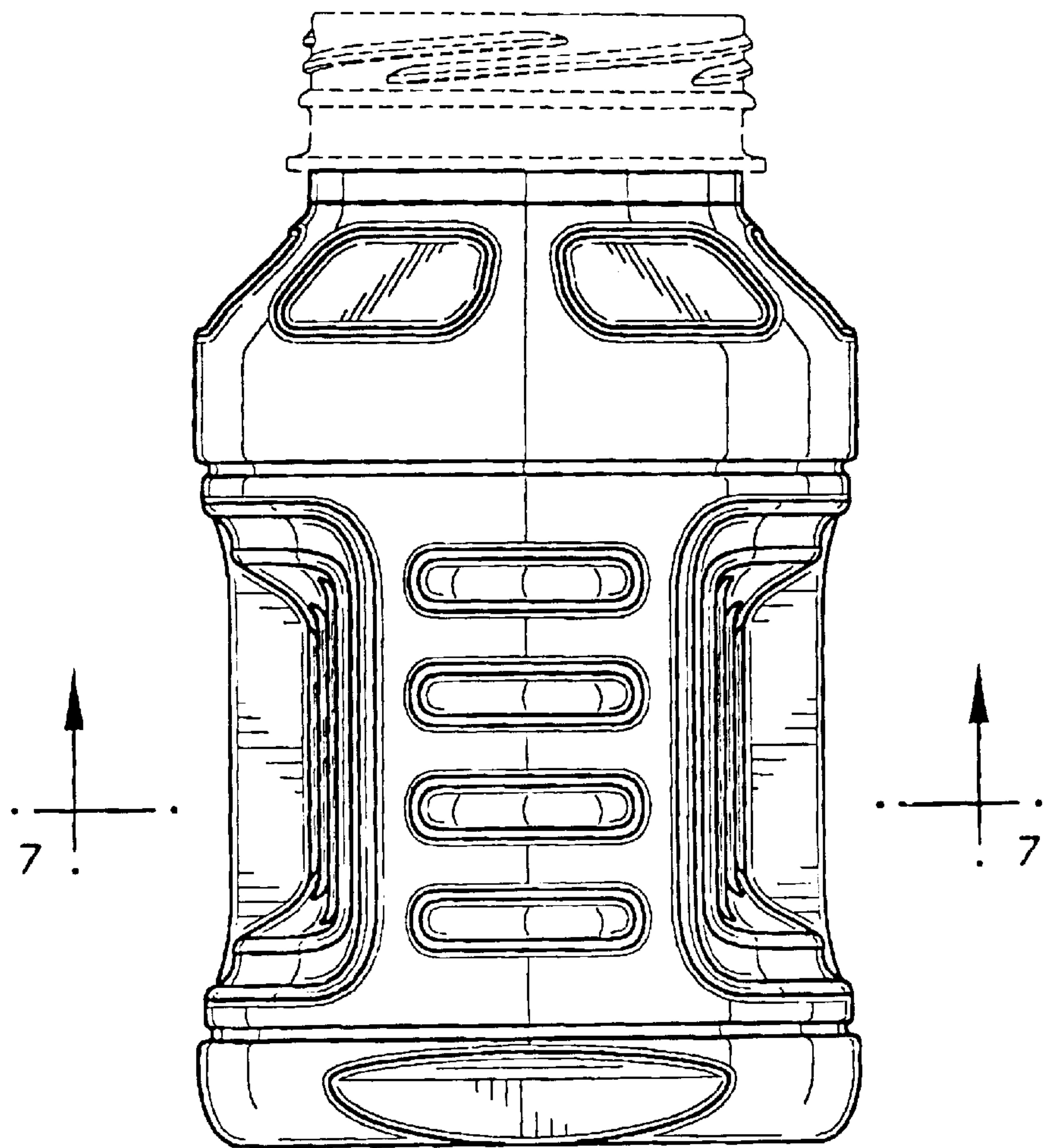

FIG. 7

