



US00D467577S

(12) **United States Design Patent**  
**Takagi**

(10) **Patent No.:** **US D467,577 S**

(45) **Date of Patent:** **\*\* Dec. 24, 2002**

(54) **DISC PLAYER**

(75) Inventor: **Noriaki Takagi**, Tokyo (JP)

(73) Assignee: **Sony Corporation**, Tokyo (JP)

(\*\*) Term: **14 Years**

(21) Appl. No.: **29/148,020**

(22) Filed: **Sep. 14, 2001**

(51) **LOC (7) Cl.** ..... **14-99**

(52) **U.S. Cl.** ..... **D14/217; D14/156**

(58) **Field of Search** ..... **D14/135-136,**  
**D14/156-157, 160-165, 167-168, 188,**  
**193-198; 369/75.1, 75.2, 77.1, 77.2**

(56) **References Cited**

**U.S. PATENT DOCUMENTS**

D329,231 S	*	9/1992	Lee	.....	D14/156
D376,800 S	*	12/1996	Shudo	.....	D14/156
D400,876 S		11/1998	Masamitsu		
D430,551 S		9/2000	Shiono		
D432,514 S		10/2000	Nakamura et al.		
D433,672 S		11/2000	Kobayashi		

**OTHER PUBLICATIONS**

Catalog "Planet Walkman", p. 12, Sony Corporation (Apr. 2000).

Catalog "Walkman", pp. 12, 13 & 14, Sony Corporation (Mar. 2001).

Home Page "Portable CD Player, SL-CT640, SL-CT440", 3 pgs., Panasonic Corporation (Jun. 2001 at the latest).

\* cited by examiner

*Primary Examiner*—Nanda Bondade

(74) *Attorney, Agent, or Firm*—Rader, Fishman & Grauer PLLC

(57) **CLAIM**

The ornamental design for a disc player, as shown and described.

**DESCRIPTION**

FIG. 1 is a perspective view of a disc player showing my new design;

FIG. 2 is a front elevational view thereof;

FIG. 3 is a left side elevational view thereof;

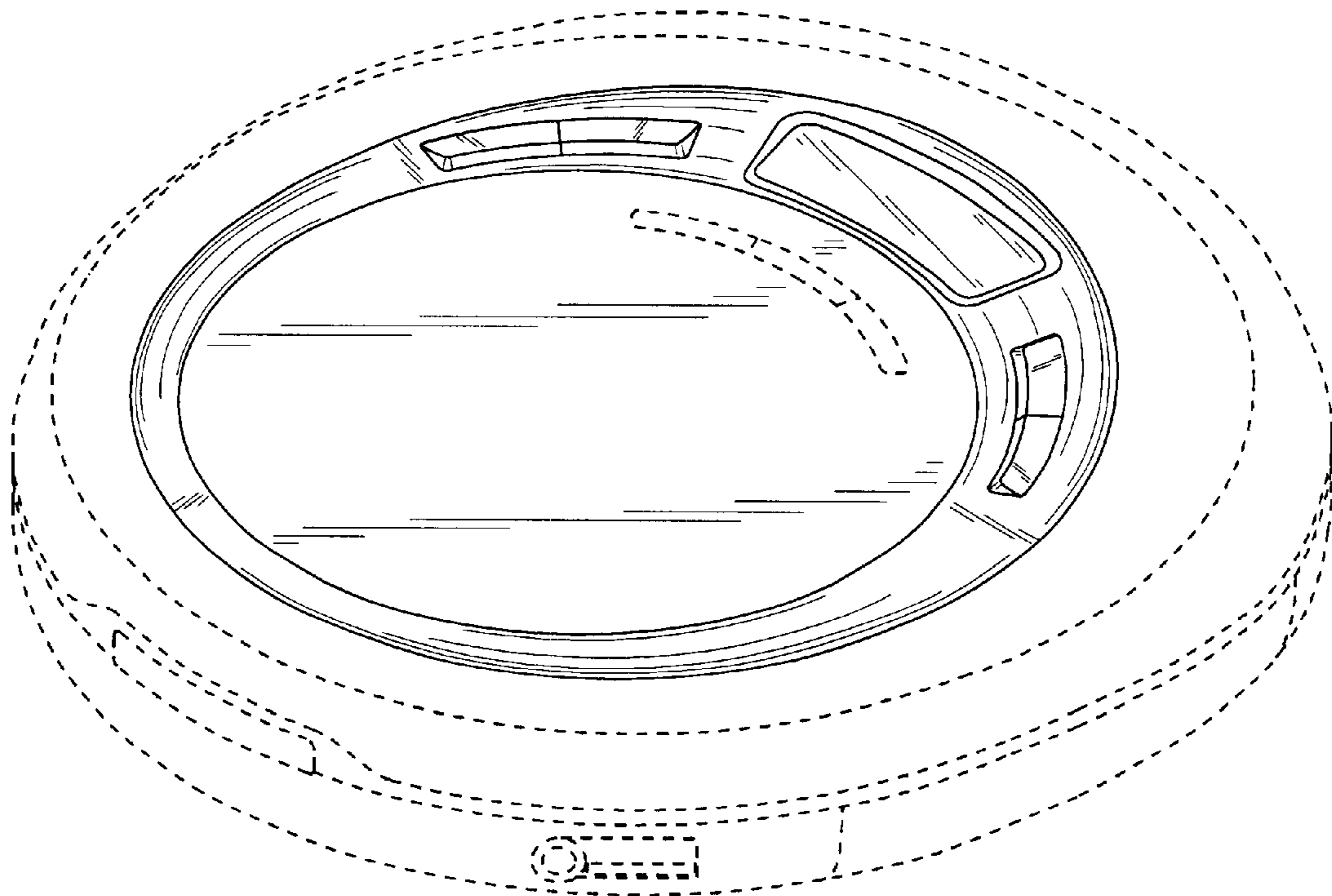
FIG. 4 is a right side elevational view thereof;

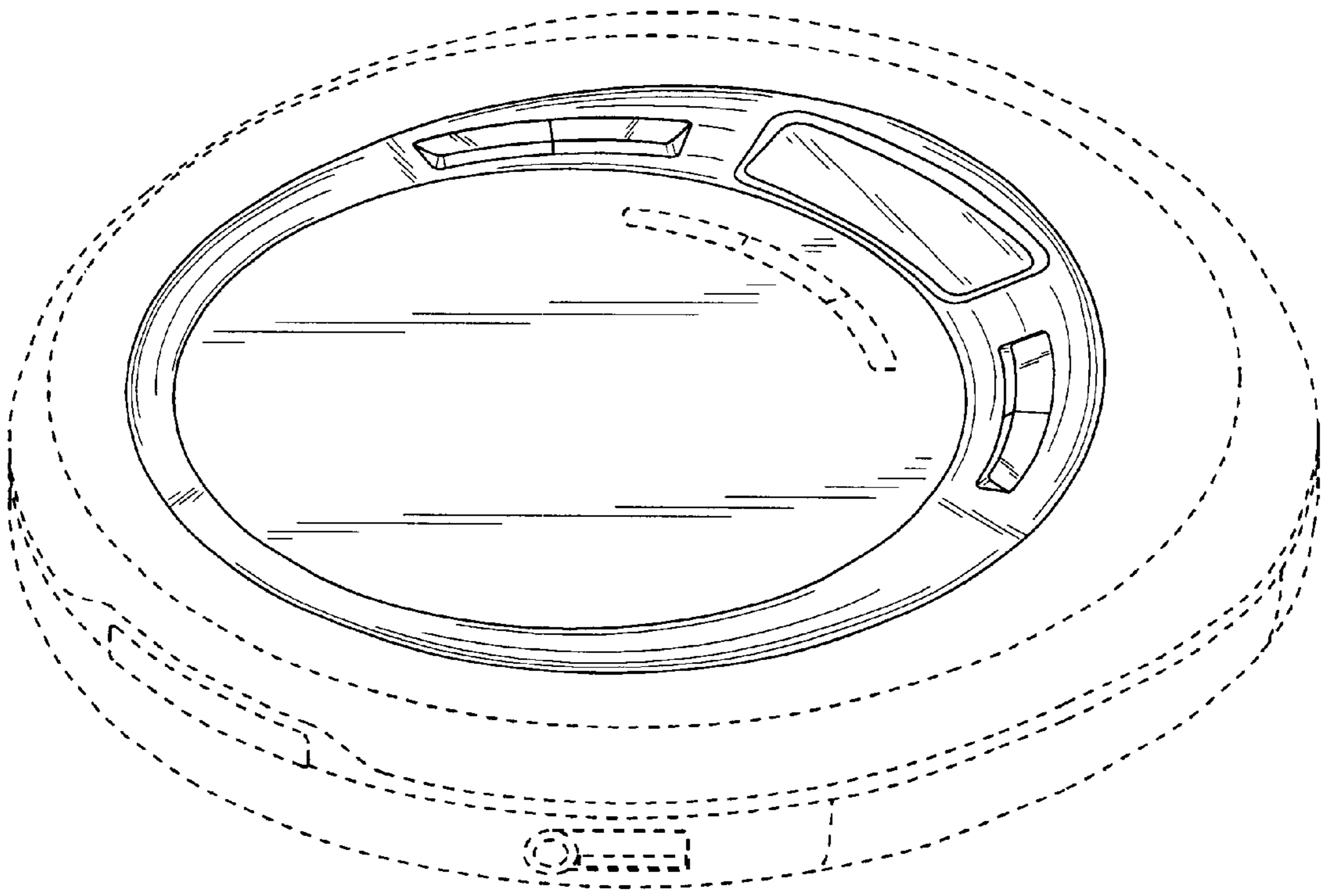
FIG. 5 is a top plan view thereof; and,

FIG. 6 is a bottom plan view thereof.

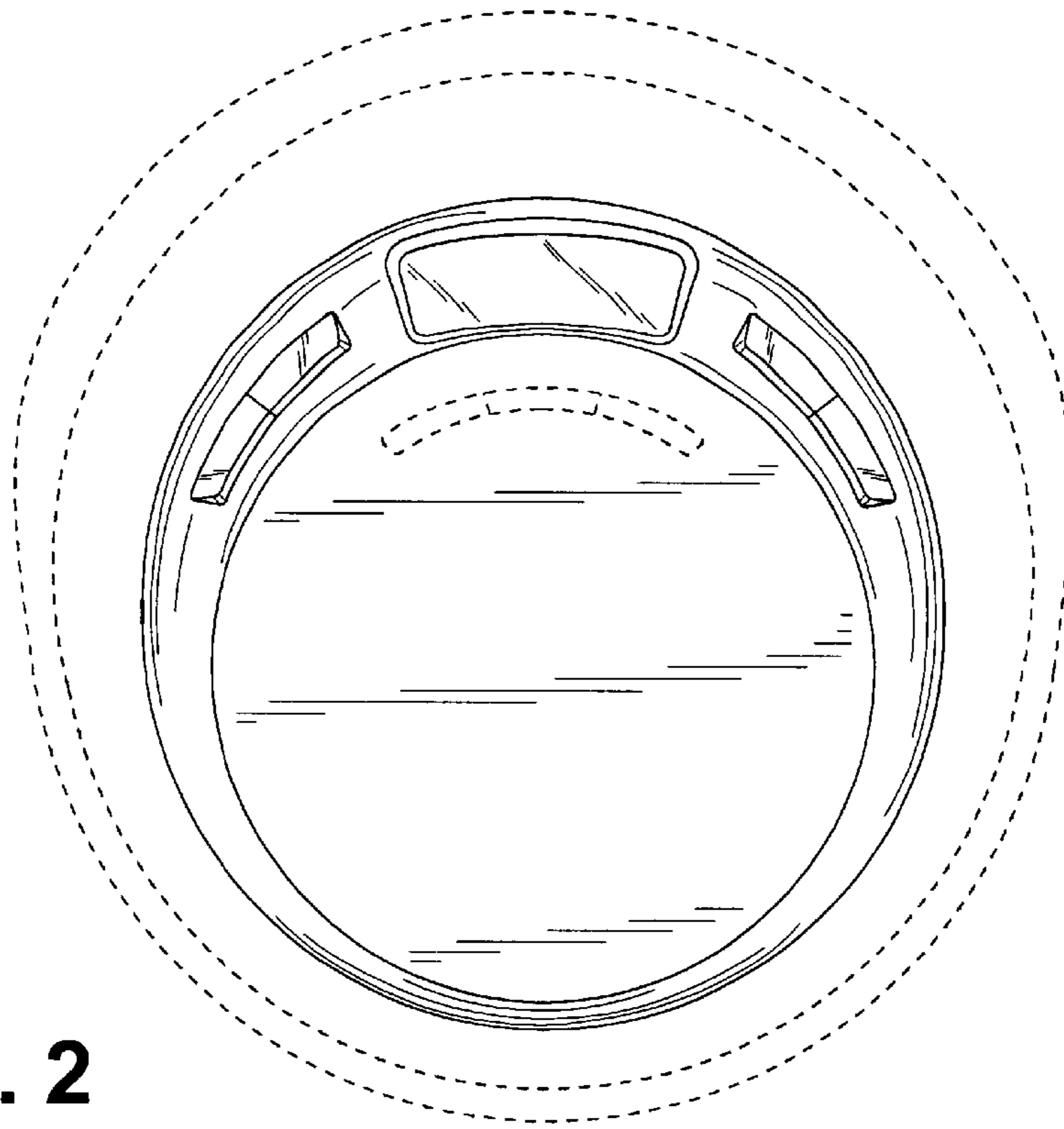
Portions in broken lines are for illustrative purposes only and form no part of the claimed design.

**1 Claim, 3 Drawing Sheets**

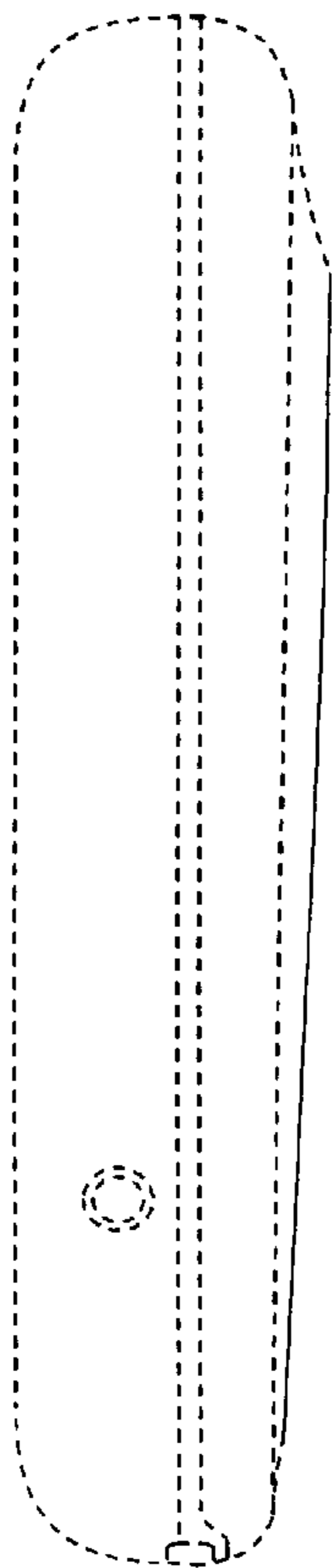




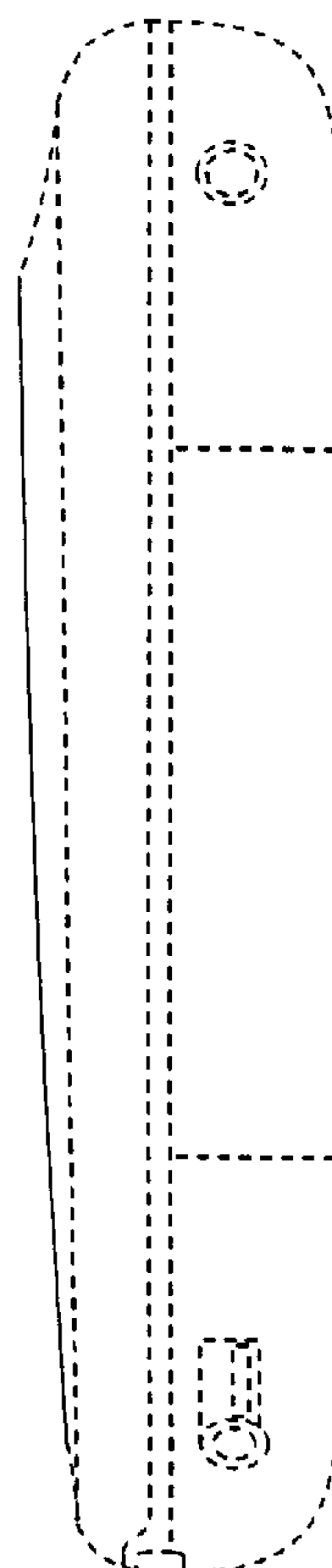
**Fig. 1**



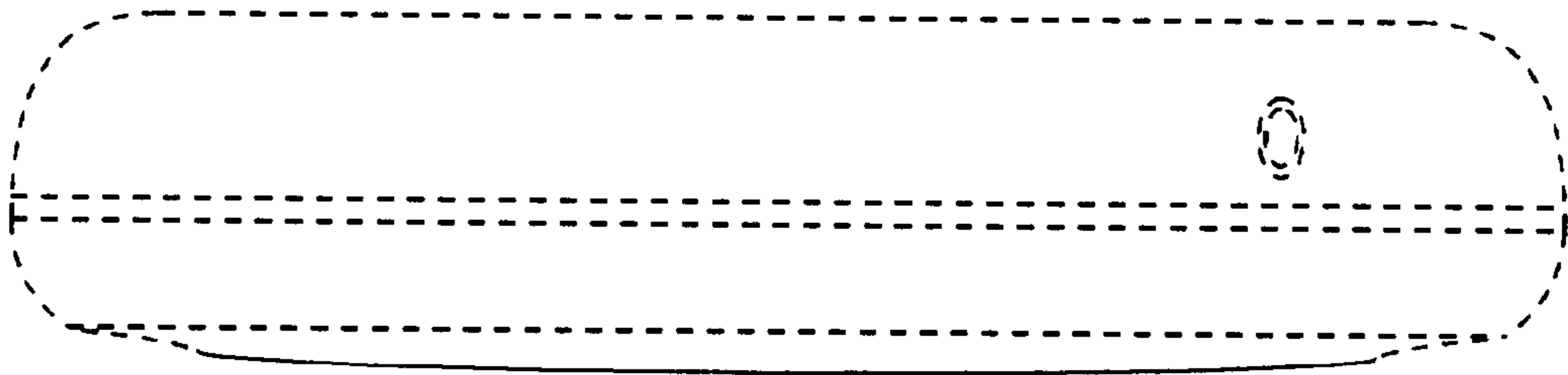
**Fig. 2**



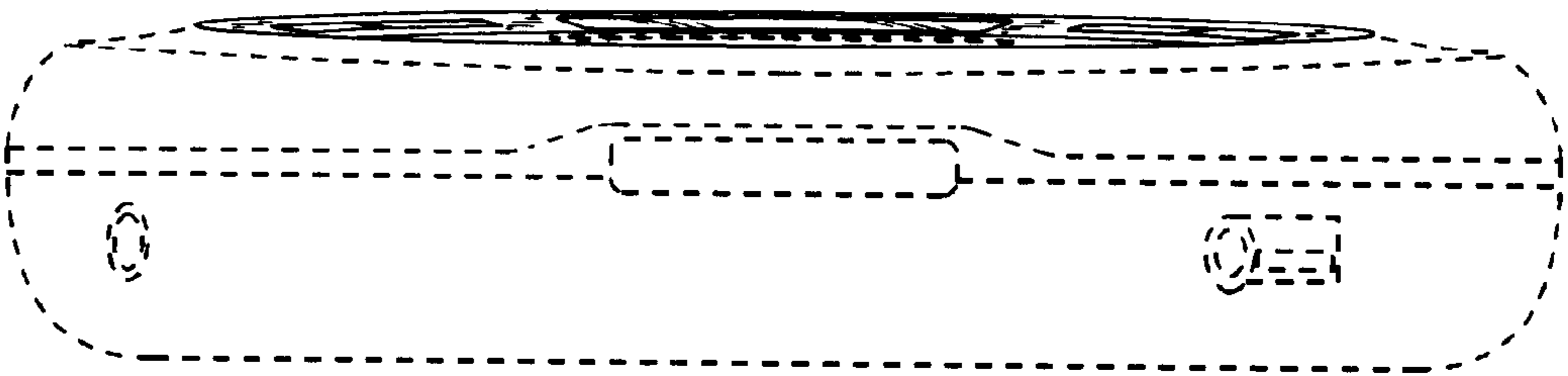
**Fig. 3**



**Fig. 4**



**Fig. 5**



**Fig. 6**