



US00D467511S

(12) **United States Design Patent**
Kitamura et al.

(10) **Patent No.:** **US D467,511 S**

(45) **Date of Patent:** **** Dec. 24, 2002**

(54) **MODULE FOR LOCATING SYSTEM**

(75) Inventors: **Takaaki Kitamura**, Tokyo (JP);
Koichiro Teranishi, Tokyo (JP); **Tadao Ogaki**, Tokyo (JP); **Masato Hayashida**, Tokyo (JP); **Masami Amagasu**, Tokyo (JP)

(73) Assignee: **Sony Corporation**, Tokyo (JP)

(**) Term: **14 Years**

(21) Appl. No.: **29/149,942**

(22) Filed: **Oct. 24, 2001**

(51) **LOC (7) Cl.** **10-04**

(52) **U.S. Cl.** **D10/65**

(58) **Field of Search** D10/65; 340/988,
340/539; 342/419, 357, 439, 457; 348/515;
345/441; 463/46; 701/200, 300, 215, 35

(56) **References Cited**

U.S. PATENT DOCUMENTS

D421,597 S	3/2000	Oba et al.	
D421,967 S	3/2000	Oba et al.	
D427,159 S	6/2000	Oba et al.	
D429,170 S	* 8/2000	Maquaire	D10/65
D432,505 S	10/2000	Oba et al.	
D456,289 S	* 4/2002	Laverick	D10/65

OTHER PUBLICATIONS

Webpage "News and Information 'PEG-T400, PEG-T600C'", <http://www.sony.jp/CorporateCruise/Press/200111/01-1119>, 5 sheets, SONY (Nov. 2001).

* cited by examiner

Primary Examiner—Antoine Duval Davis

(74) *Attorney, Agent, or Firm*—Rader, Fishman & Grauer PLLC

(57) **CLAIM**

The ornamental design for a module for locating system, as shown and described.

DESCRIPTION

FIG. 1 is a perspective view of a module for locating system showing our new design;
FIG. 2 is a front elevational view thereof;
FIG. 3 is a rear elevational view thereof;
FIG. 4 is a left side elevational view thereof;
FIG. 5 is a right side elevational view thereof;
FIG. 6 is a top plan view thereof; and
FIG. 7 is a bottom plan view thereof.
FIG. 8 is a second embodiment perspective view of a module for locating system showing our new design;
FIG. 9 is a front elevational view thereof;
FIG. 10 is a rear elevational view thereof;
FIG. 11 is a left side elevational view thereof;
FIG. 12 is a right side elevational view thereof;
FIG. 13 is a top plan view thereof; and
FIG. 14 is a bottom plan view thereof.

1 Claim, 8 Drawing Sheets

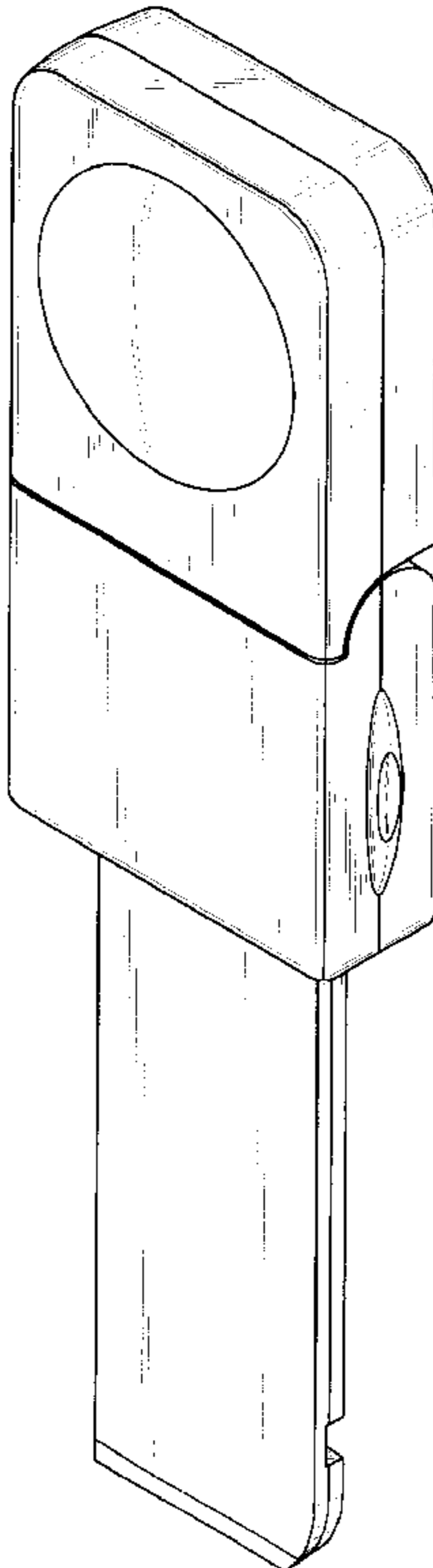

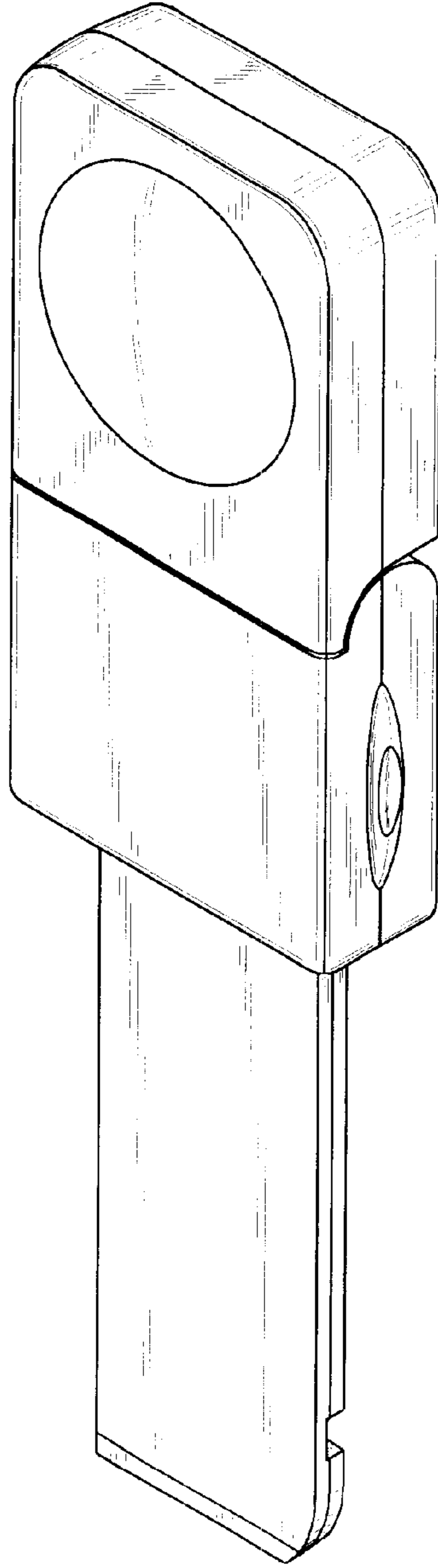

Fig. 1

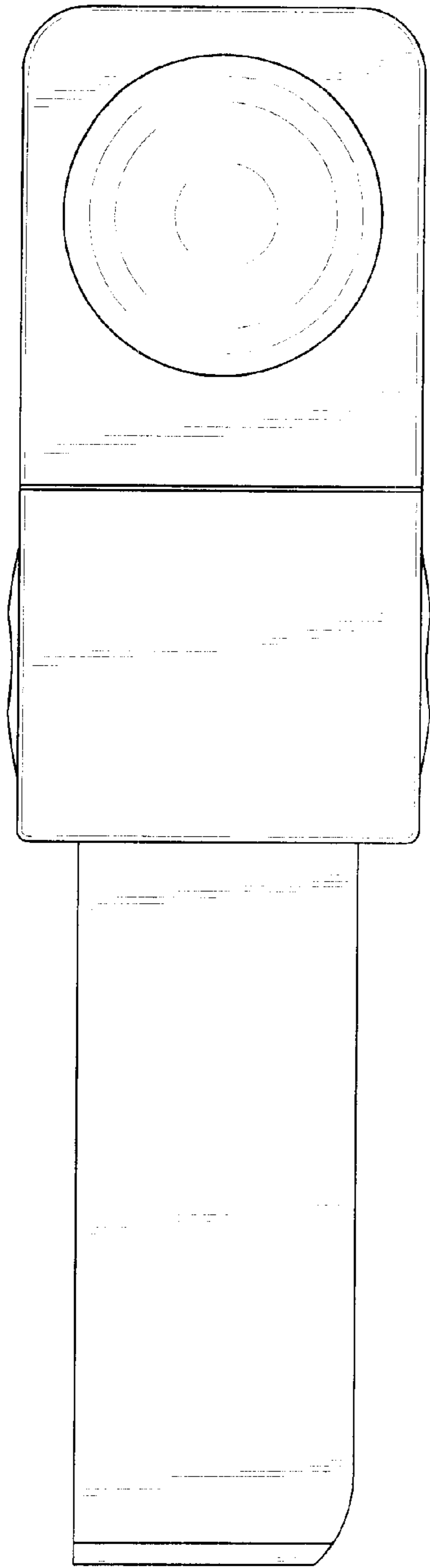

Fig. 2

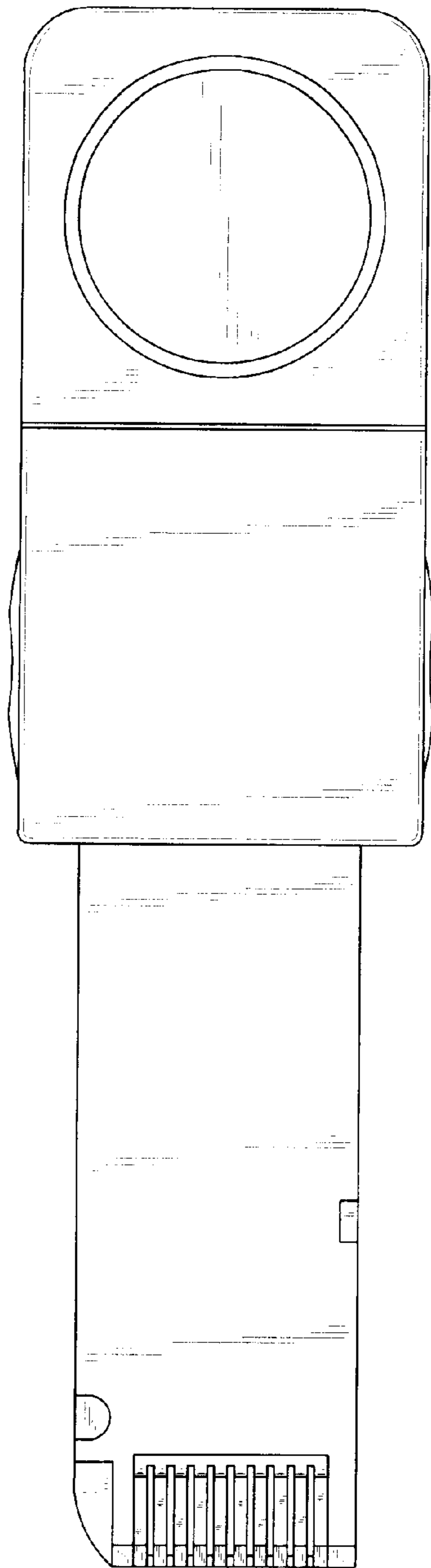

Fig. 3

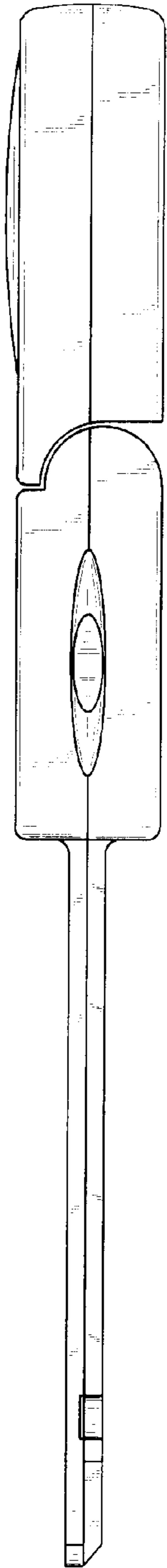

Fig. 4

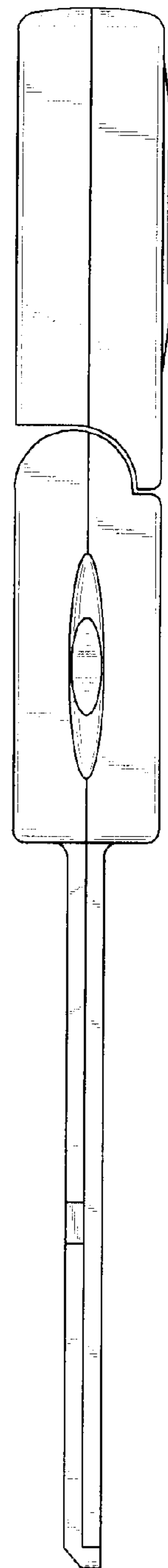

Fig. 5

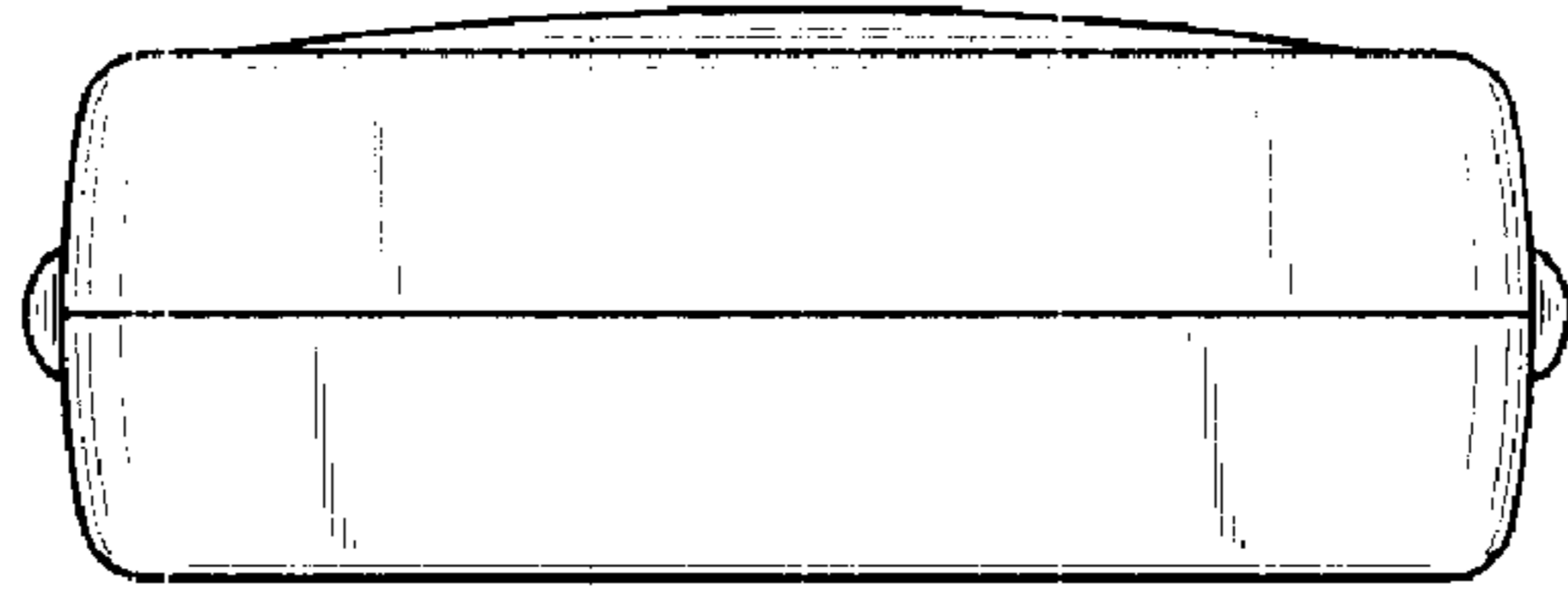

Fig. 6

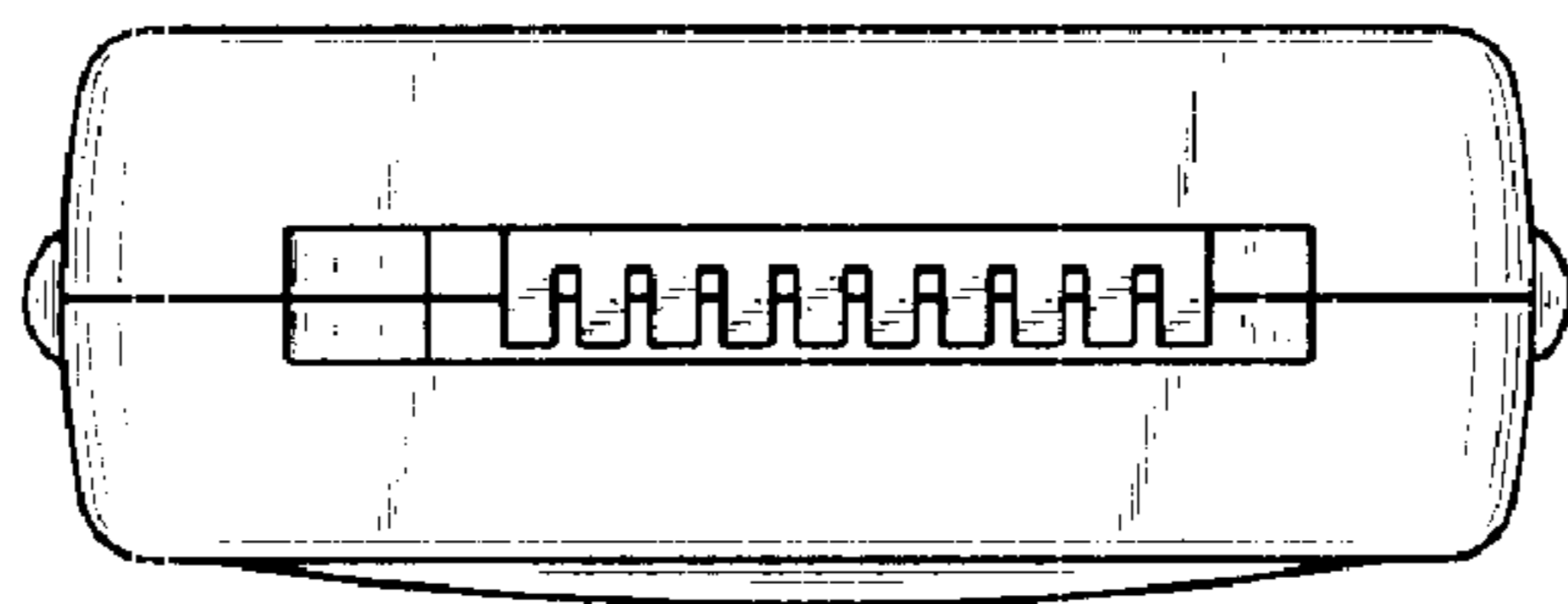

Fig. 7

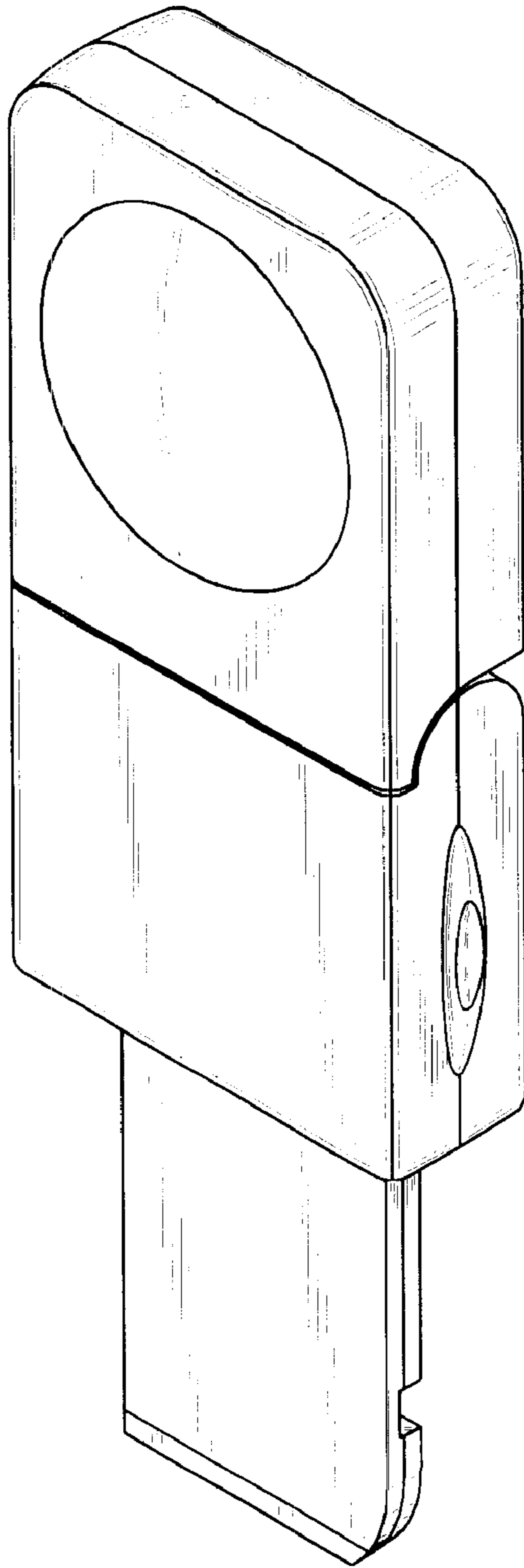

Fig. 8

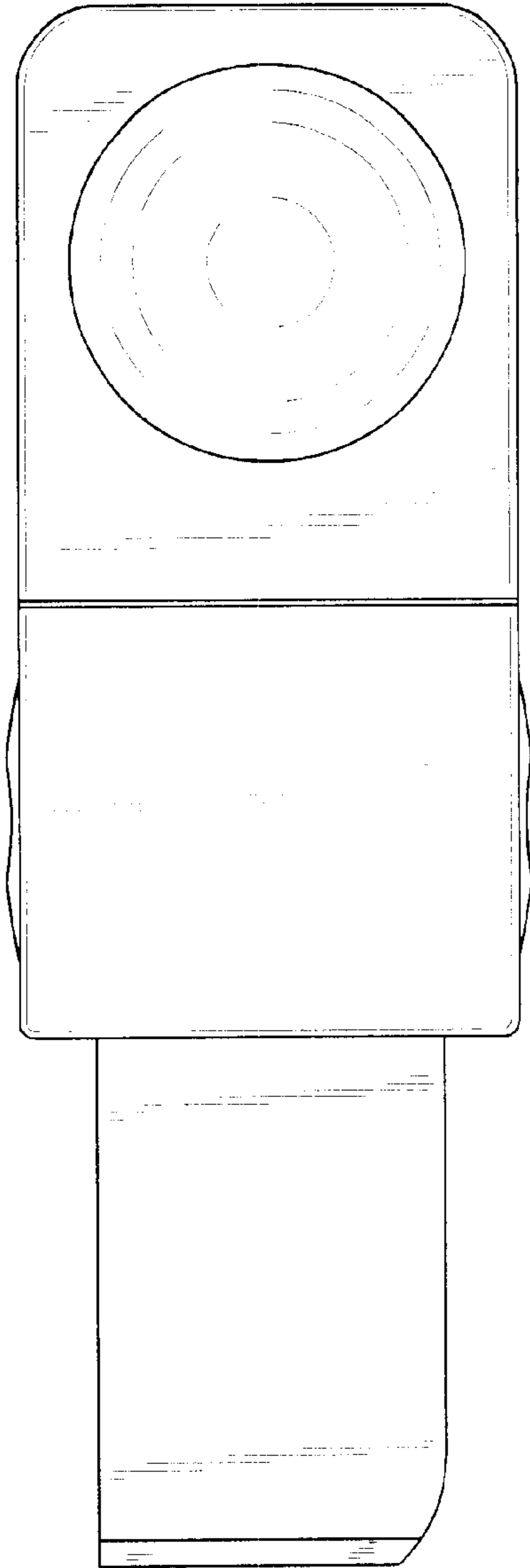

Fig. 9

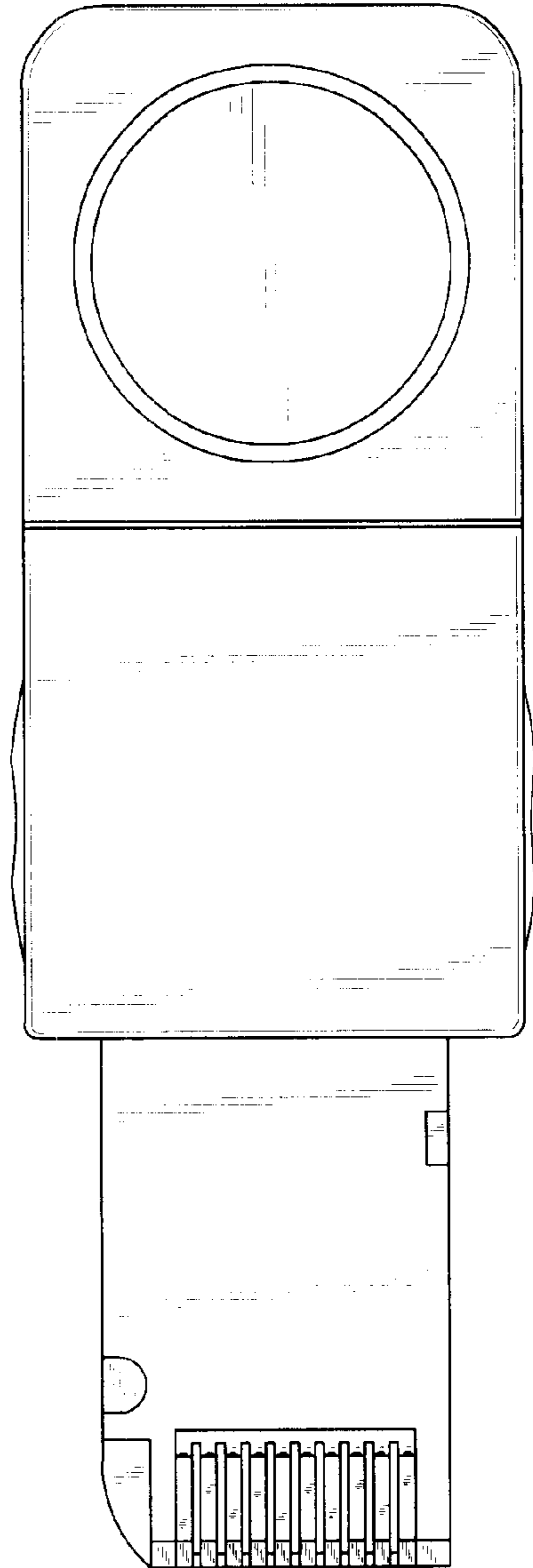

Fig. 10

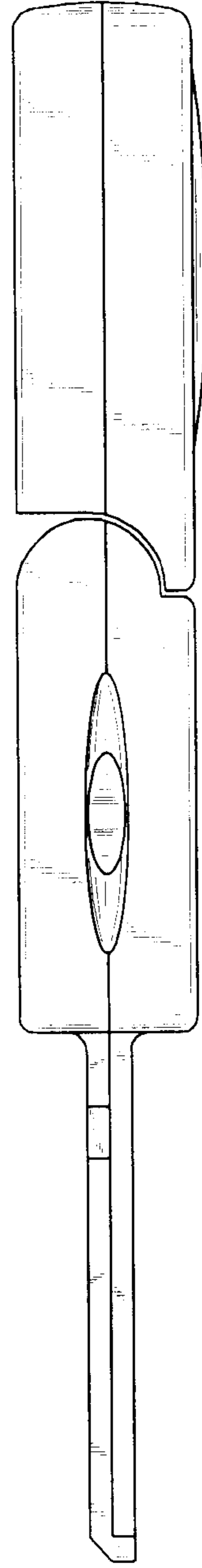
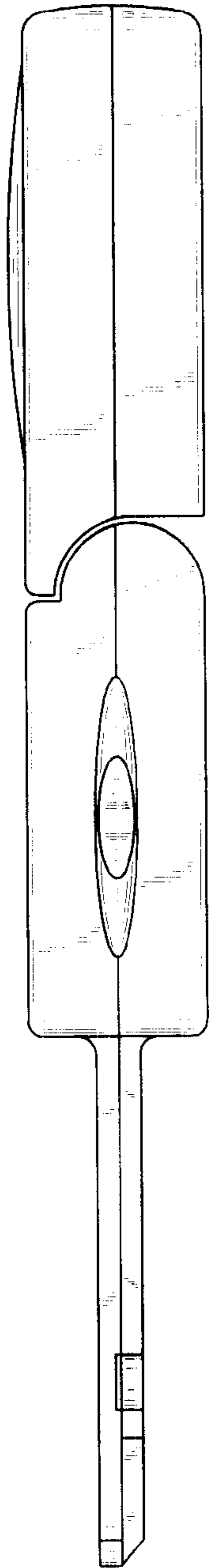

Fig. 11

Fig. 12

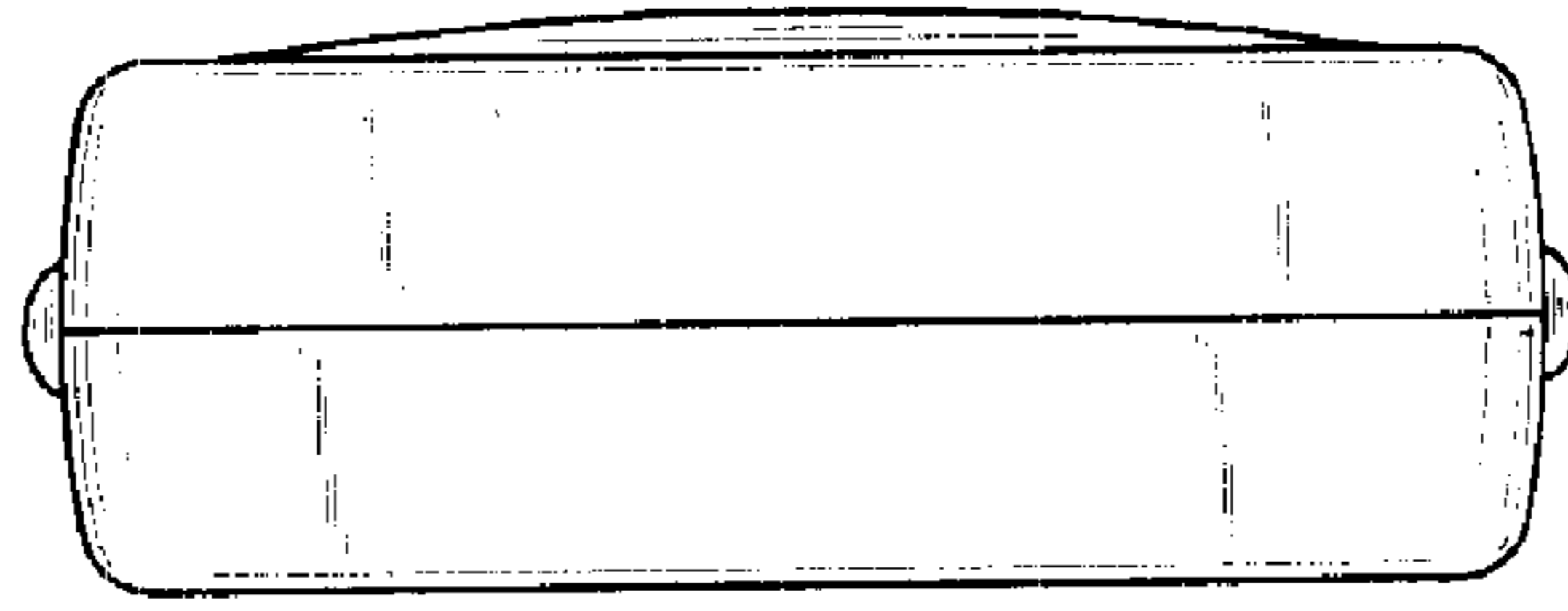

Fig. 13

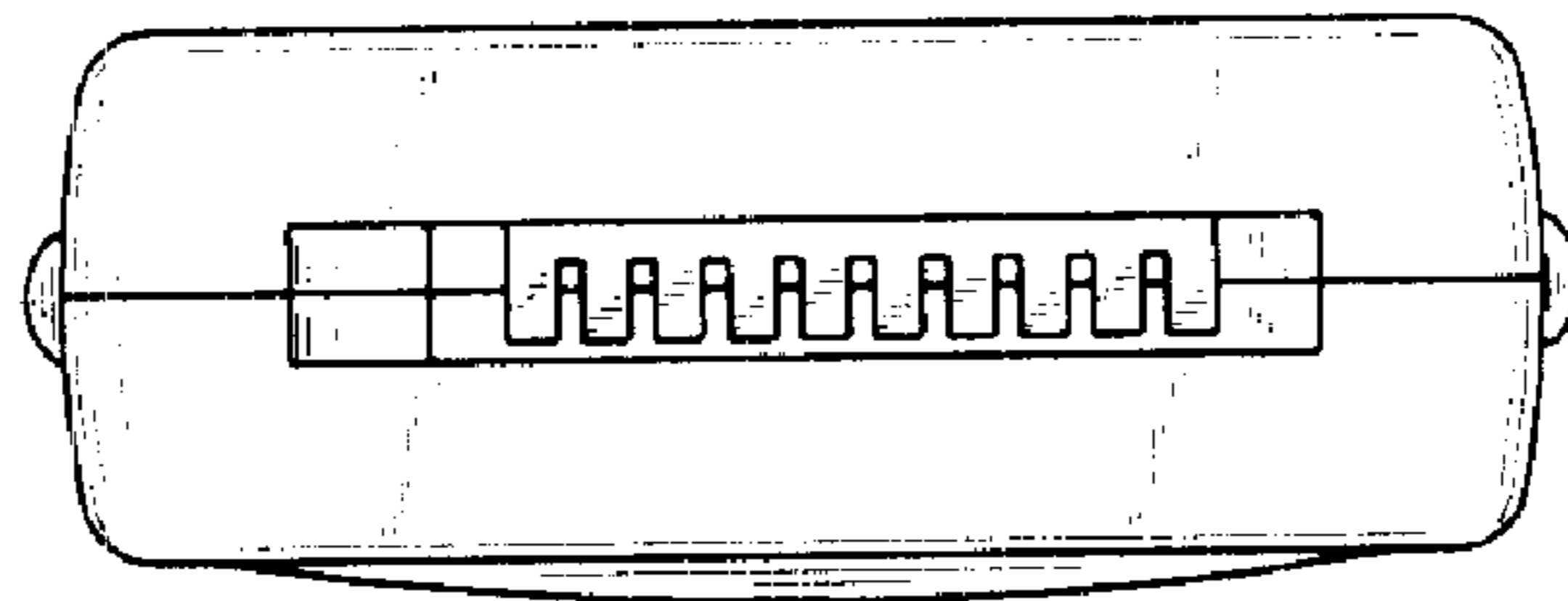

Fig. 14