



US00D467498S

(12) **United States Design Patent**
Taylor

(10) **Patent No.:** **US D467,498 S**

(45) **Date of Patent:** **** Dec. 24, 2002**

(54) **HAND PROTECTOR**

(76) Inventor: **Ronnie A. Taylor**, 120 Walker Pkwy.,
Fayetteville, GA (US) 30214

(**) Term: **14 Years**

(21) Appl. No.: **29/149,064**

(22) Filed: **Oct. 3, 2001**

(51) **LOC (7) Cl.** **09-07**

(52) **U.S. Cl.** **D9/434; D9/455**

(58) **Field of Search** D9/434, 455; D29/113,
D29/114; 294/137, 171

(56) **References Cited**

U.S. PATENT DOCUMENTS

736,632	A	*	8/1903	Priddat	294/171
967,531	A	*	8/1910	Leuschner	284/171
D91,748	S	*	3/1934	Zessau	D9/434
2,448,894	A	*	9/1948	Laus	294/171
4,823,433	A	*	4/1989	Curtis	294/171 X
4,890,355	A	*	1/1990	Schulten	294/171 X
D325,156	S	*	4/1992	Sweeny	D9/434
D327,846	S	*	7/1992	Jacobs	D9/434
D329,973	S	*	10/1992	Schuttinga	D9/434
D362,181	S	*	9/1995	Meyers et al.	D9/434

* cited by examiner

Primary Examiner—Dominic Simone

(74) *Attorney, Agent, or Firm*—Harry I. Leon

(57) **CLAIM**

The ornamental design for a hand protector, as shown and described.

DESCRIPTION

FIG. 1 is a top, right side perspective view of a hand protector, the broken-line disclosure of bag and a person's hand using the hand protector is being shown for illustrative purposes only and forming no part of the claimed design;

FIG. 2 is a top plan view of on of the hand protector according to FIG. 1;

FIG. 3 is a bottom plan view of the hand protector according to FIG. 1;

FIG. 4 is a right side elevational view of the hand protector according to FIG. 1;

FIG. 5 is a left side elevational view of the hand protector according to FIG. 1;

FIG. 6 is a front elevational view of the hand protector according to FIG. 1; and,

FIG. 7 is a rear elevational view of the hand protector according to FIG. 1.

1 Claim, 3 Drawing Sheets

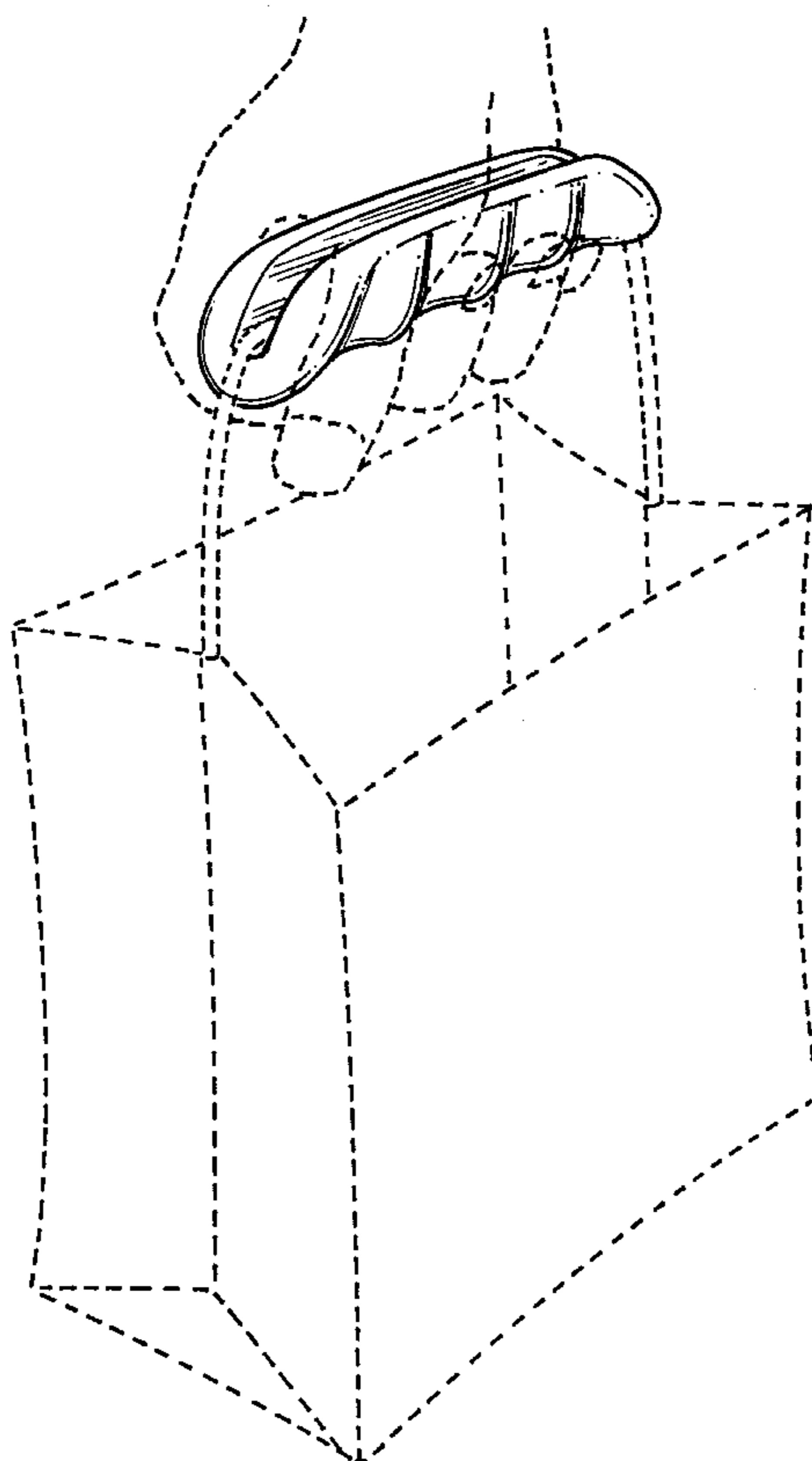

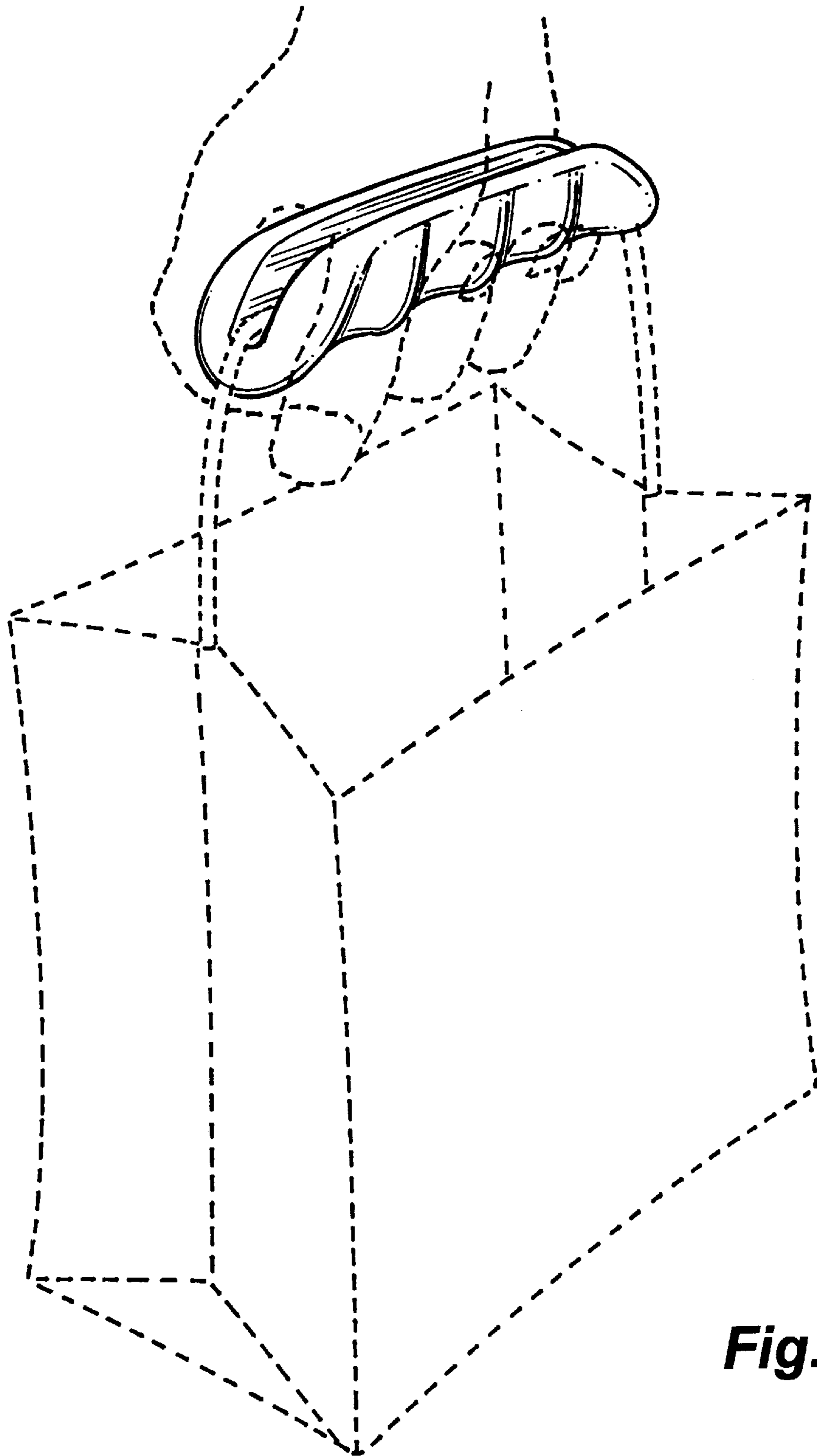

Fig. 1

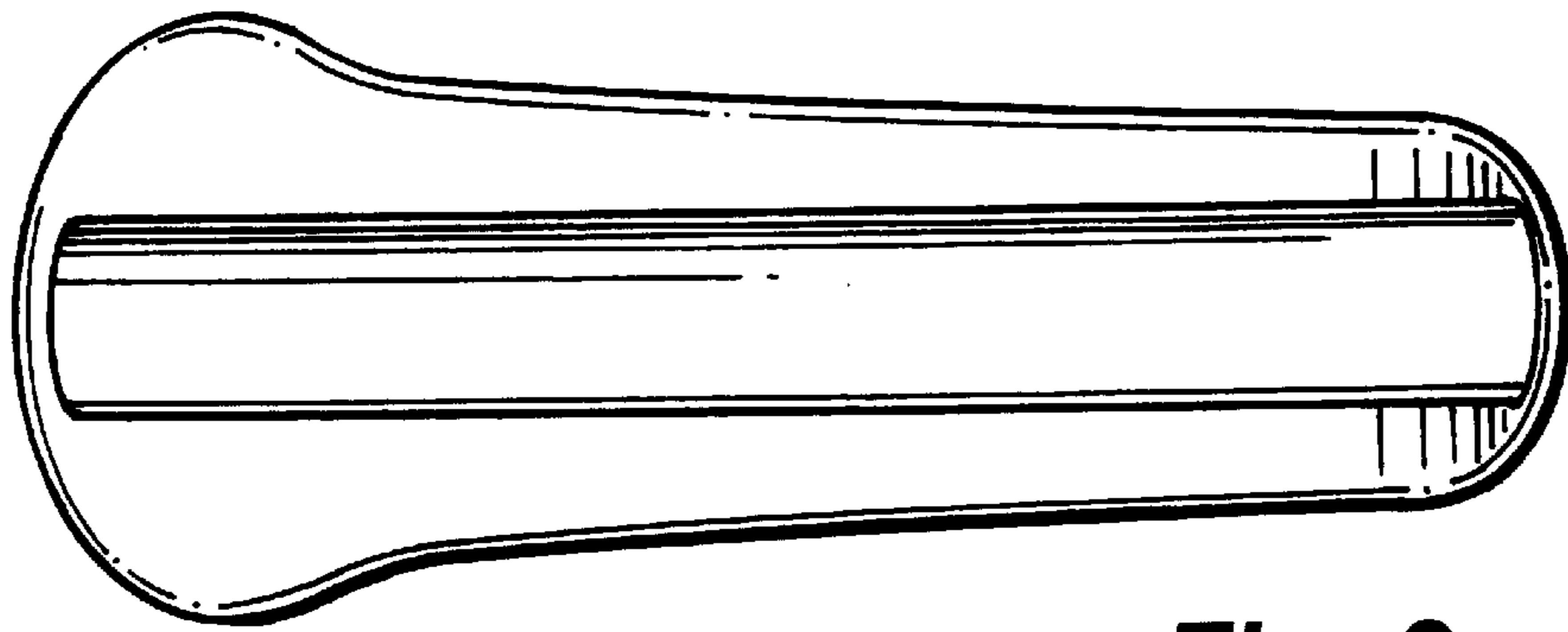

Fig. 2

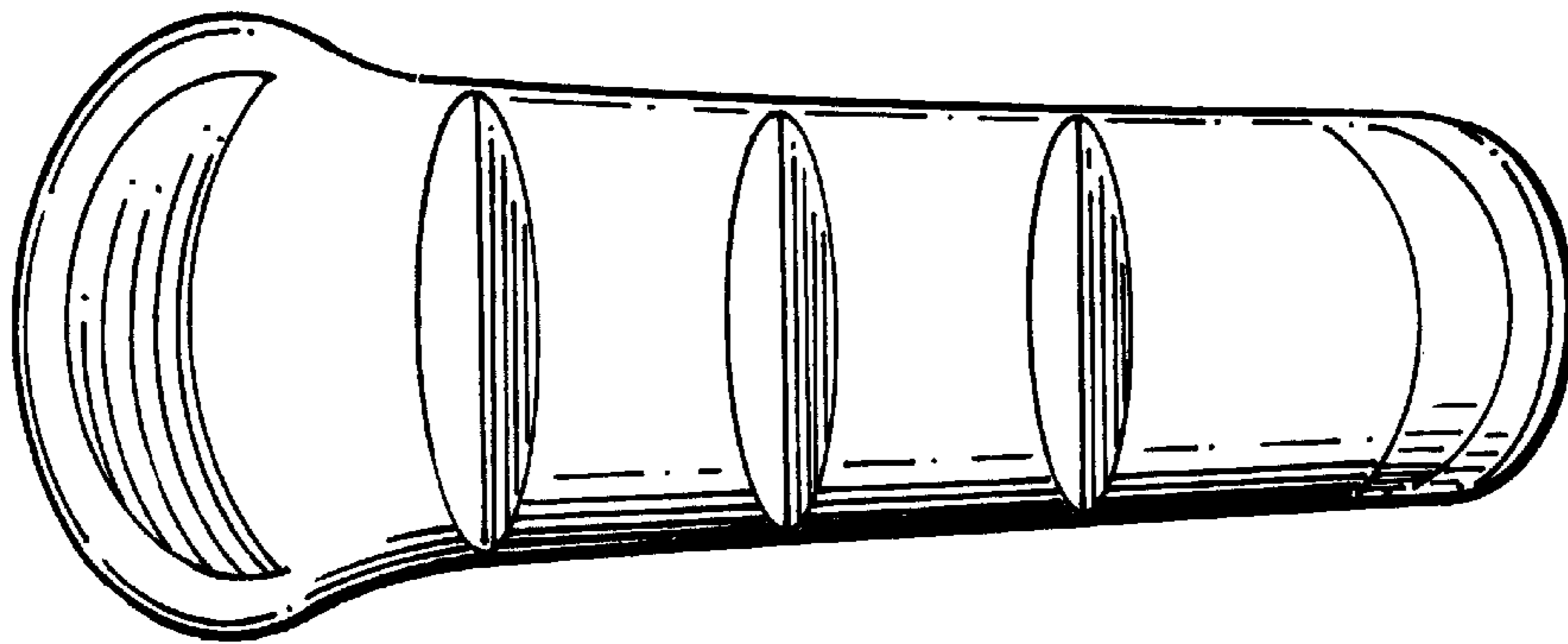

Fig. 3

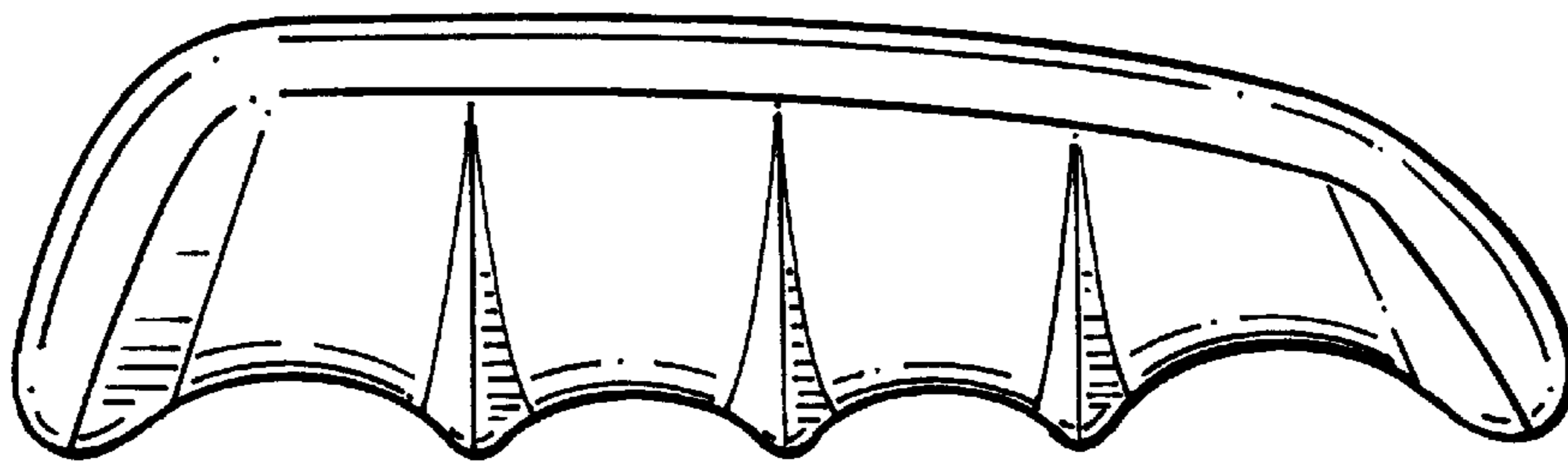

Fig. 4

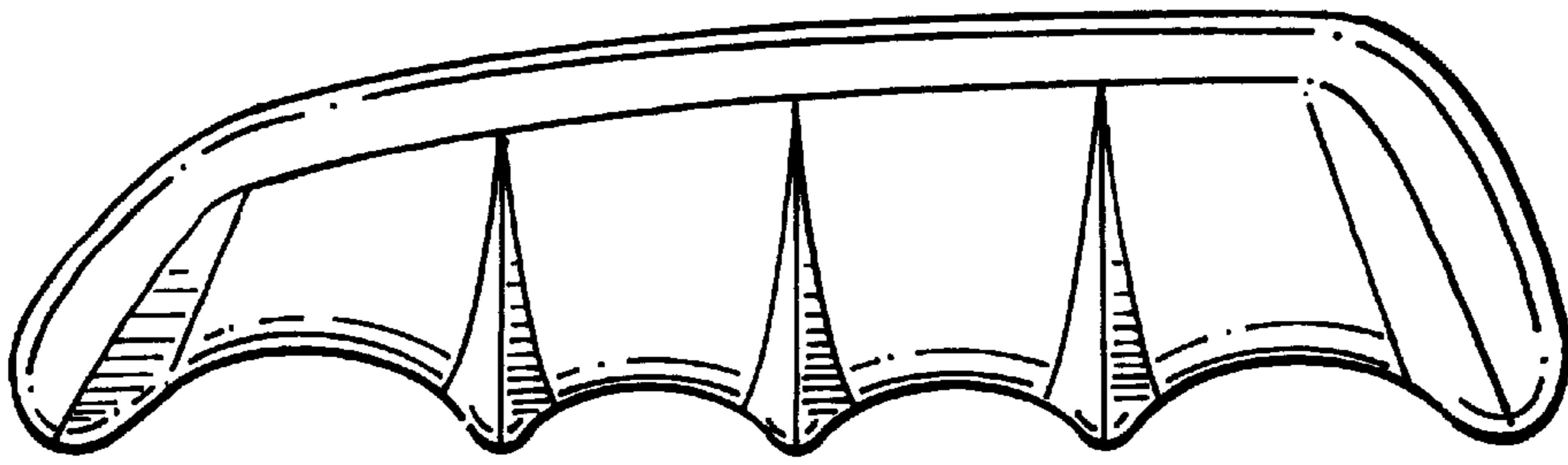

Fig. 5

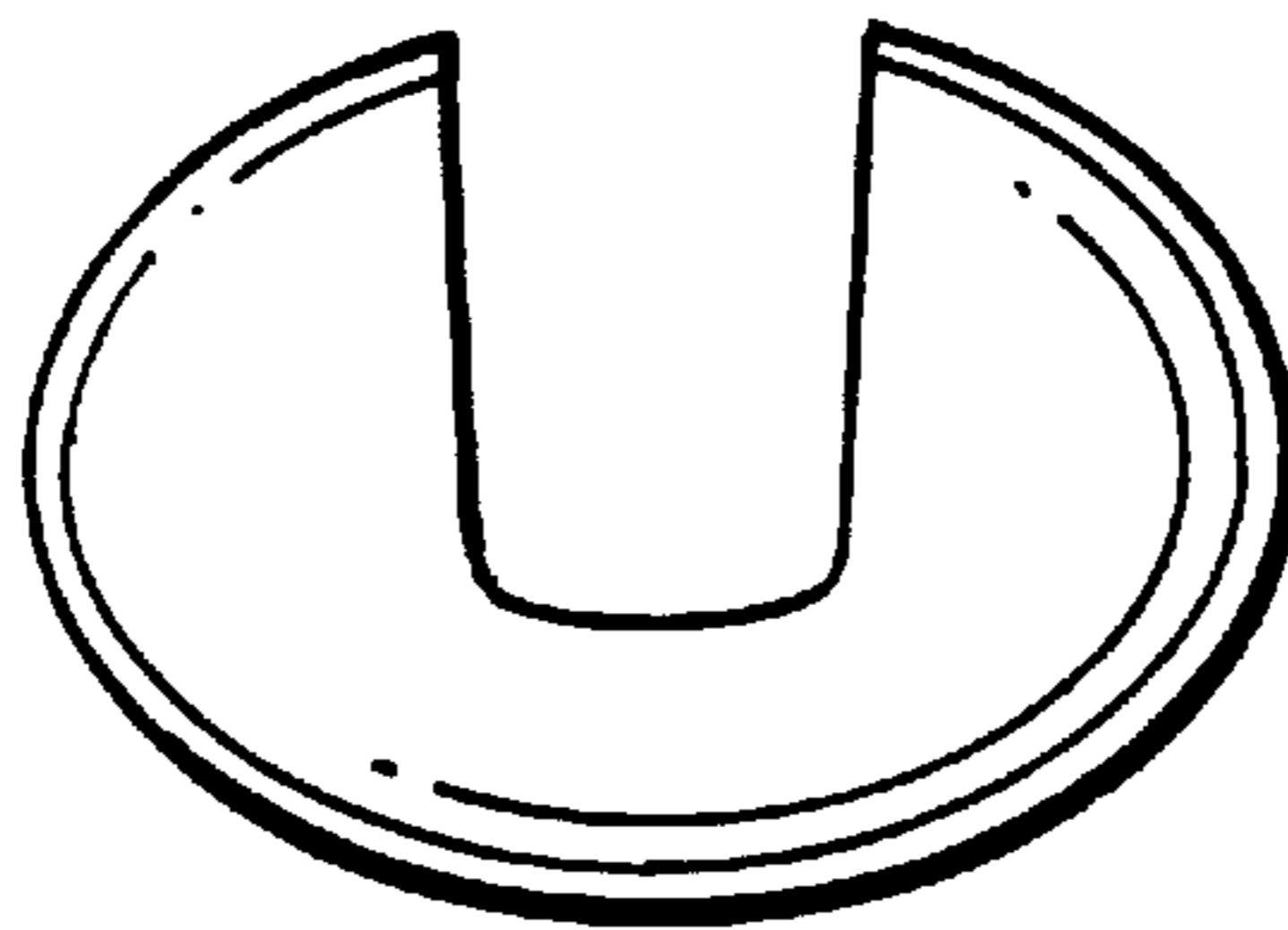

Fig. 6

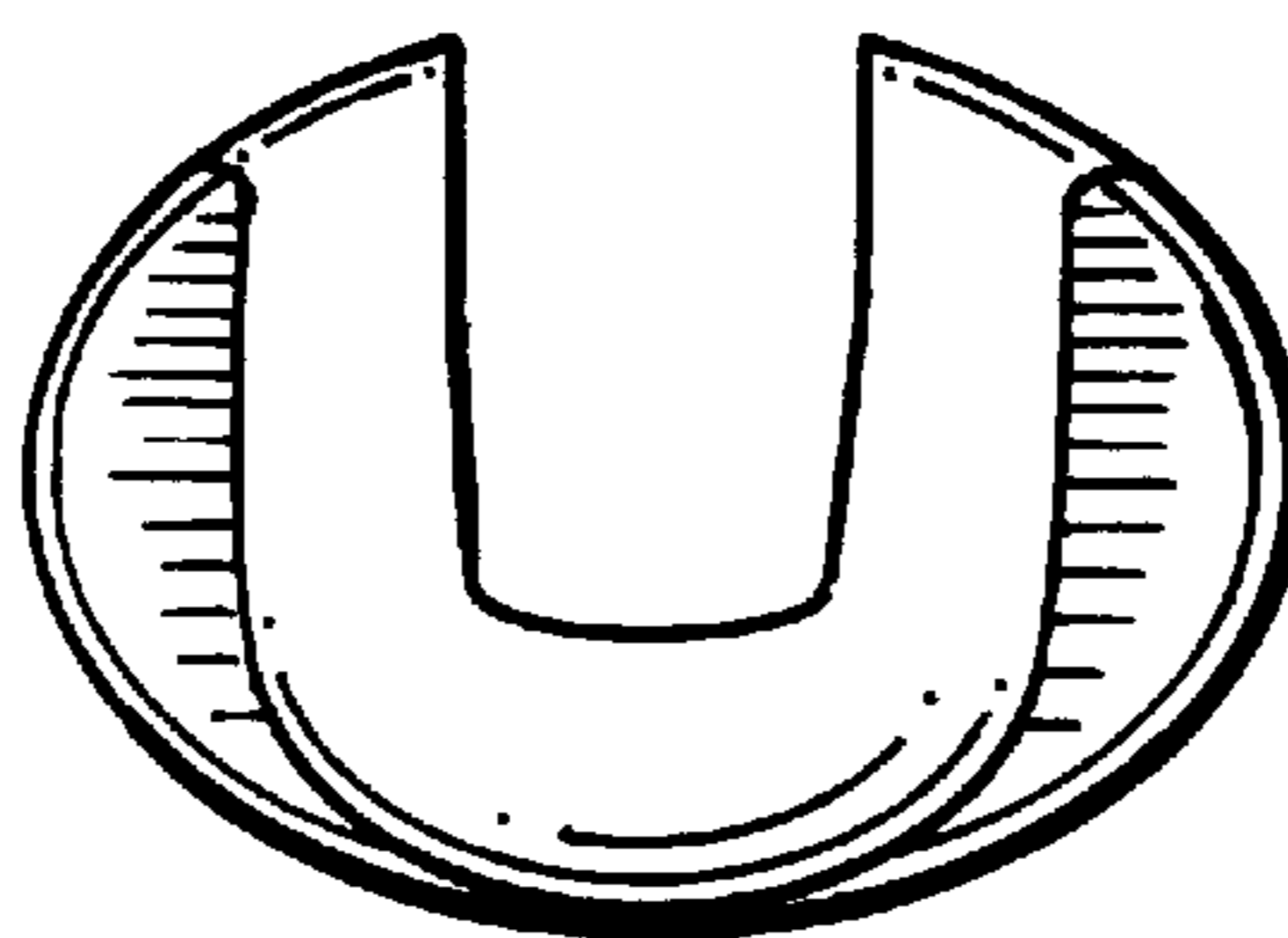

Fig. 7