



US00D467496S

(12) **United States Design Patent**
Hayes et al.

(10) **Patent No.:** **US D467,496 S**

(45) **Date of Patent:** **** Dec. 24, 2002**

(54) **SMOOTHWALL HINGED CONTAINER**

(75) Inventors: **Thomas J. Hayes**, McHenry, IL (US);
Brian J. Cammarata, Farmington, NY (US);
William Loiselle, Lindenhurst, IL (US)

(73) Assignee: **Pactiv Corporation**, Lake Forest, IL (US)

(**) Term: **14 Years**

(21) Appl. No.: **29/148,104**

(22) Filed: **Sep. 14, 2001**

(51) **LOC (7) Cl.** **09-03**

(52) **U.S. Cl.** **D9/425**

(58) **Field of Search** D9/414, 420-426,
D9/432, 337; D7/629, 601; 206/508, 518,
216, 541, 521, 523; 220/556, 315, 780,
793, 4.21-4.27, 790, 791, 801, 805, 259,
263, 836, 837; 229/406, 407, 902, 938;
426/107, 109, 113, 120

(56) **References Cited**

U.S. PATENT DOCUMENTS

3,253,762 A	*	5/1966	Gaunt	426/106
3,613,938 A		10/1971	Westcott	220/44 R
4,390,113 A		6/1983	Bird	220/306
D276,216 S		11/1984	Michaud	D9/425
4,664,281 A	*	5/1987	Falk et al.	220/3.8
4,704,510 A		11/1987	Matsui	219/10.55 E
4,771,934 A		9/1988	Kalmanides	229/2.5 R
4,859,822 A		8/1989	Ragusa et al.	219/10.55 E
4,974,738 A	*	12/1990	Kidd et al.	229/406
D315,100 S		3/1991	Sheehan	D9/427
D339,744 S	*	9/1993	Seppala	D9/425
D343,576 S	*	1/1994	Krupa	D9/423
D348,608 S	*	7/1994	Wyslotsky	D9/425
5,339,973 A		8/1994	Edwards et al.	220/4.23
5,423,453 A		6/1995	Fritz	220/608
D361,035 S		8/1995	Krupa	D9/424

(List continued on next page.)

Primary Examiner—Prabhakar Deshmukh
(74) *Attorney, Agent, or Firm*—Jenkins & Gilchrist

(57) **CLAIM**

The ornamental design for “smoothwall hinged container”, substantially as shown and described.

DESCRIPTION

FIG. 1 is a perspective view of a smoothwall hinged container according to one embodiment of the present invention.

FIG. 2 is a top view of the smoothwall hinged container according to the embodiment shown in FIG. 1.

FIG. 3 is a bottom view of the smoothwall hinged container according to the embodiment shown in FIG. 1.

FIG. 4 is a front view of the smoothwall hinged container according to the embodiment shown in FIG. 1.

FIG. 5 is an end view of the smoothwall hinged container according to the embodiment shown in FIG. 1.

FIG. 6 is a right side view of the smoothwall hinged container according to the embodiment shown in FIG. 1.

FIG. 7 is a left side view of the smoothwall hinged container according to the embodiment shown in FIG. 1.

FIG. 8 is a perspective view of a smoothwall hinged container according to another embodiment of the present invention.

FIG. 9 is a top view of the smoothwall hinged container according to the embodiment shown in FIG. 8.

FIG. 10 is a bottom view of the smoothwall hinged container according to the embodiment shown in FIG. 8.

FIG. 11 is a front view of the smoothwall hinged container according to the embodiment shown in FIG. 8.

FIG. 12 is an end view of the smoothwall hinged container according to the embodiment shown in FIG. 8.

FIG. 13 is a right side view of the smoothwall hinged container according to the embodiment shown in FIG. 8; and,

FIG. 14 is a left side view of the smoothwall hinged container according to the embodiment shown in FIG. 8.

1 Claim, 14 Drawing Sheets

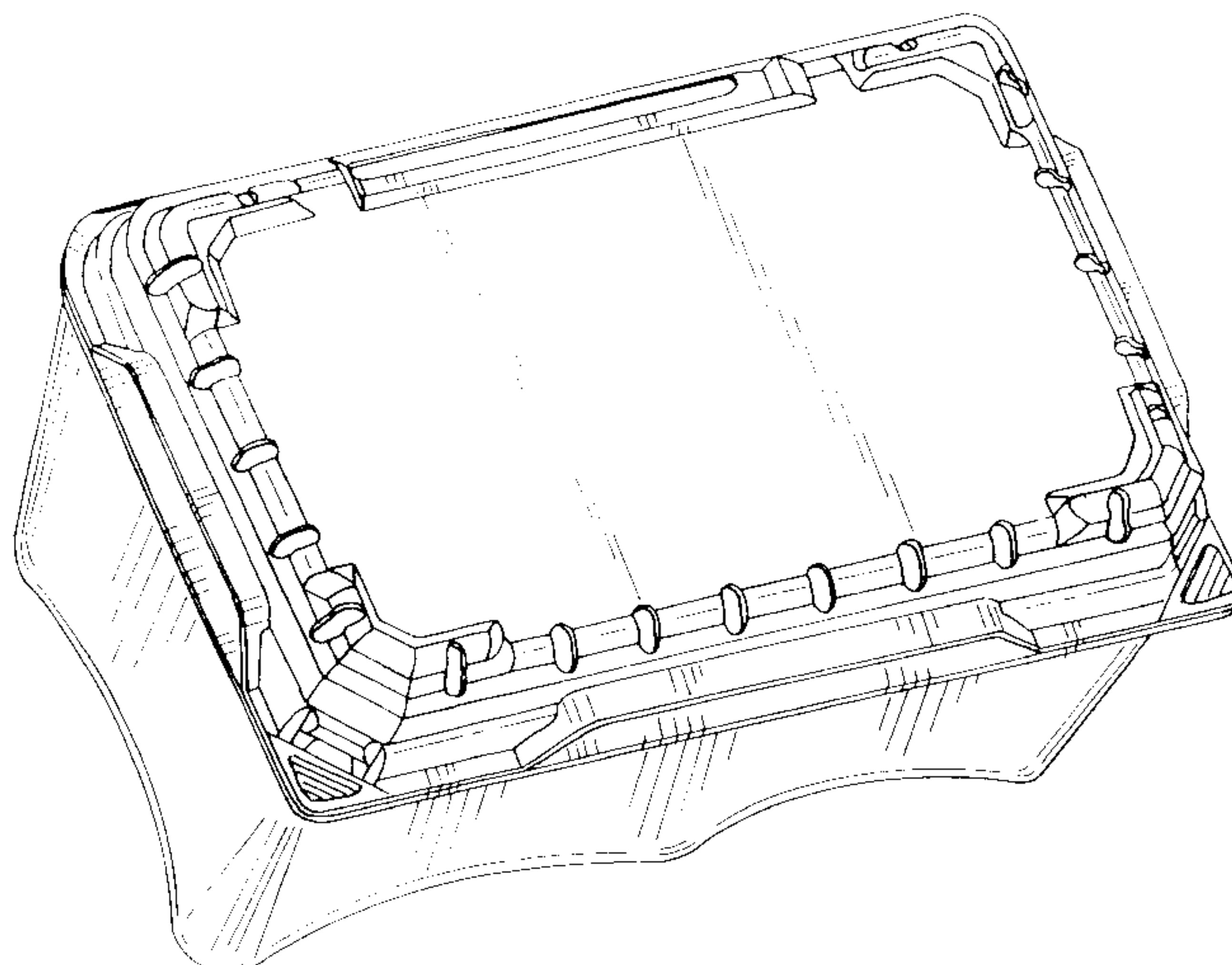

US D467,496 S

Page 2

U.S. PATENT DOCUMENTS							
D361,036 S	8/1995	Krupa	D9/424	5,738,890 A	4/1998	Cadiente et al.	426/106
5,456,379 A	10/1995	Krupa et al.	220/339	5,947,321 A	9/1999	Vadney	220/367.1
D363,879 S	11/1995	Krupa et al.	D9/423	6,007,854 A	12/1999	Cadiente et al.	426/106
5,515,993 A	5/1996	McManus	220/339	6,074,676 A	6/2000	Cadiente et al.	426/106
D382,795 S	8/1997	Abayhan et al.	D9/425	6,257,401 B1	7/2001	Mangla et al.	206/204
D393,204 S	4/1998	Goins et al.	D9/425	D448,288 S *	9/2001	Zettle et al.	D9/425

* cited by examiner

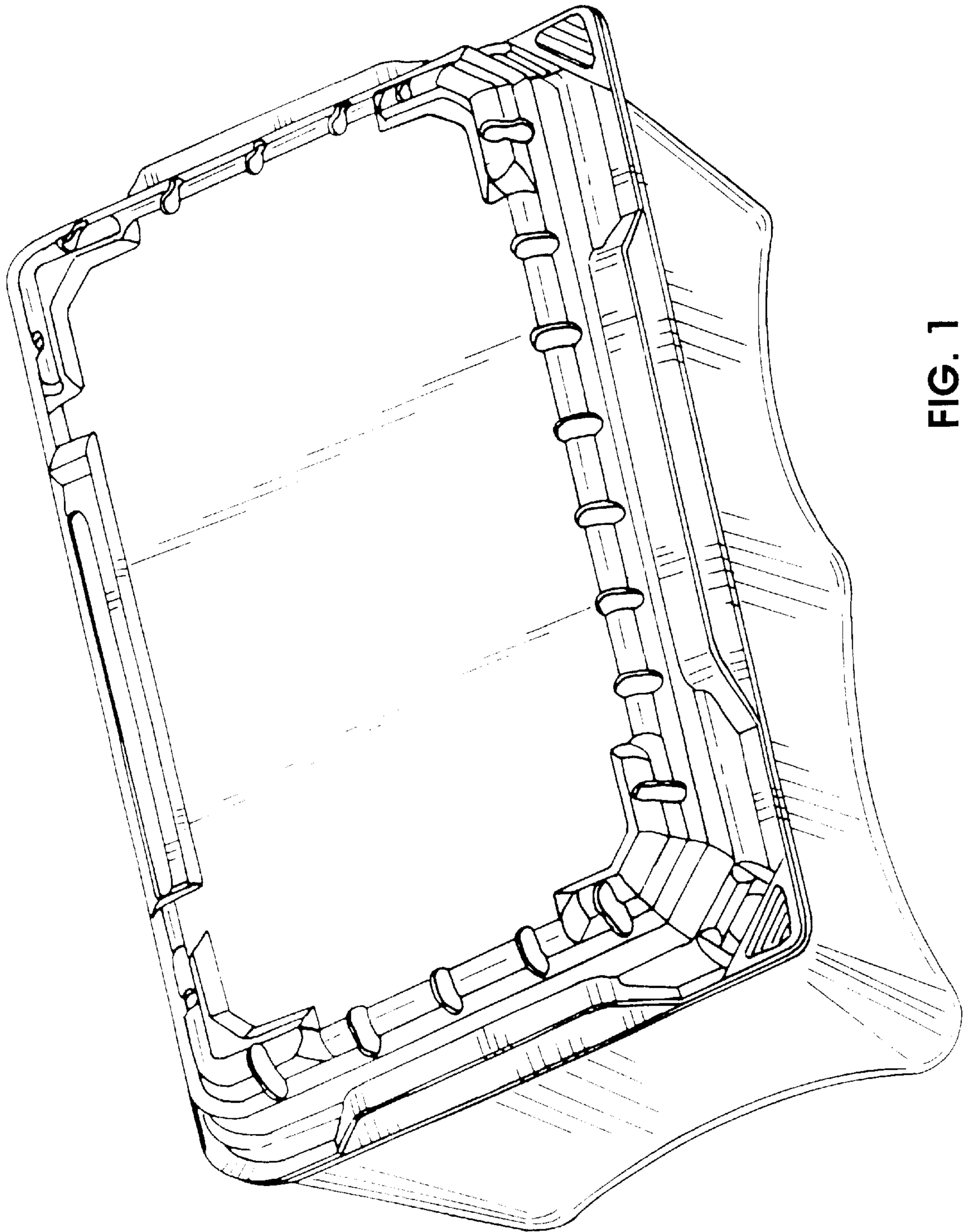

FIG. 1

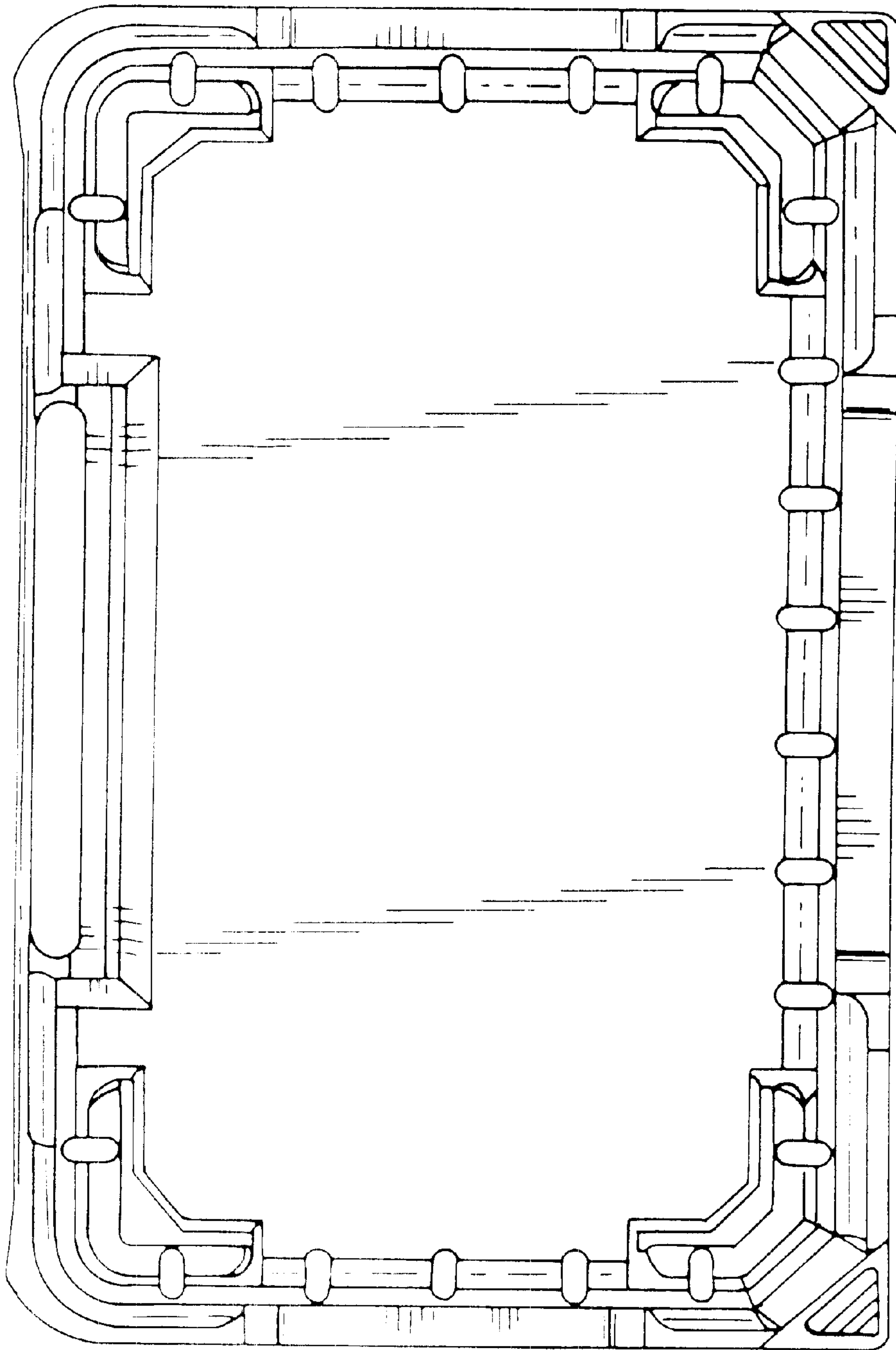

FIG. 2

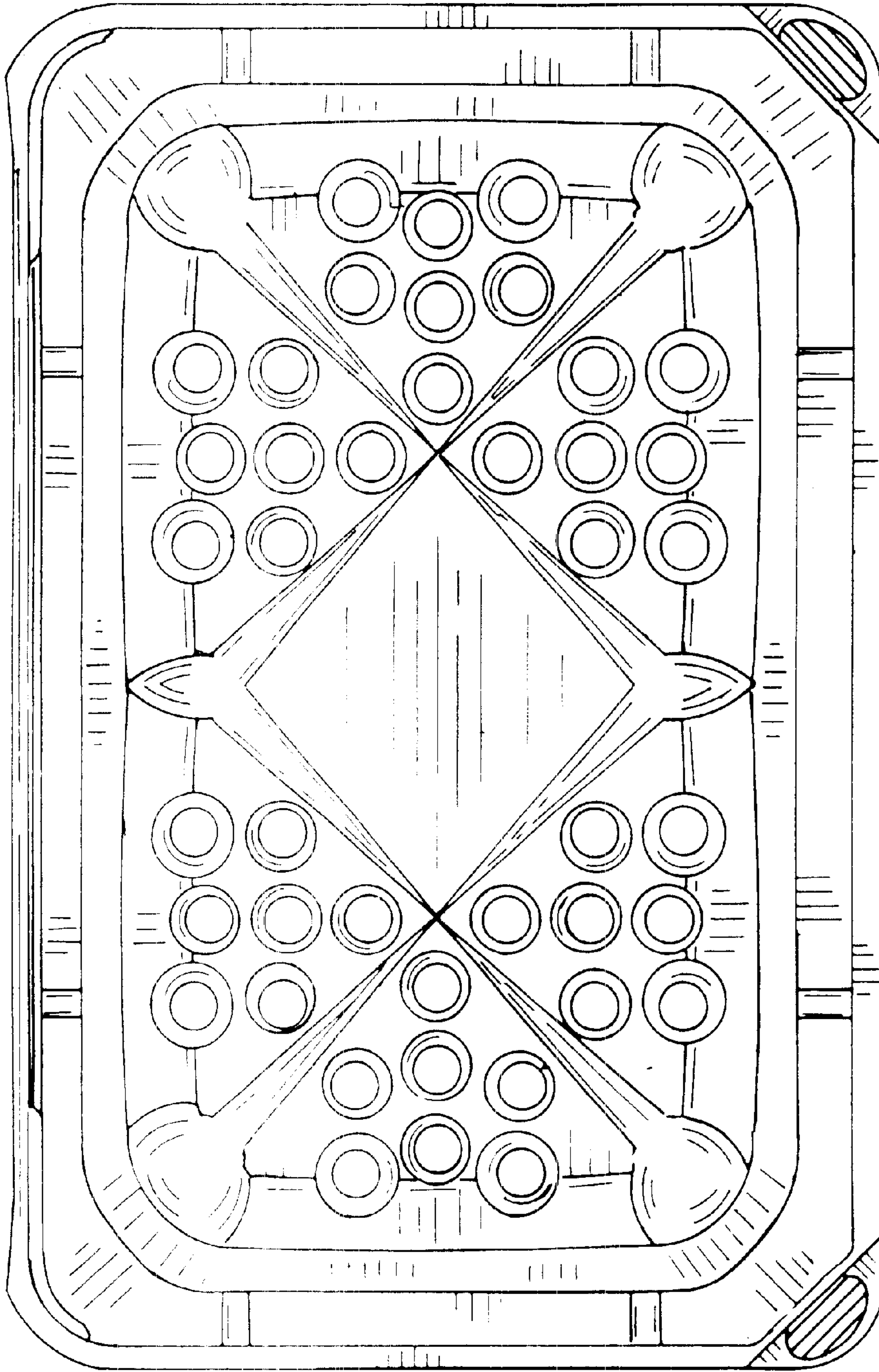

FIG. 3

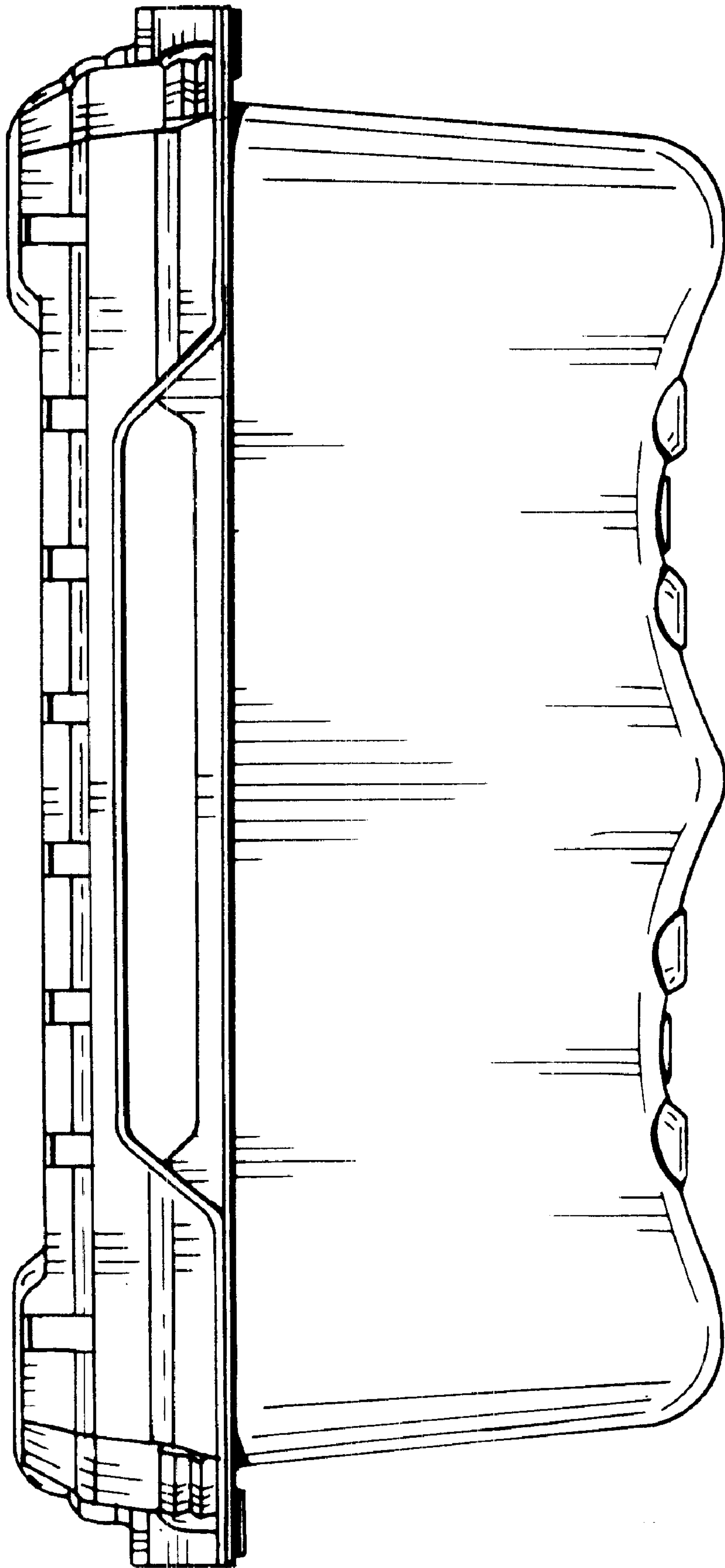

FIG. 4

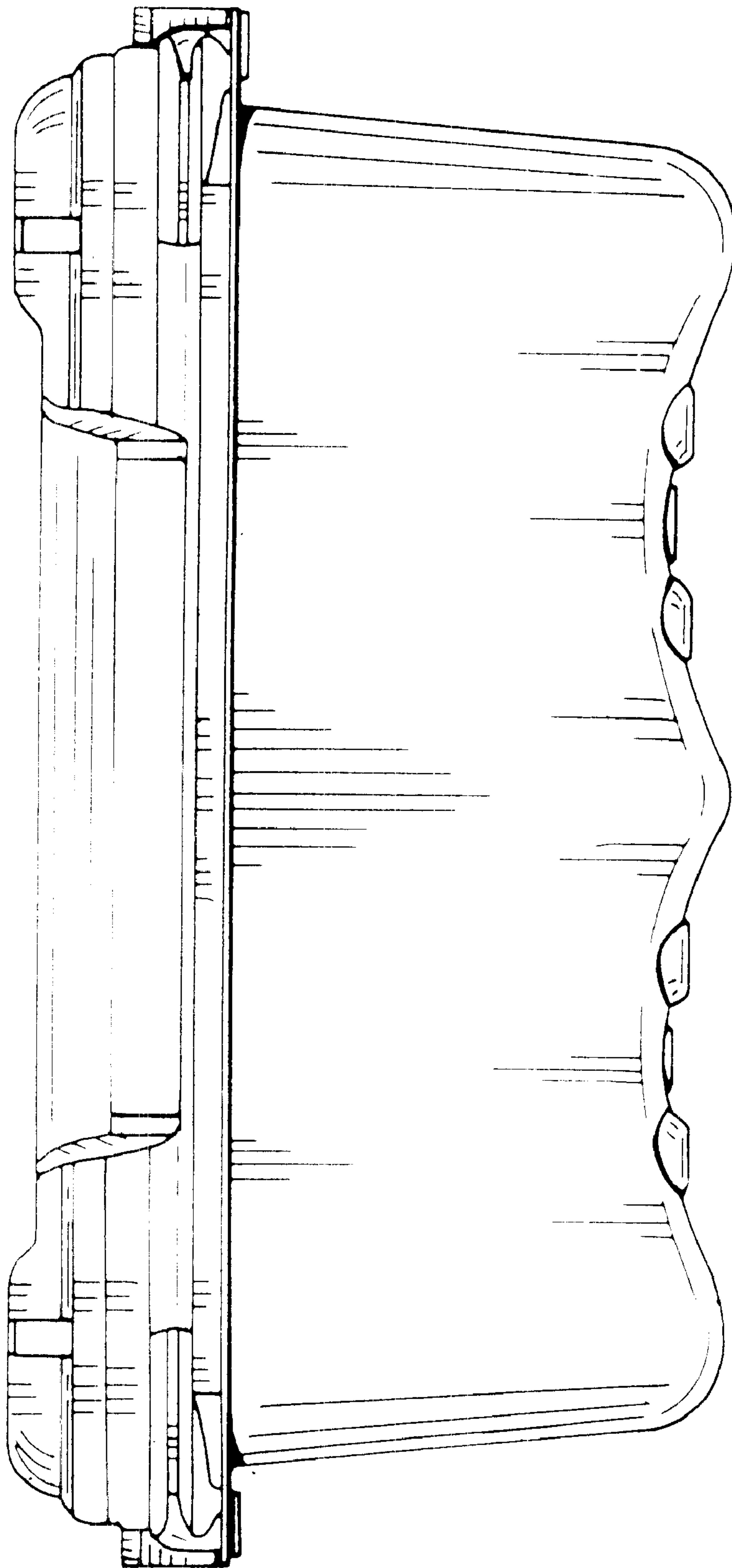

FIG. 5

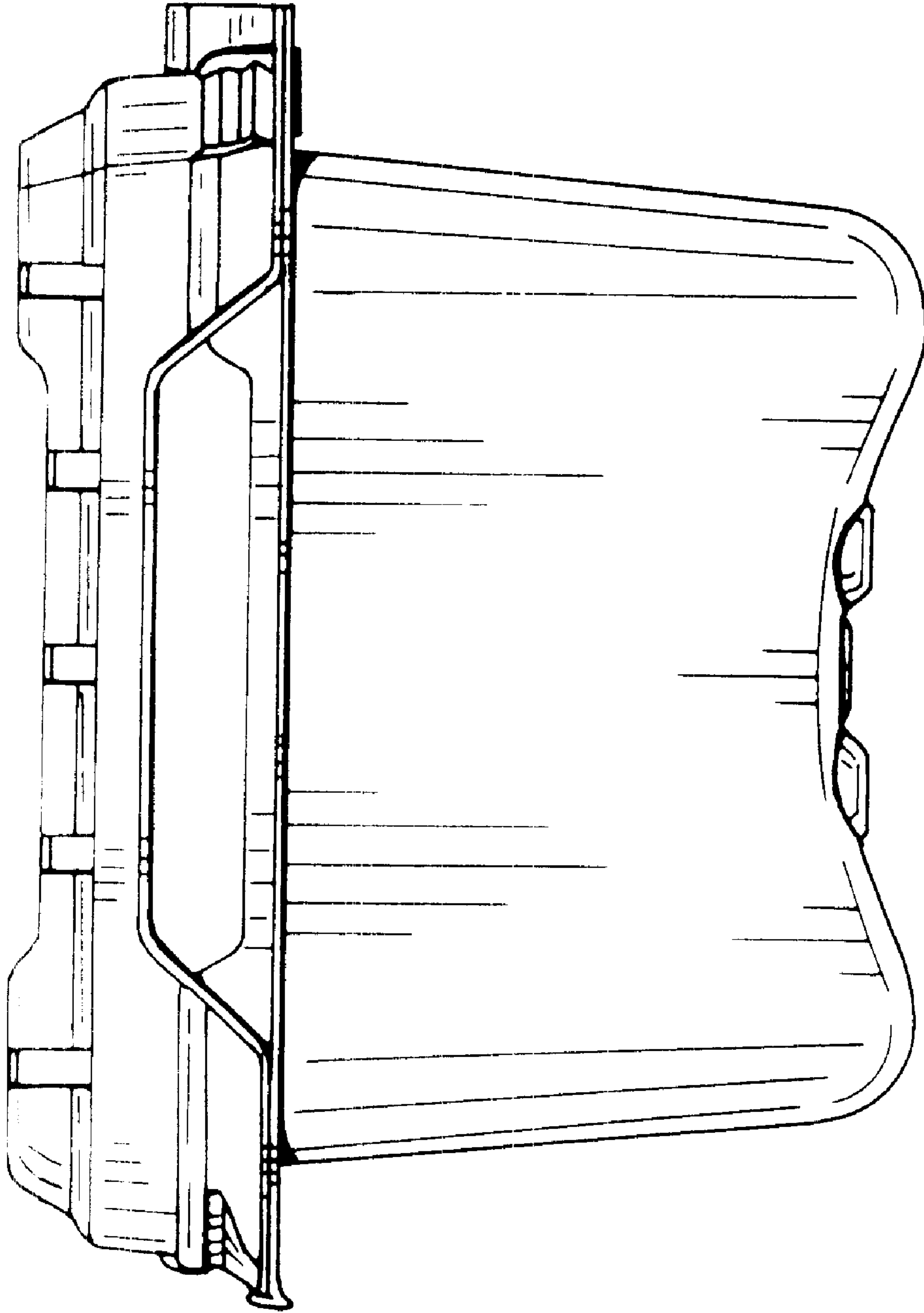

FIG. 6

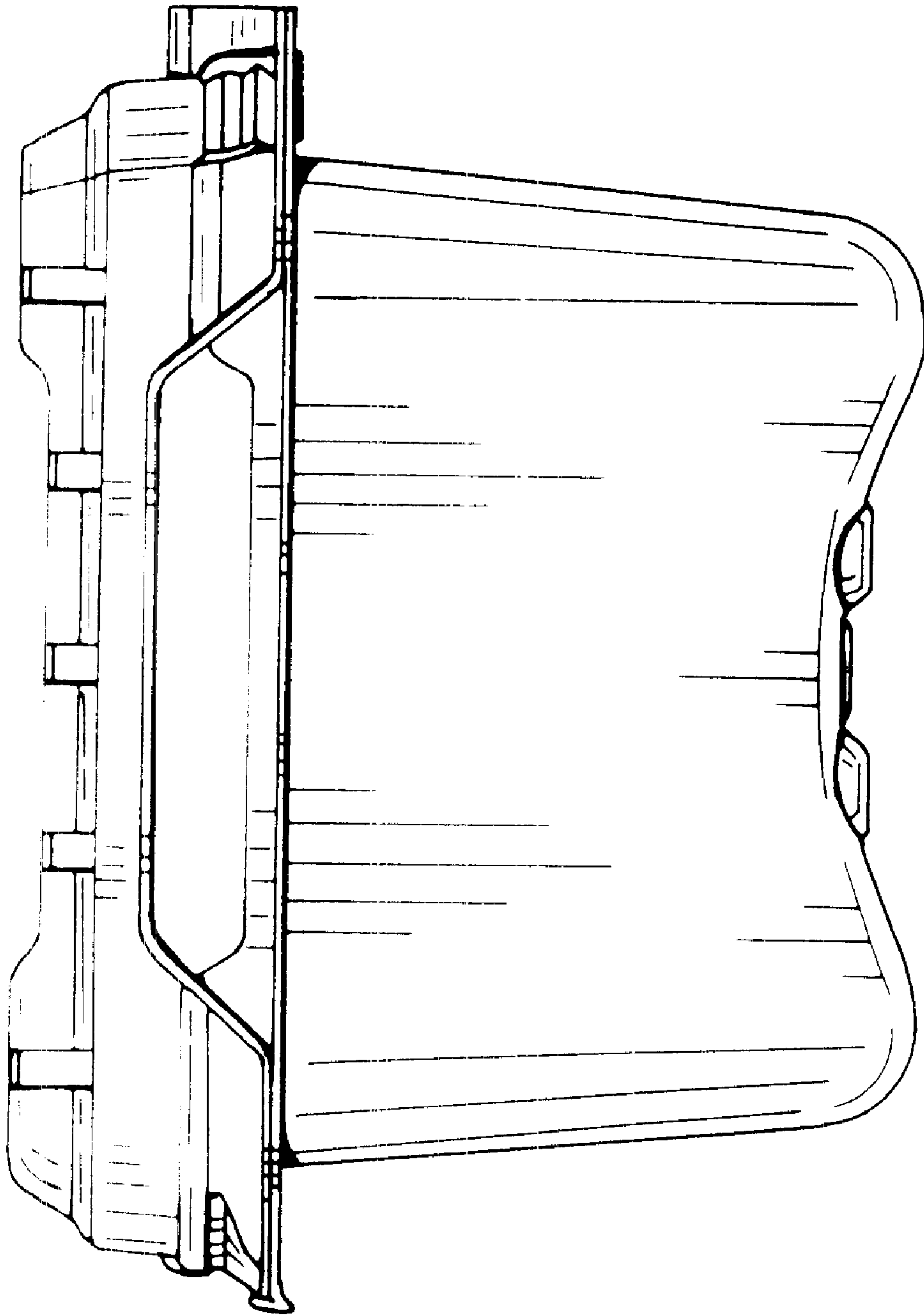

FIG. 7

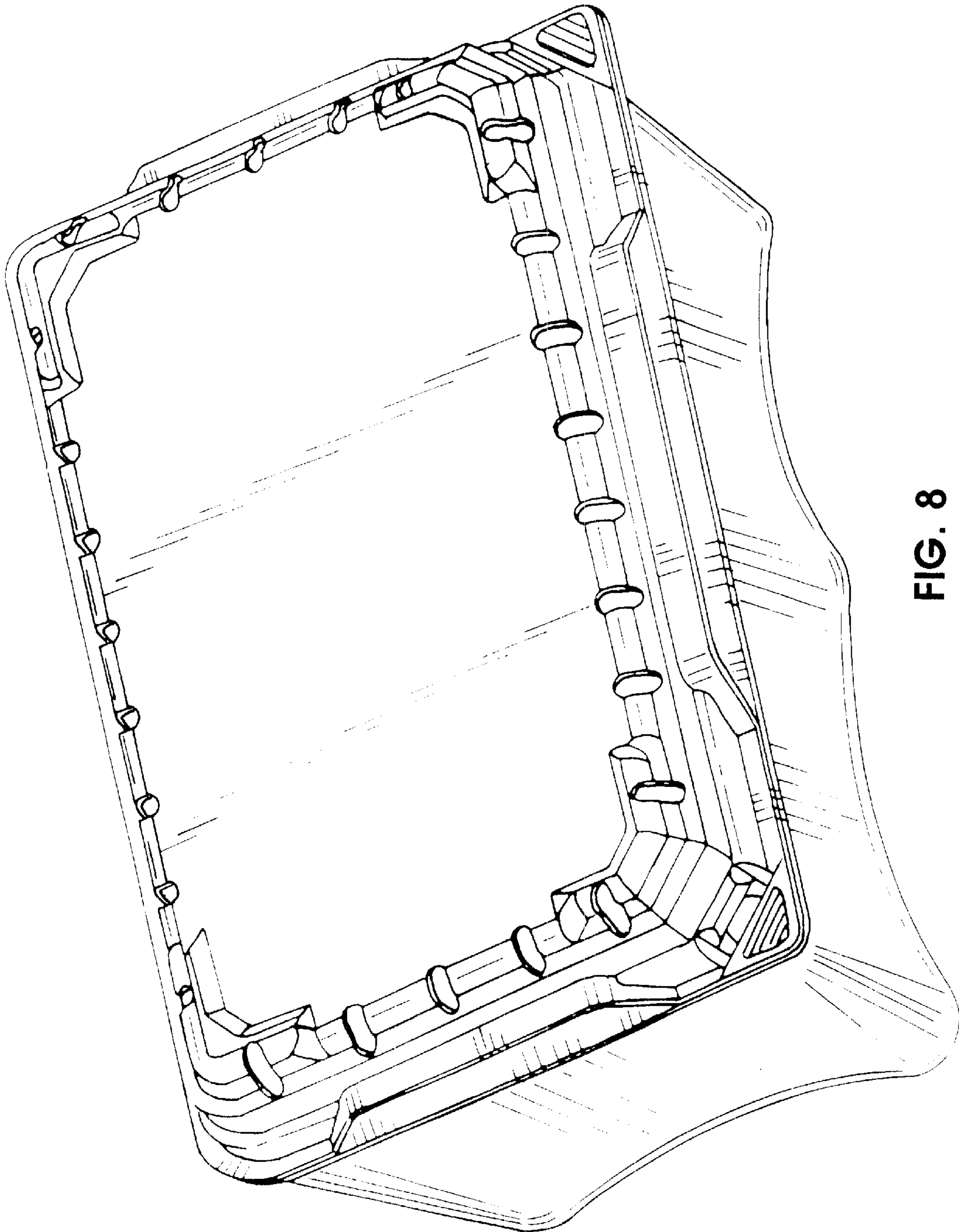

FIG. 8

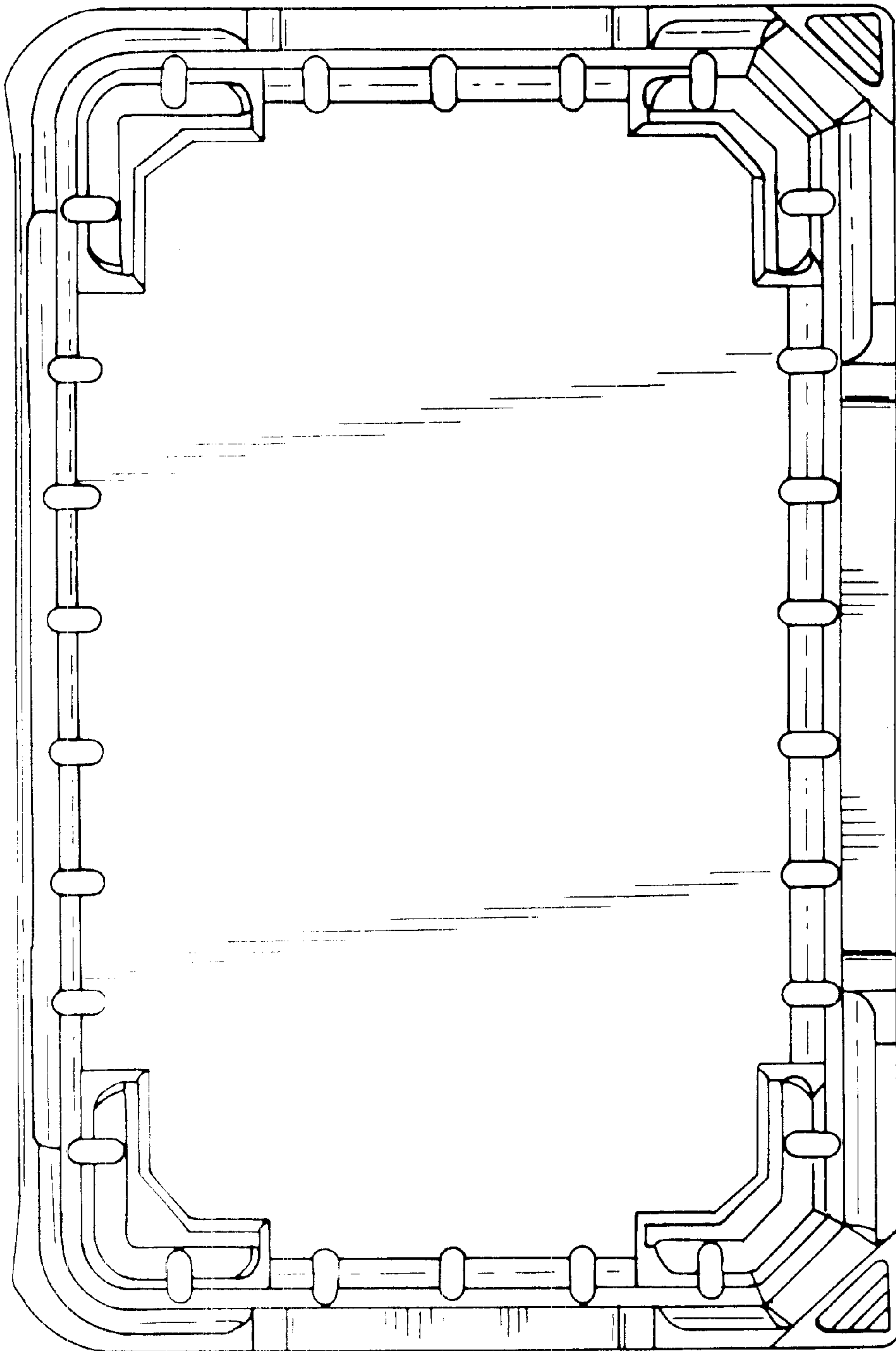

FIG. 9

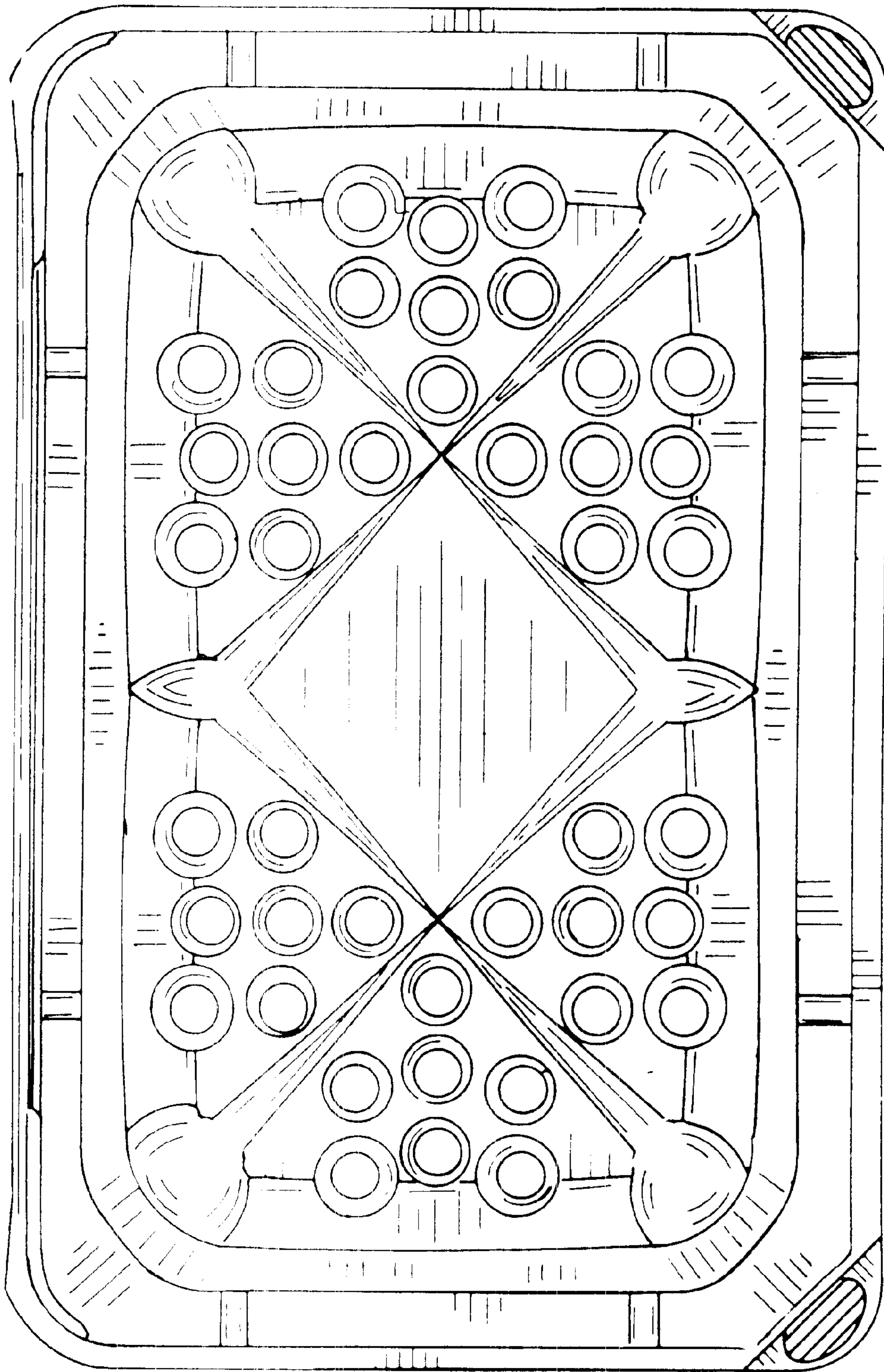

FIG. 10

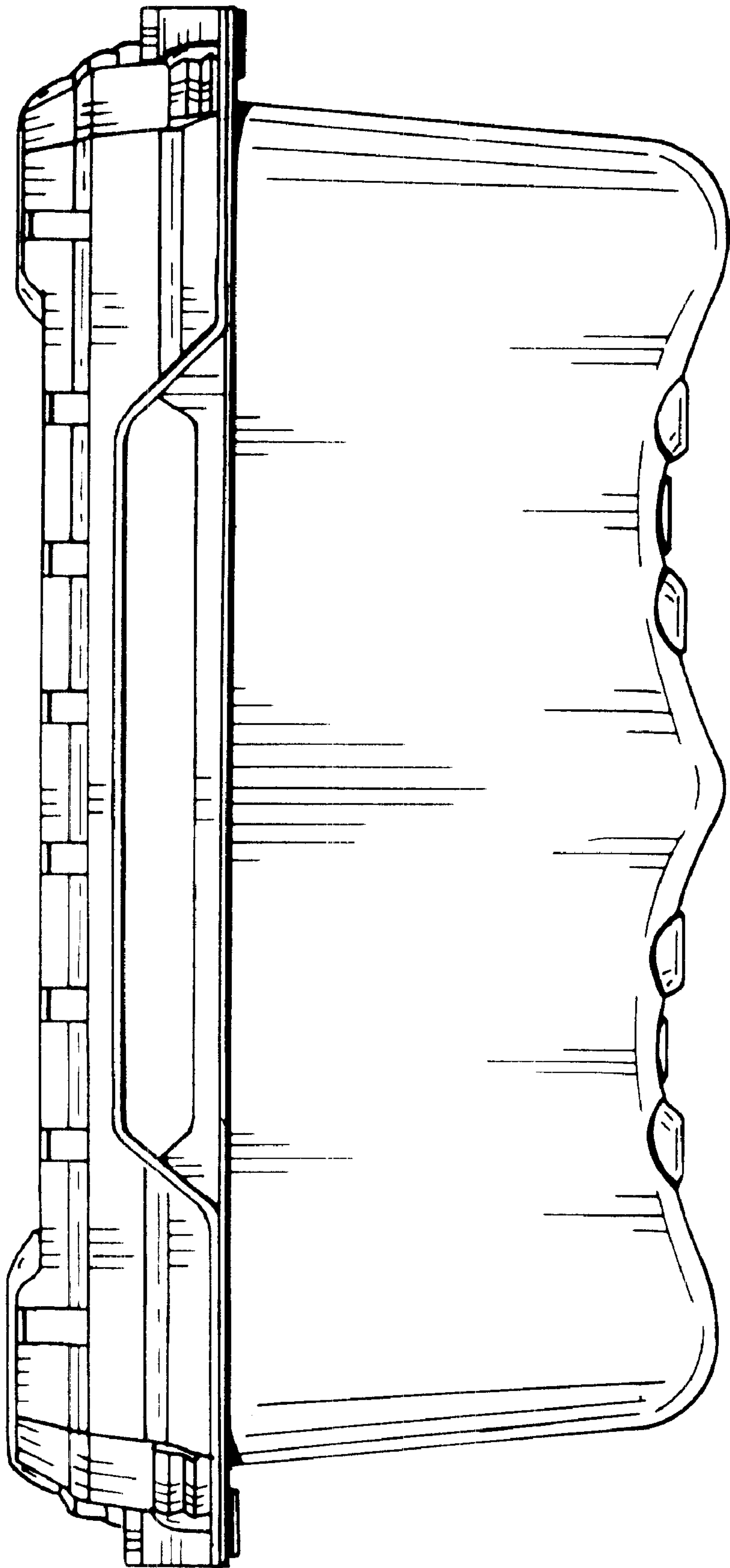

FIG. 11

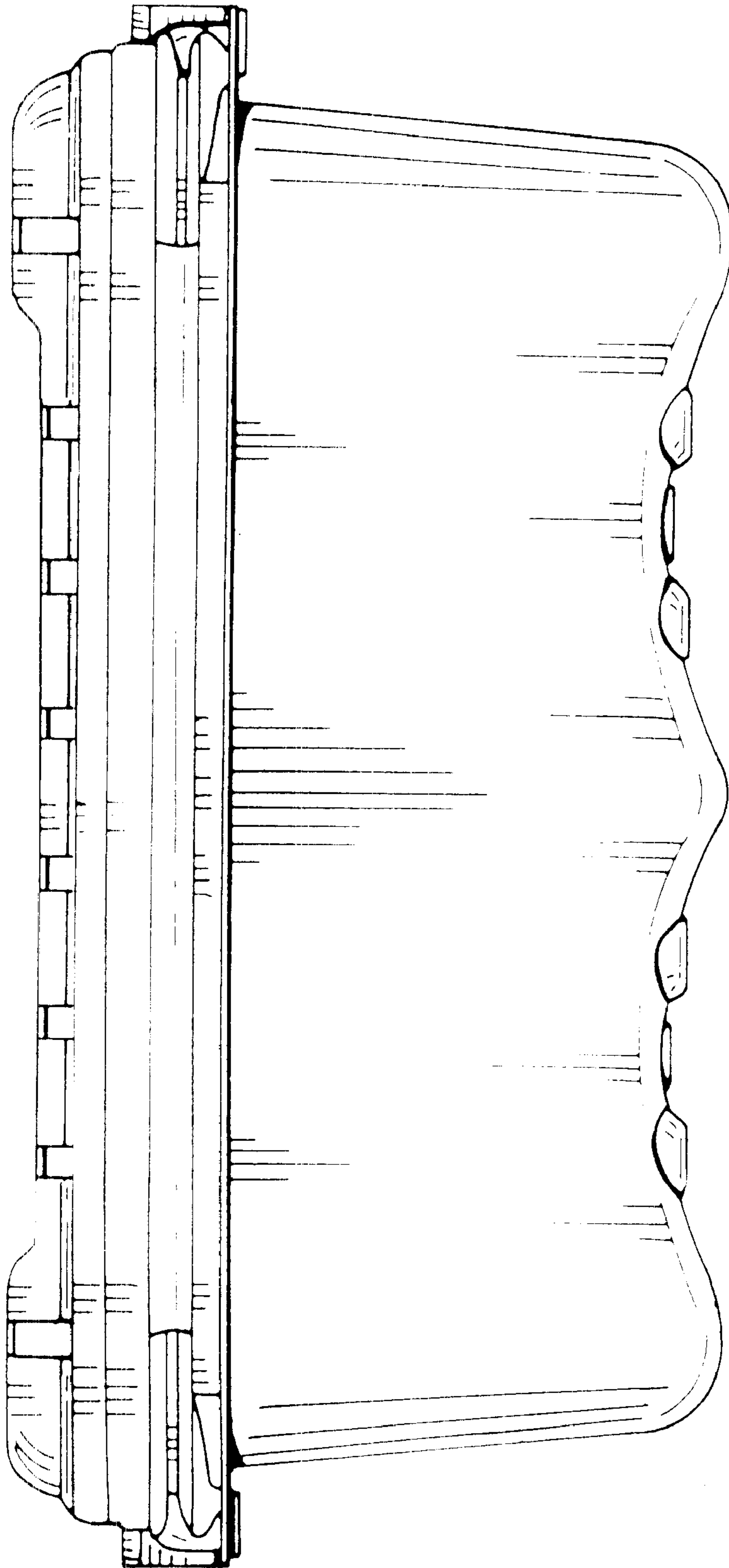

FIG. 12

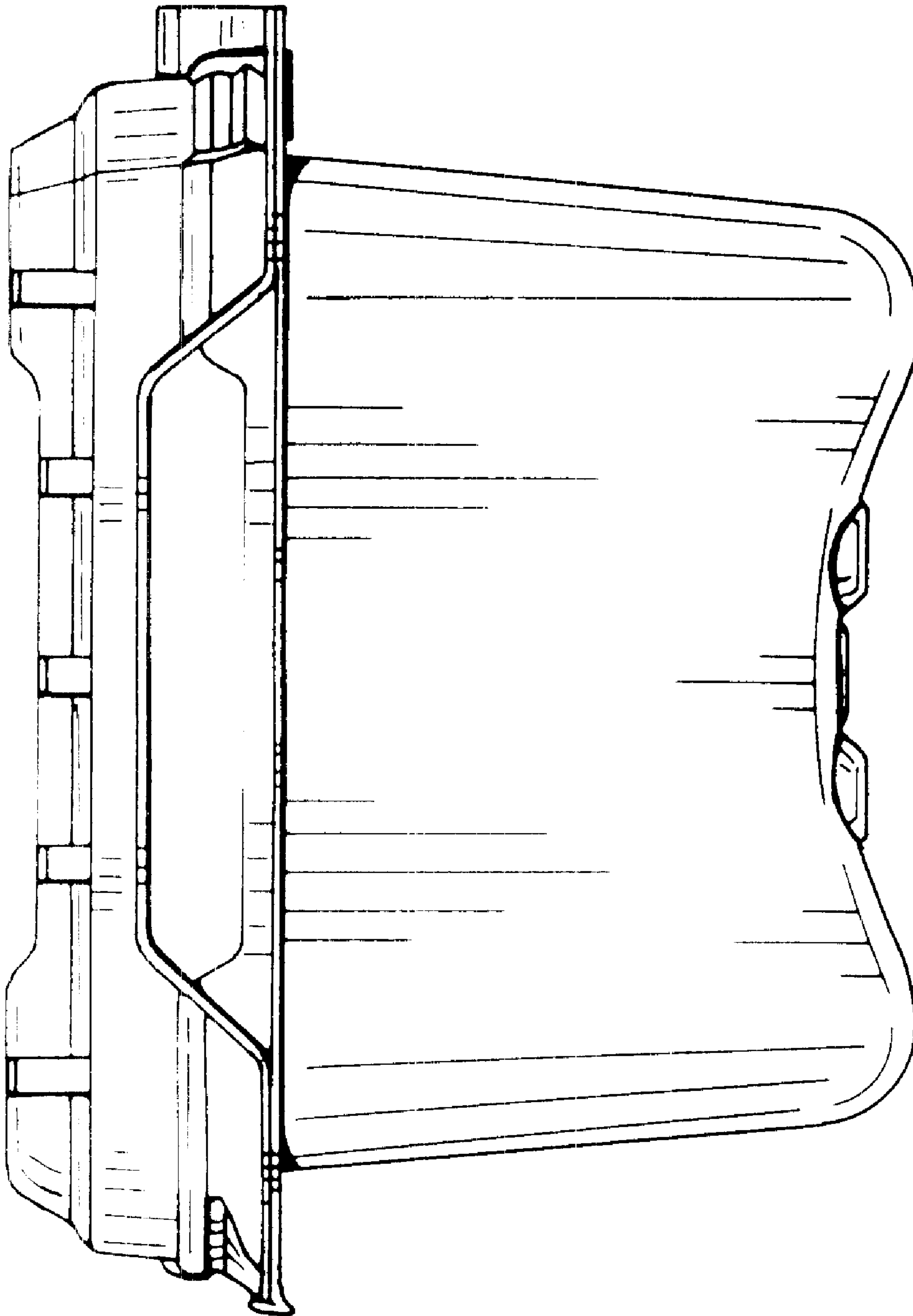

FIG. 13

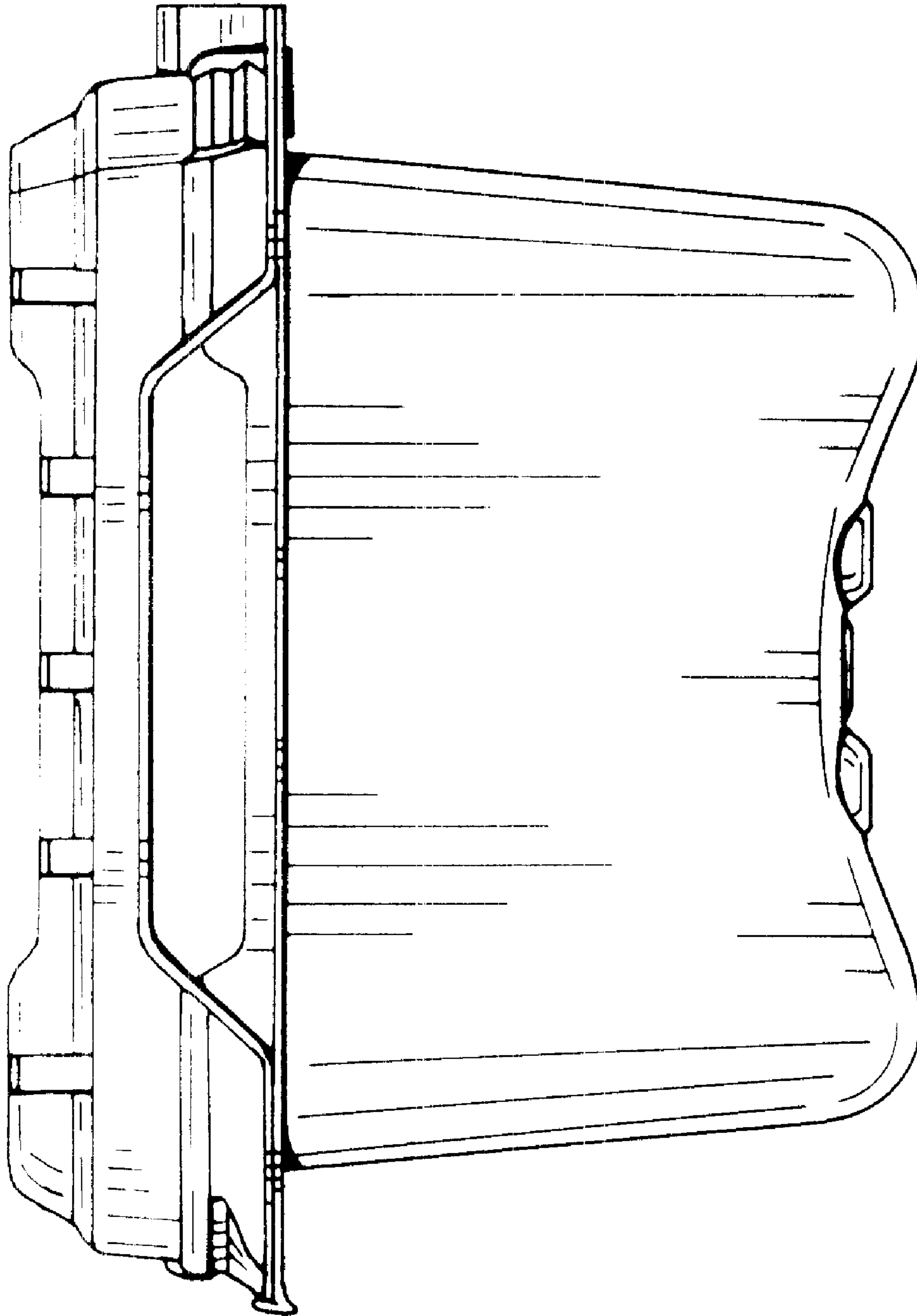

FIG. 14