



US00D467394S

(12) **United States Design Patent**
Schumaier

(10) **Patent No.:** **US D467,394 S**

(45) **Date of Patent:** **** Dec. 17, 2002**

(54) **HEARING AID DRYING APPLIANCE**

5,852,879 A 12/1998 Schumaier
D406,416 S * 3/1999 Chan D32/1
D413,304 S * 8/1999 Moehler D13/147

(75) **Inventor:** **Daniel R. Schumaier**, Elizabethton, TN (US)

* cited by examiner

(73) **Assignee:** **Ear Technology Corporation**, Johnson City, TN (US)

Primary Examiner—Nelson C. Holtje
(74) *Attorney, Agent, or Firm*—Luedeka, Neely & Graham, P.C.

(**) **Term:** **14 Years**

(21) **Appl. No.:** **29/151,448**

(57) **CLAIM**

(22) **Filed:** **Dec. 3, 2001**

The ornamental design of a hearing aid drying appliance, as shown.

(51) **LOC (7) Cl.** **15-05**

DESCRIPTION

(52) **U.S. Cl.** **D32/1**

(58) **Field of Search** D32/1-2, 5, 30;
34/218-219, 225, 80; 299/222; 49/87; 43/139;
15/320, 344, 353, 329

FIG. 1 is a perspective view of the top, front and left side of a hearing aid drying appliance showing my new design; FIG. 2 is a right side view thereof; FIG. 3 is a left side view thereof; FIG. 4 is a top view thereof; FIG. 5 is a front view thereof; FIG. 6 is a bottom view thereof; and, FIG. 7 is a rear view thereof.

(56) **References Cited**

U.S. PATENT DOCUMENTS

D281,539 S * 11/1985 Harrison D32/1
D303,442 S * 9/1989 Harrison D32/1
5,640,783 A 6/1997 Schumaier

1 Claim, 2 Drawing Sheets

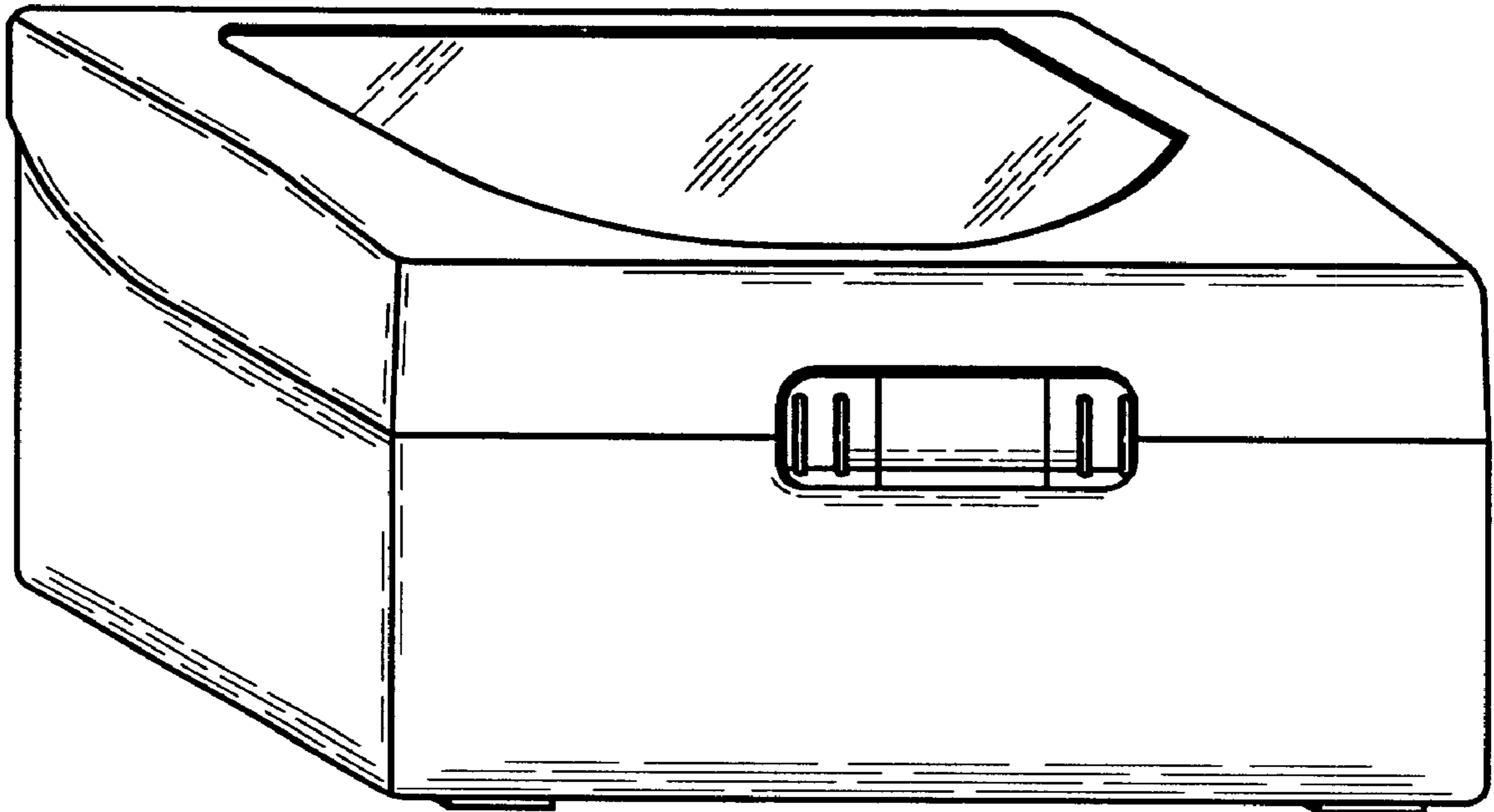

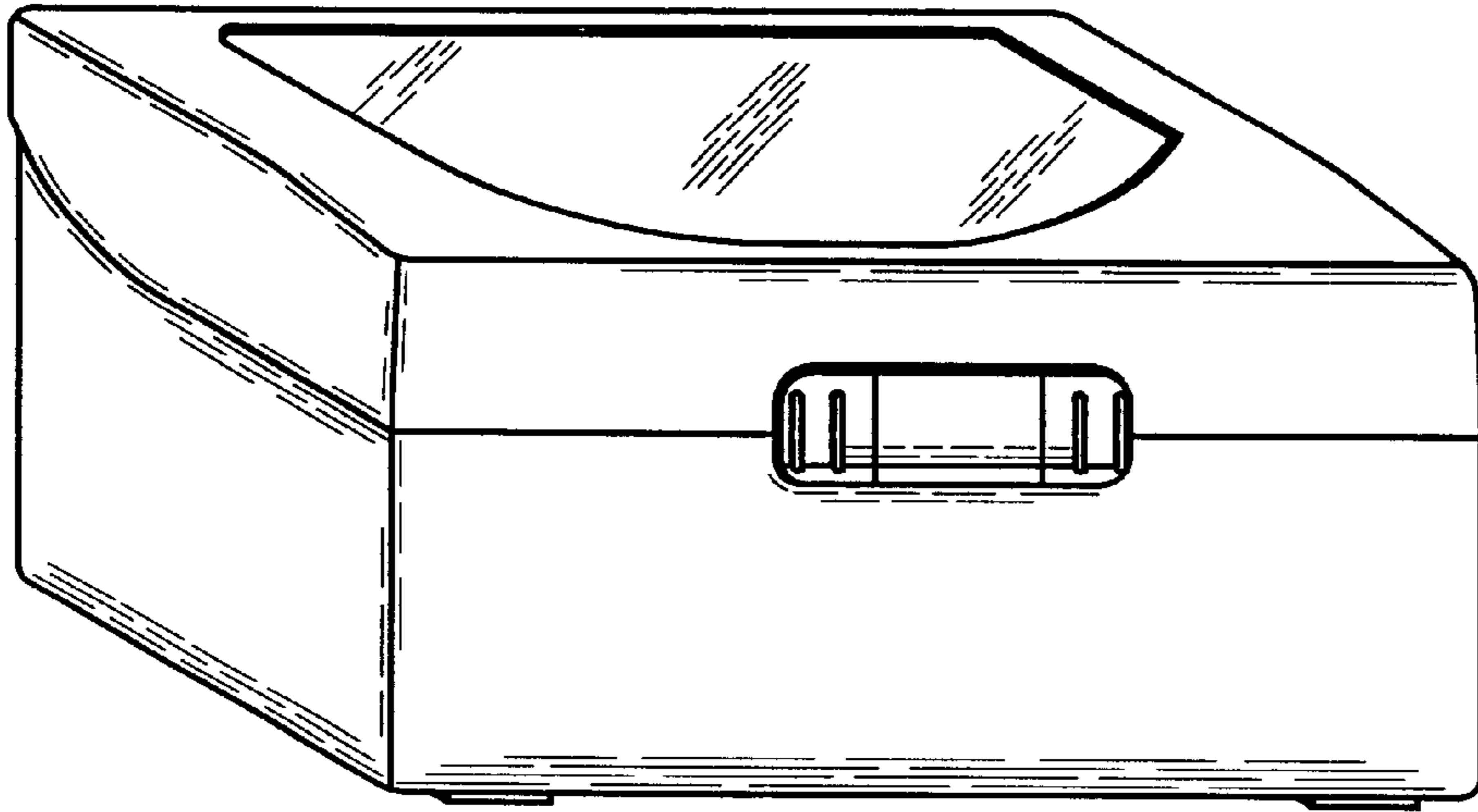

Fig. 1

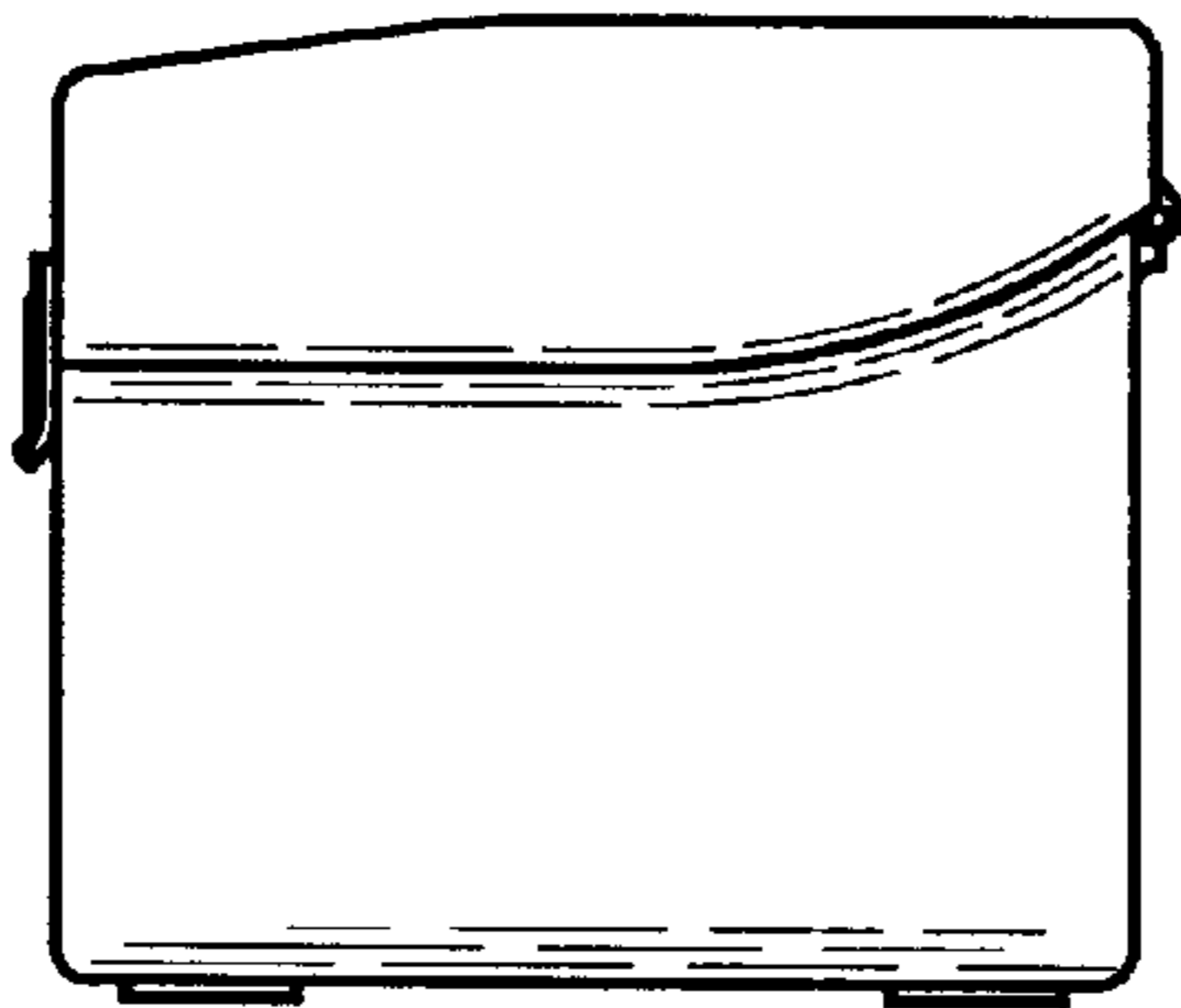

Fig. 2

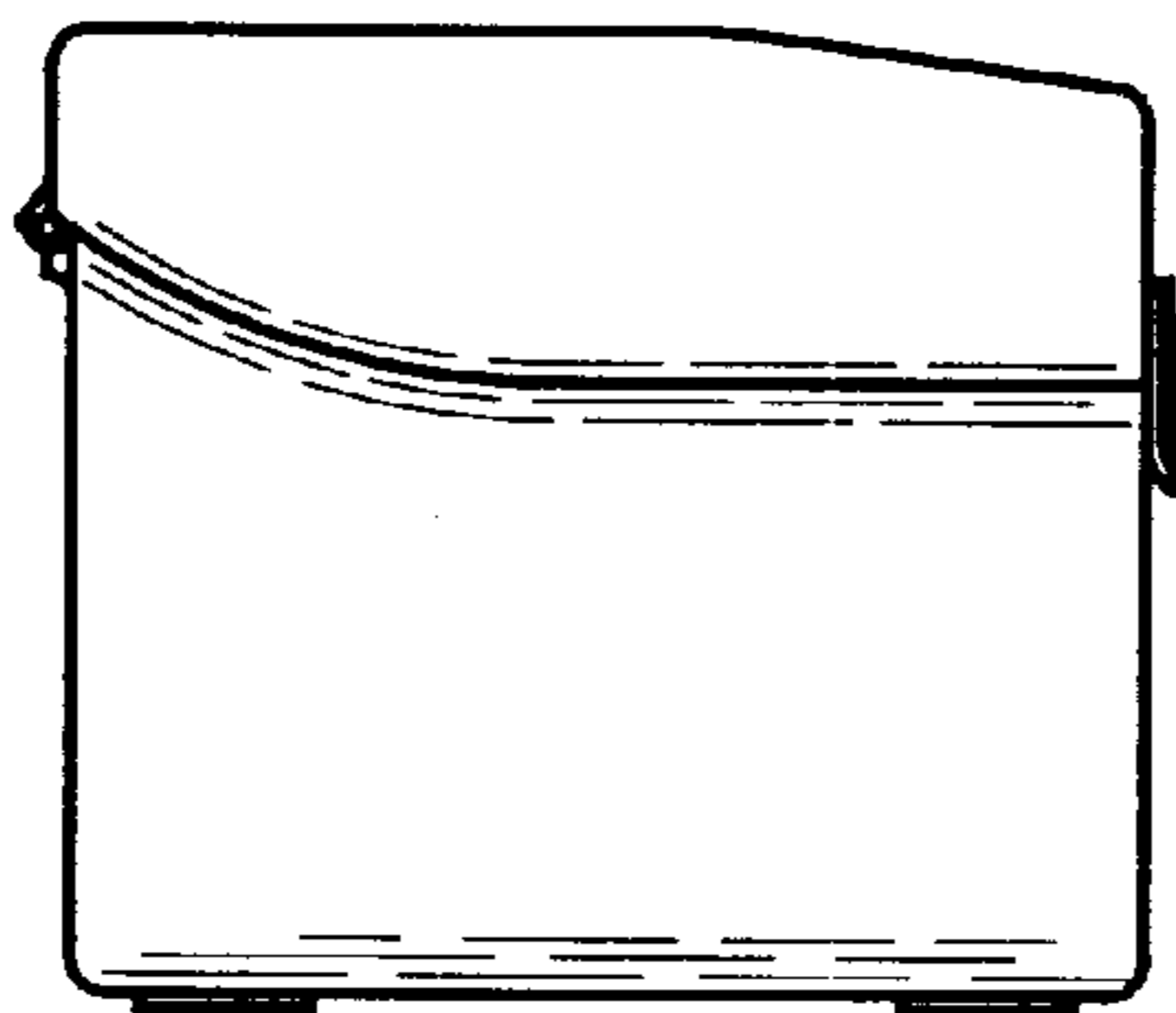

Fig. 3

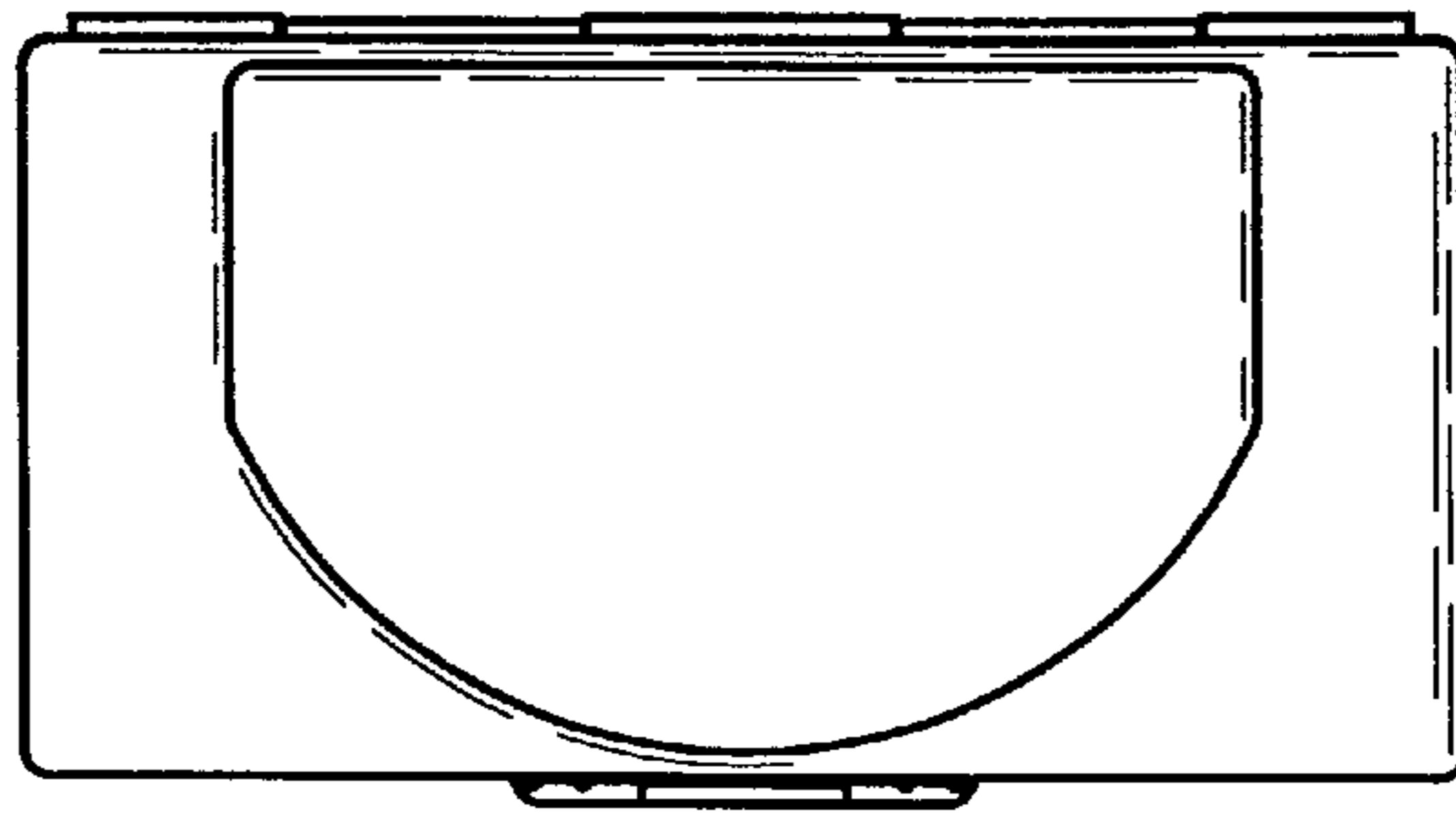

Fig. 4

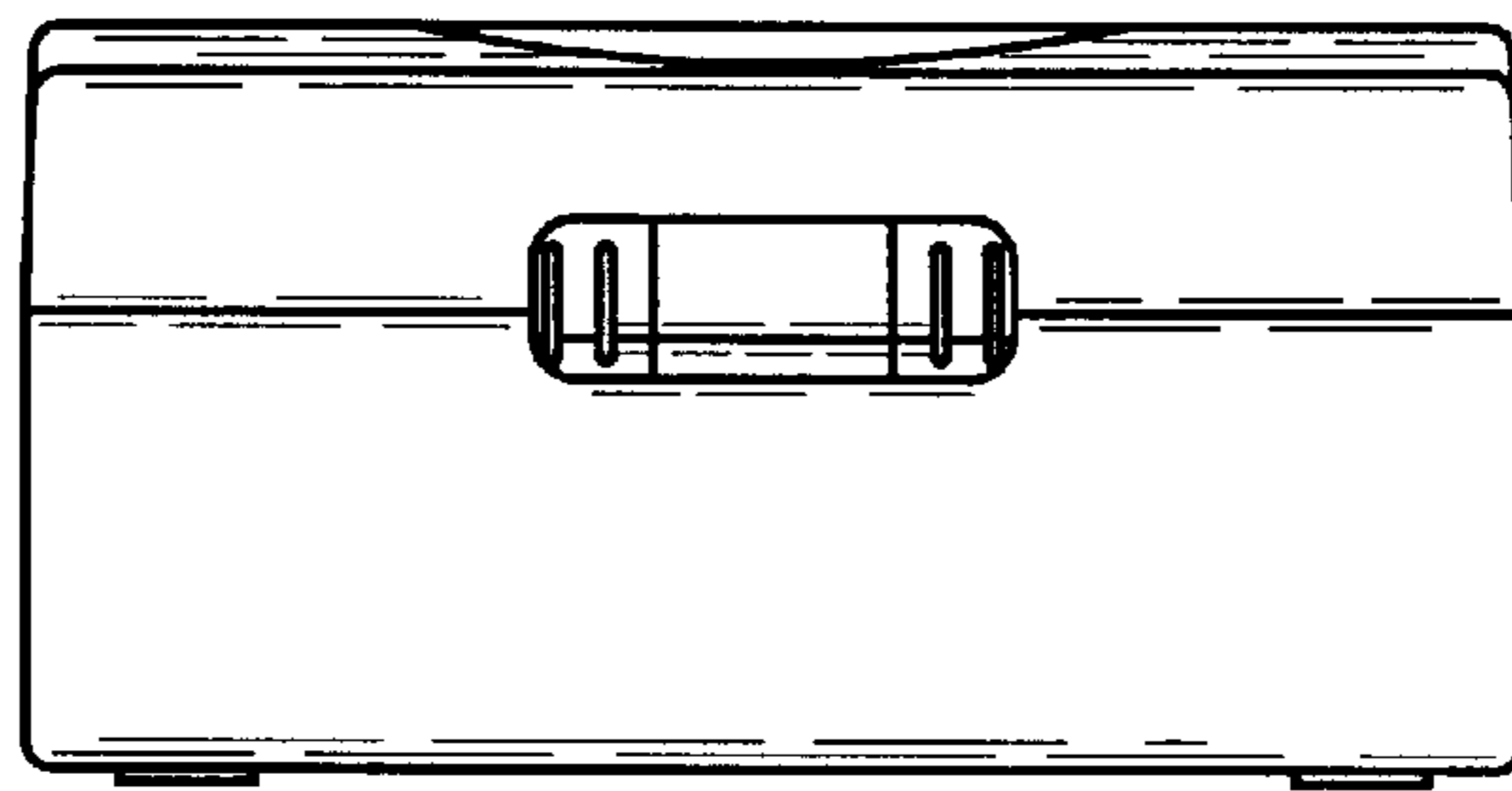

Fig. 5

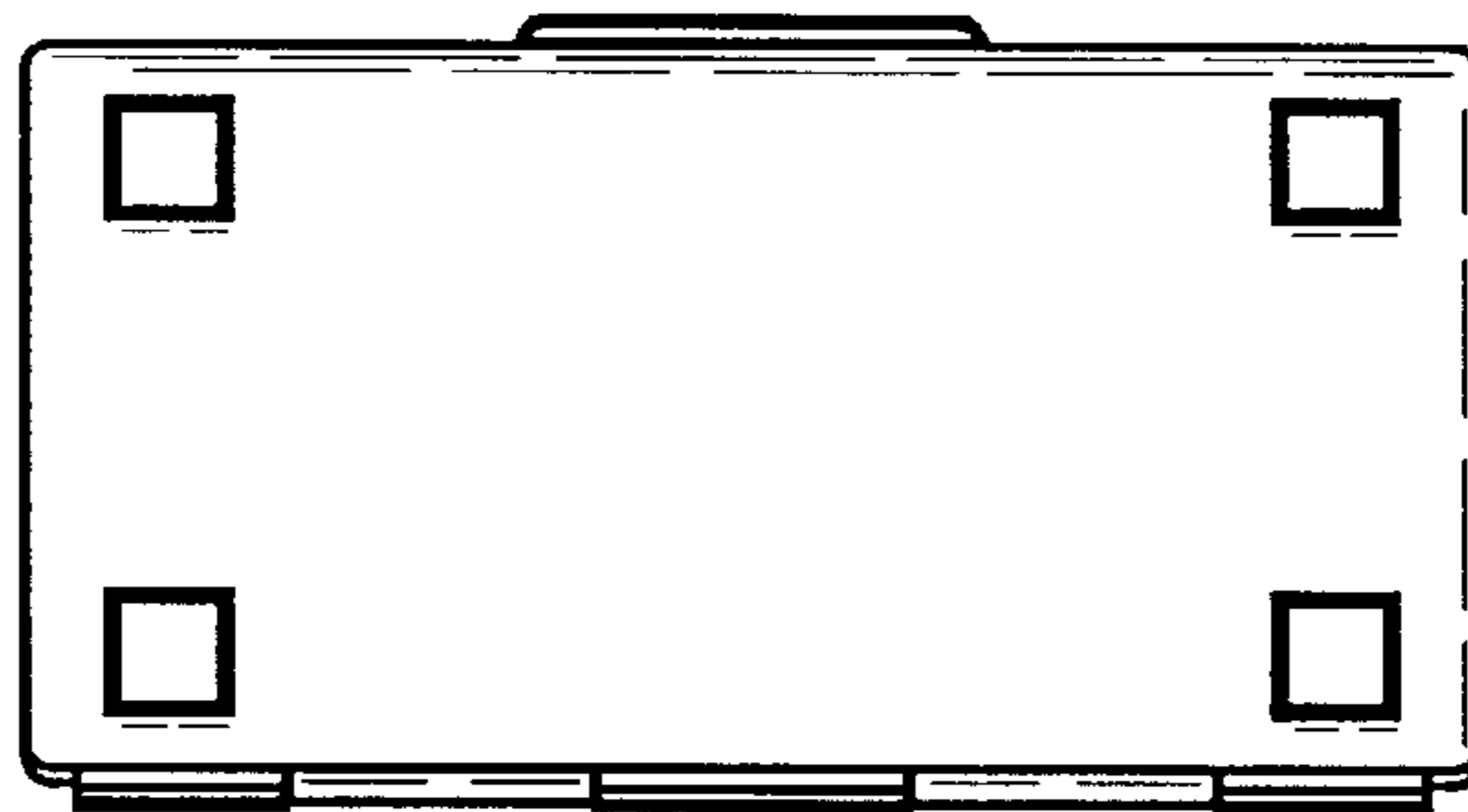

Fig. 6

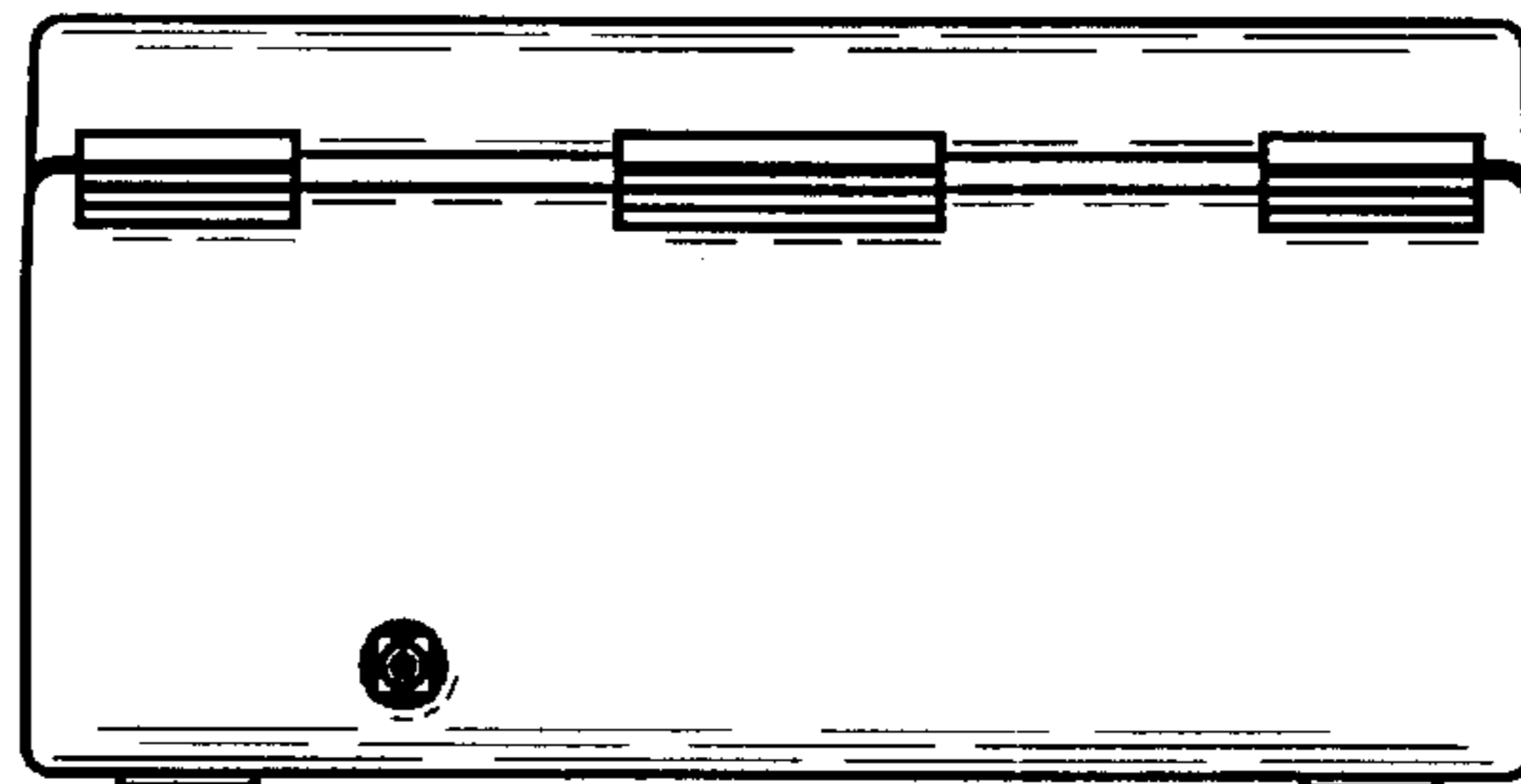

Fig. 7