



US00D467388S

(12) **United States Design Patent**
Prochaska et al.

(10) **Patent No.:** **US D467,388 S**

(45) **Date of Patent:** **** Dec. 17, 2002**

(54) **RAZOR HANDLE**

6,122,826 A * 9/2000 Coffin et al. 30/57
D441,910 S * 5/2001 Prochaska D28/48

(75) Inventors: **Frank H. Prochaska**, Waynesboro, VA (US); **Jeffrey W. Wonderley**, Fort Defiance, VA (US)

* cited by examiner

(73) Assignee: **American Safety Razor Company**, Verona, VA (US)

Primary Examiner—Mitchell Siegel

Assistant Examiner—C. Tuttle

(74) *Attorney, Agent, or Firm*—McDermott, Will & Emery

(**) Term: **14 Years**

(57) **CLAIM**

(21) Appl. No.: **29/150,487**

An ornamental design for a razor handle, as shown and described in the drawings.

(22) Filed: **Nov. 26, 2001**

DESCRIPTION

(51) **LOC (7) Cl.** **28-03**

FIG. 1 is a front perspective view of the razor handle showing the new design;

(52) **U.S. Cl.** **D28/48**

FIG. 2 is a side view of the razor handle;

(58) **Field of Search** D28/44-48; 30/32, 30/34.05, 41, 47-51, 526-527, 530-533

FIG. 3 is a top view of the razor handle;

FIG. 4 is a bottom view of the razor handle;

FIG. 5 is a front view of the razor handle; and,

FIG. 6 is a rear view of the razor handle.

(56) **References Cited**

U.S. PATENT DOCUMENTS

4,308,663 A * 1/1982 Ciaffone 30/531
4,599,793 A * 7/1986 Iten 30/47
D397,830 S * 9/1998 Gray D28/48
D403,113 S * 12/1998 Kohring et al. D28/48

The portions of the razor handle shown in broken lines are for illustrative purposes only and forms no part of the claimed design.

1 Claim, 5 Drawing Sheets

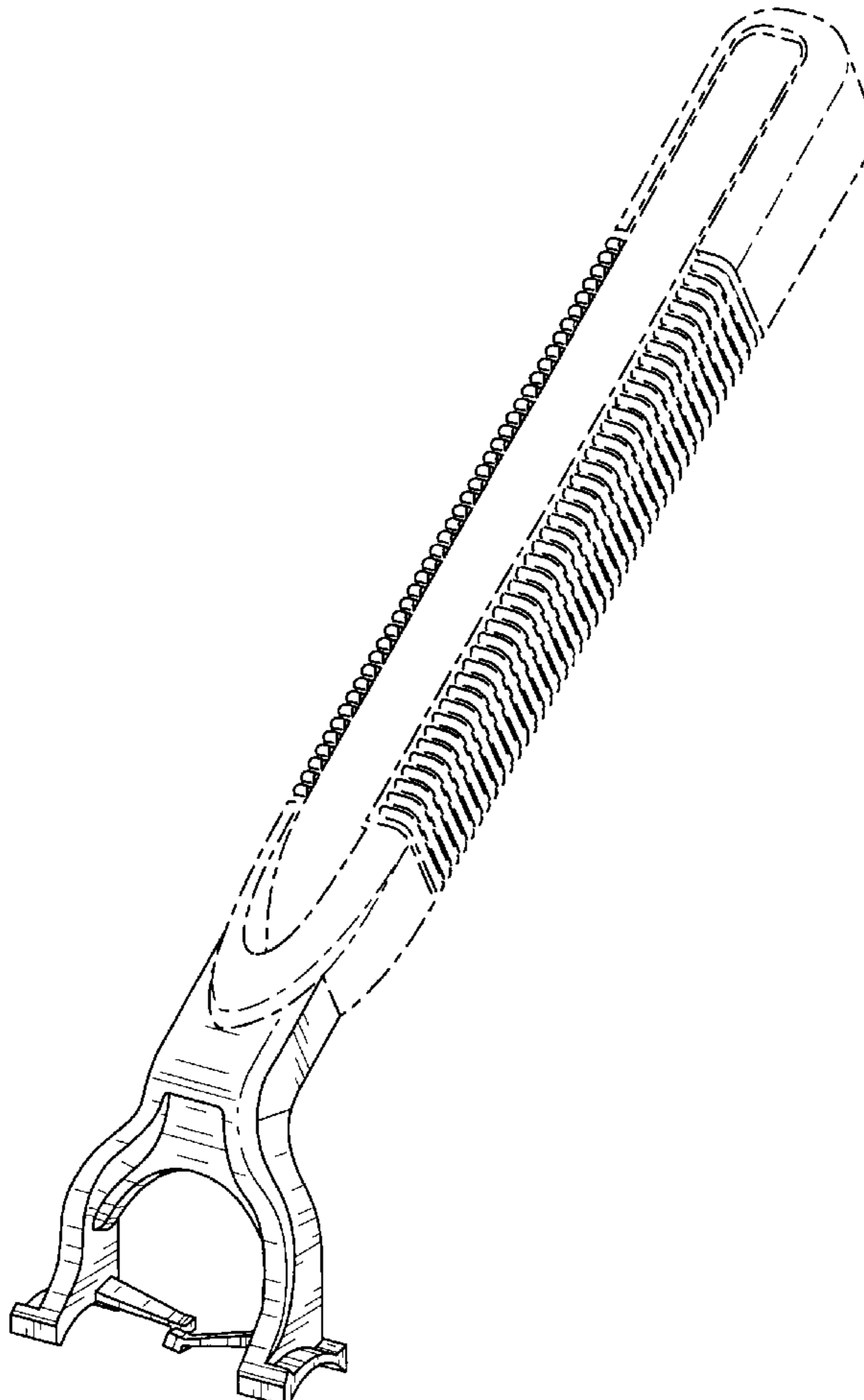

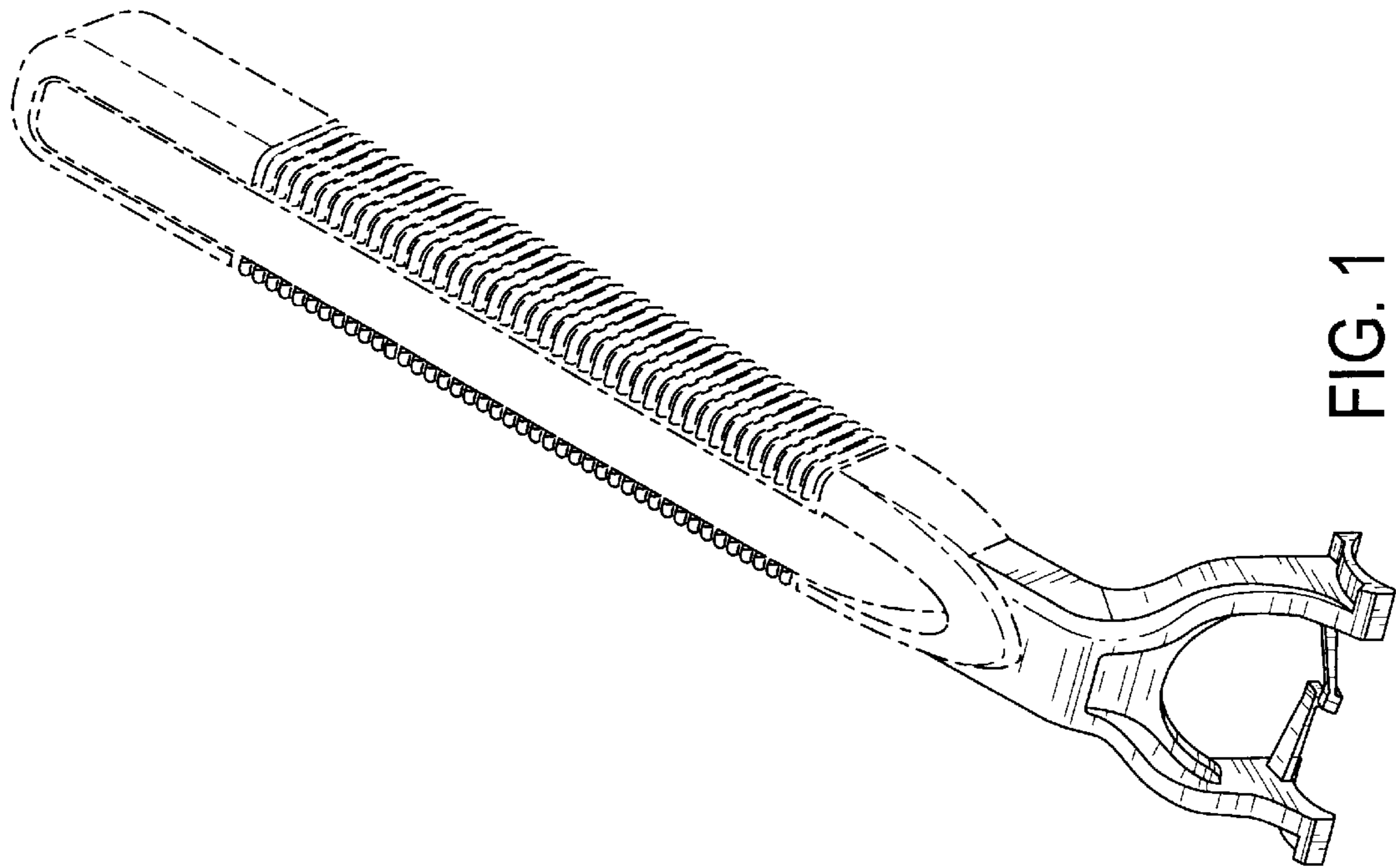

FIG. 1

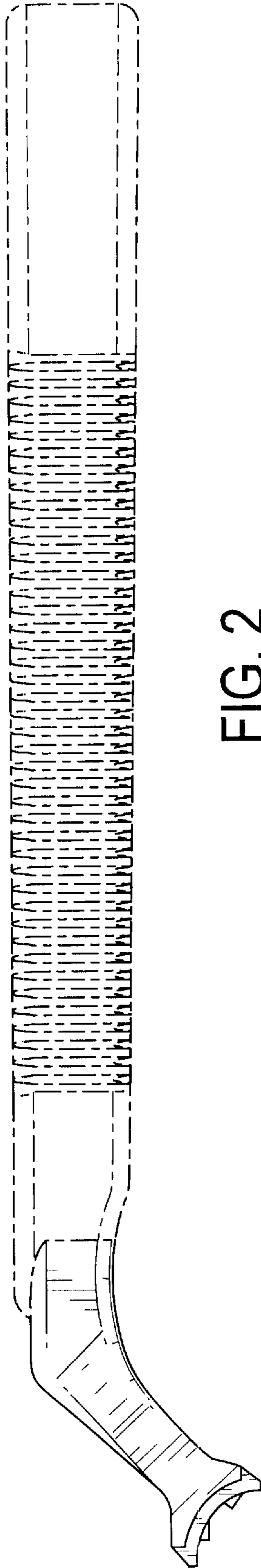

FIG. 2

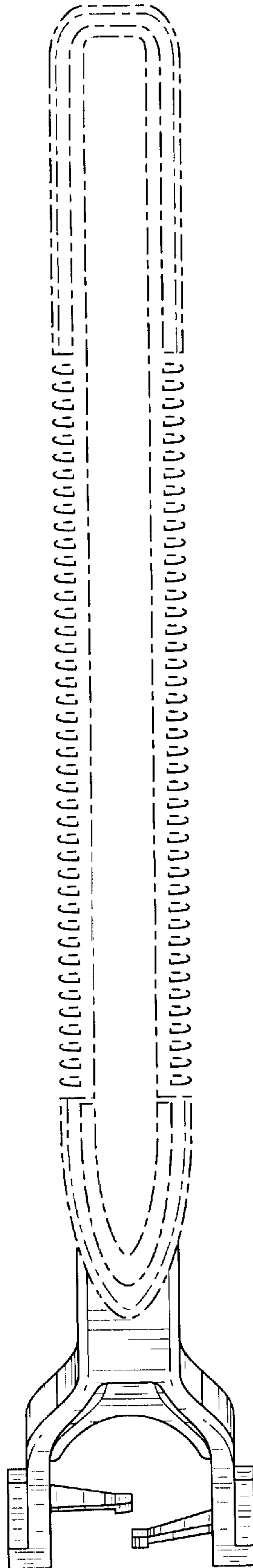

FIG. 3

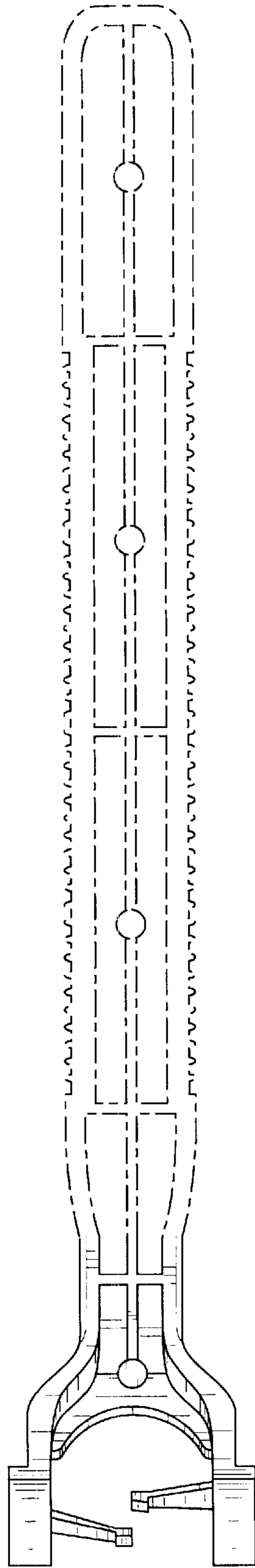

FIG. 4

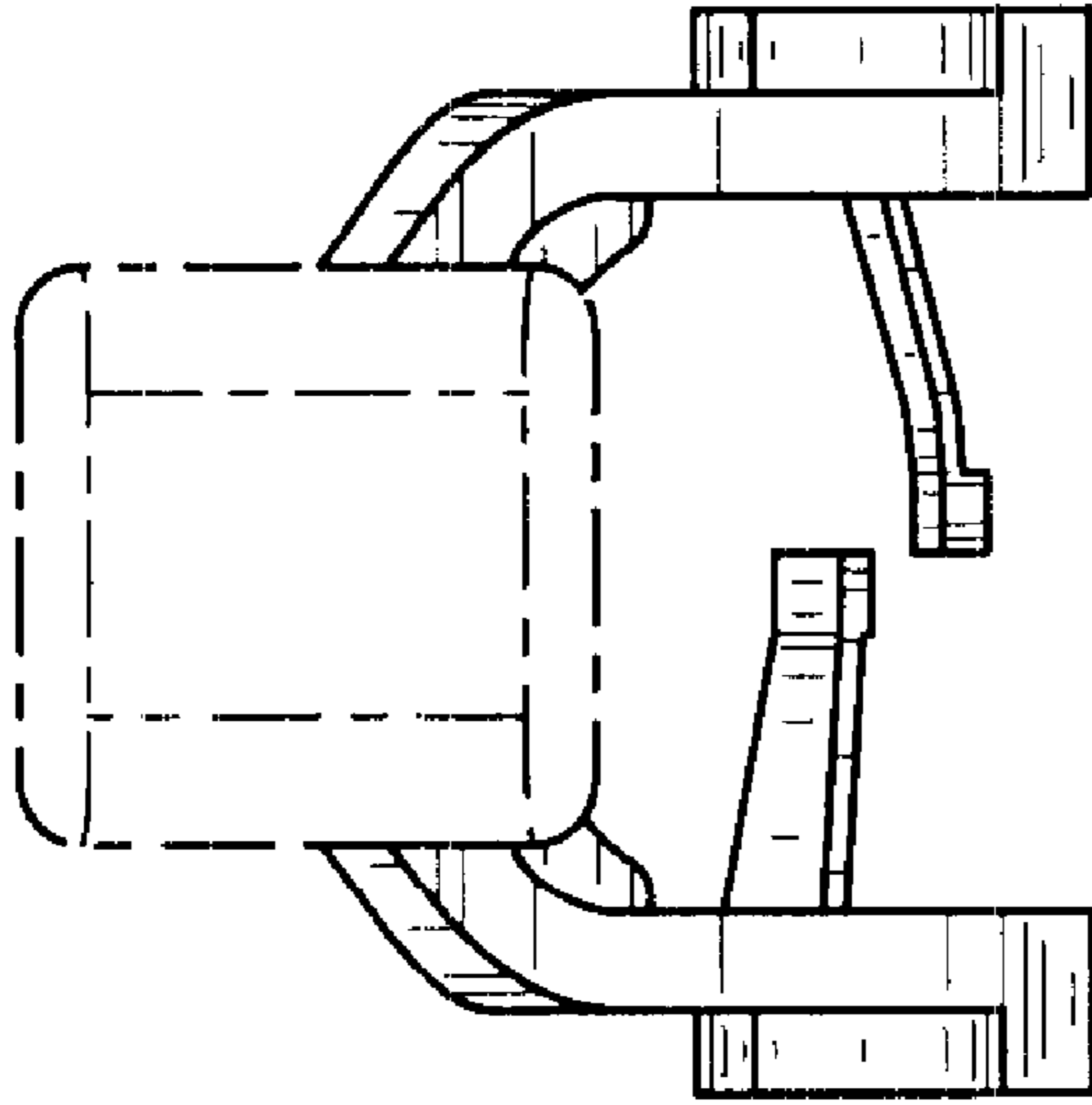

FIG. 5

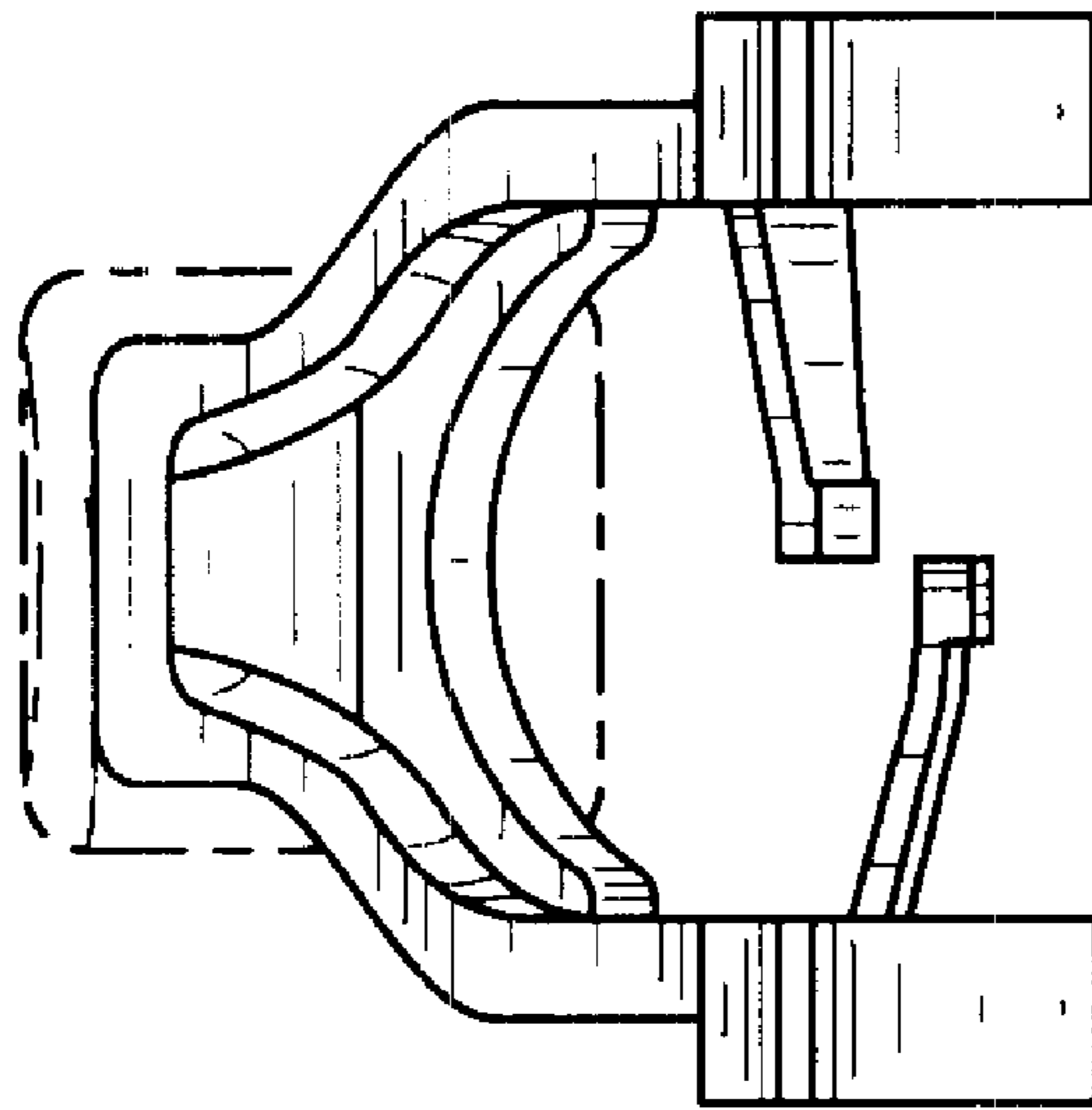

FIG. 6