



US00D467364S

(12) **United States Design Patent**
Yang

(10) **Patent No.:** **US D467,364 S**

(45) **Date of Patent:** **** Dec. 17, 2002**

(54) **TAIL LIGHT**

D450,142 S * 11/2001 Horowitz D26/28
D457,258 S * 5/2002 Horowitz D26/28

(75) Inventor: **Wen-Hsiung Yang**, Tainan Hsien (TW)

* cited by examiner

(73) Assignee: **TYC Brother Industrial Co., Ltd.**
(TW)

Primary Examiner—Marcus A. Jackson
(74) *Attorney, Agent, or Firm*—Ostrolenk, Faber, Gerb & Soffen, LLP

(**) Term: **14 Years**

(57) **CLAIM**

(21) Appl. No.: **29/155,178**

The ornamental design for tail light, as shown and described.

(22) Filed: **Feb. 5, 2002**

DESCRIPTION

(51) **LOC (7) Cl.** **26-06**

(52) **U.S. Cl.** **D26/28**

(58) **Field of Search** D26/28-36, 120,
D26/122; 362/61, 80, 81, 82, 83, 83.4,
267, 269, 275

FIG. 1 is a perspective view of tail light showing my new design;

FIG. 2 is a front elevational view thereof;

FIG. 3 is a rear elevational view thereof;

FIG. 4 is left side elevational view thereof;

FIG. 5 is a right side elevational view thereof;

FIG. 6 is a top plan view thereof; and,

FIG. 7 is a bottom plan view thereof.

(56) **References Cited**

U.S. PATENT DOCUMENTS

D448,869 S * 10/2001 Horowitz D26/28

1 Claim, 4 Drawing Sheets

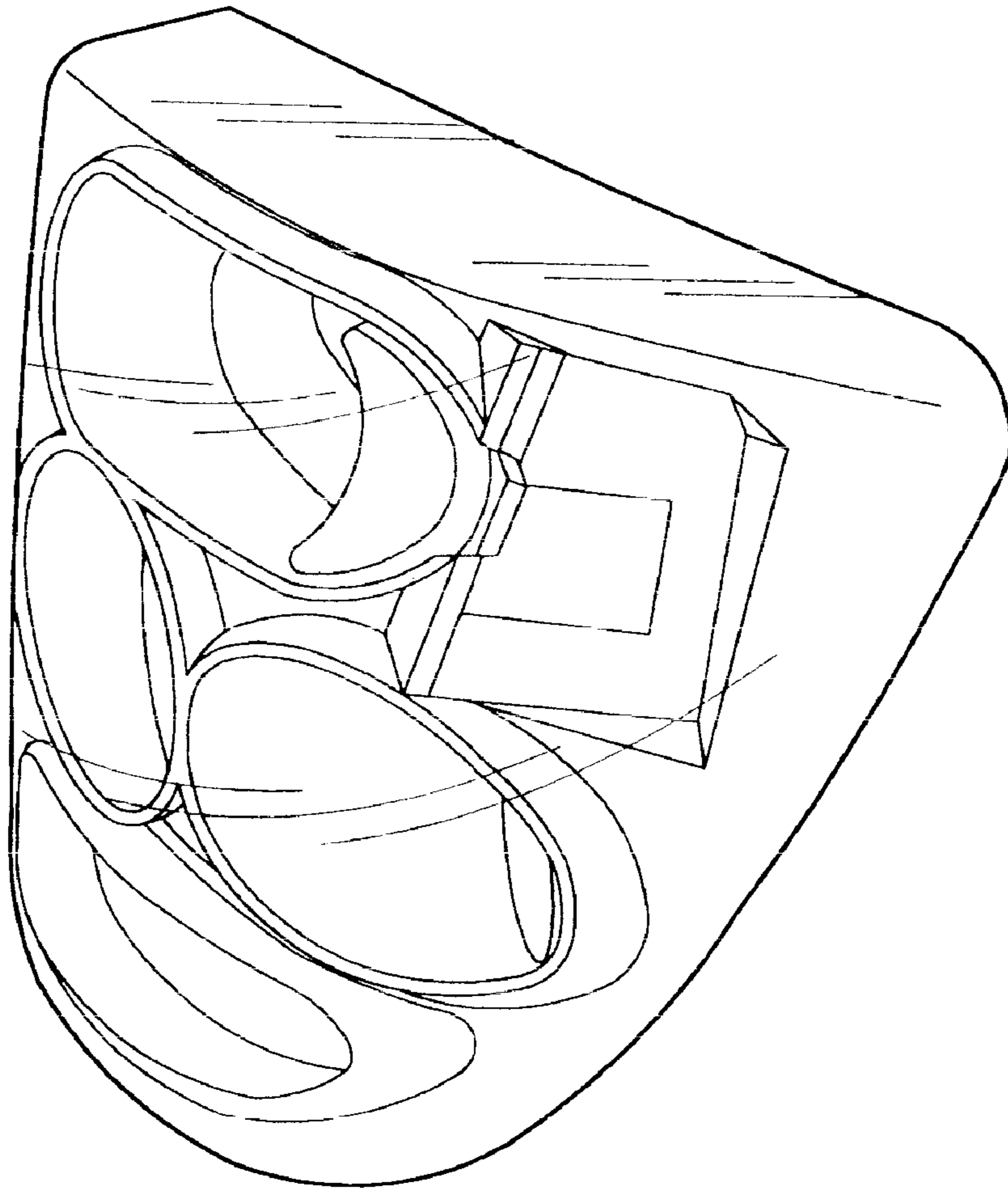

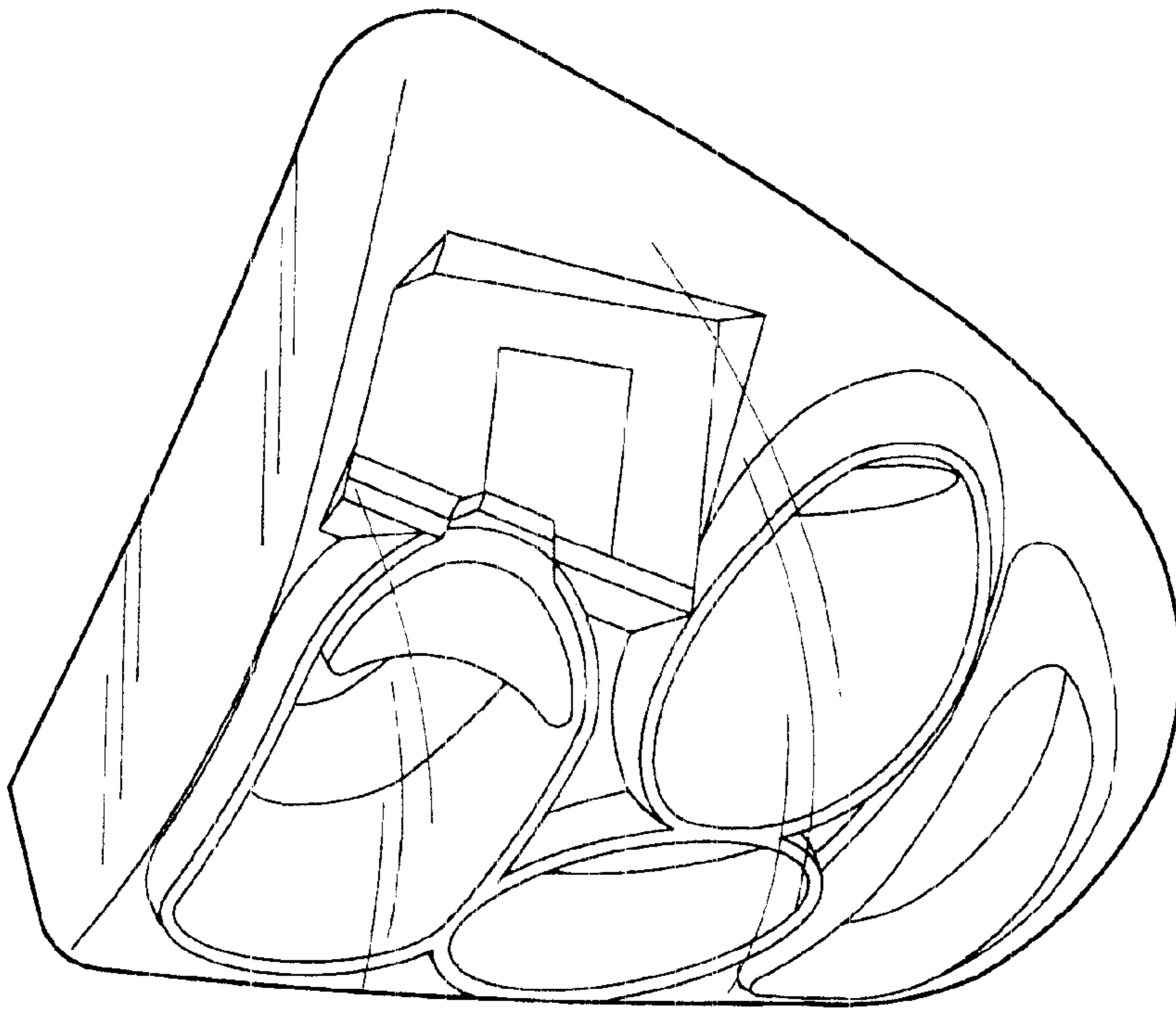

FIG. 1

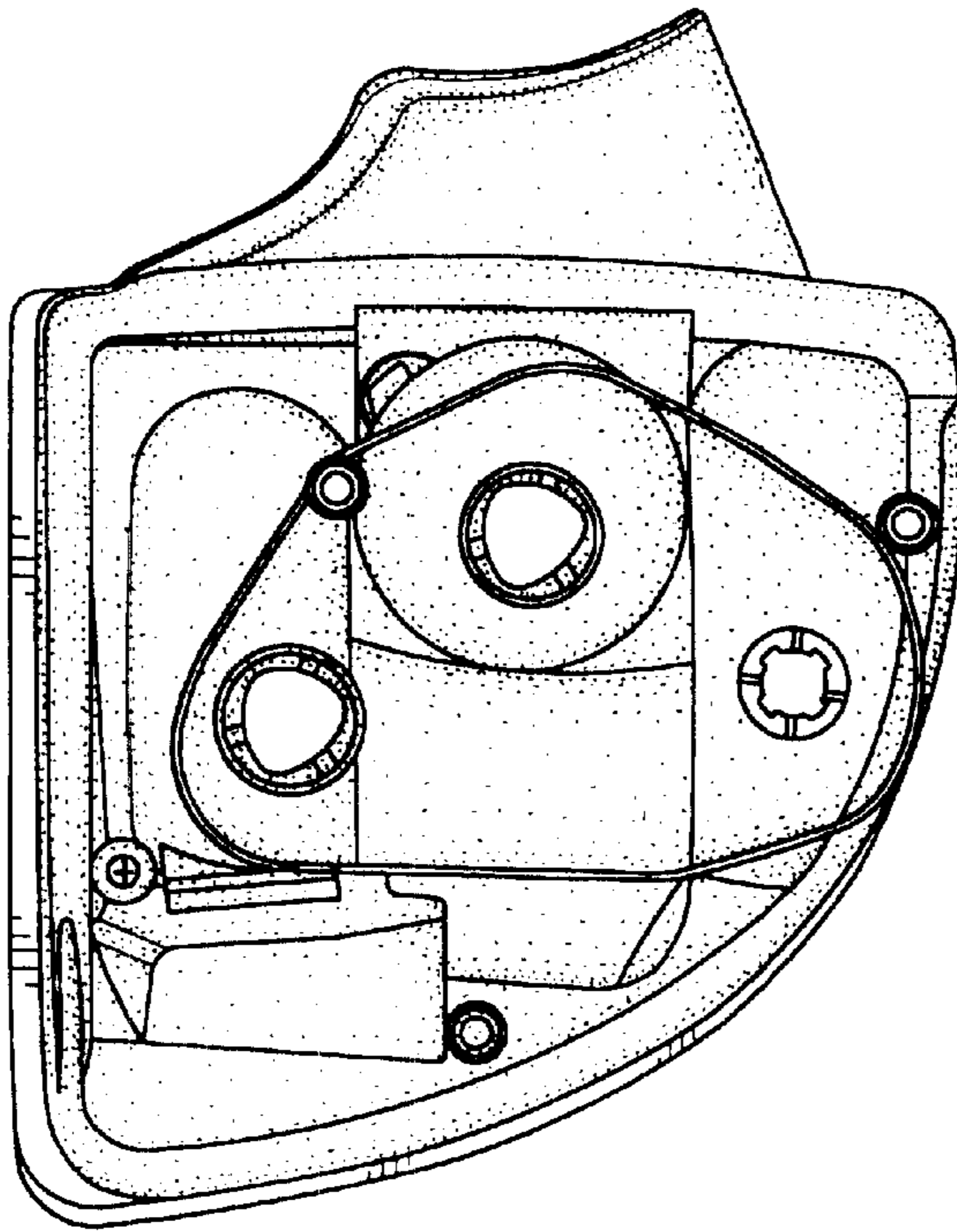

FIG. 3

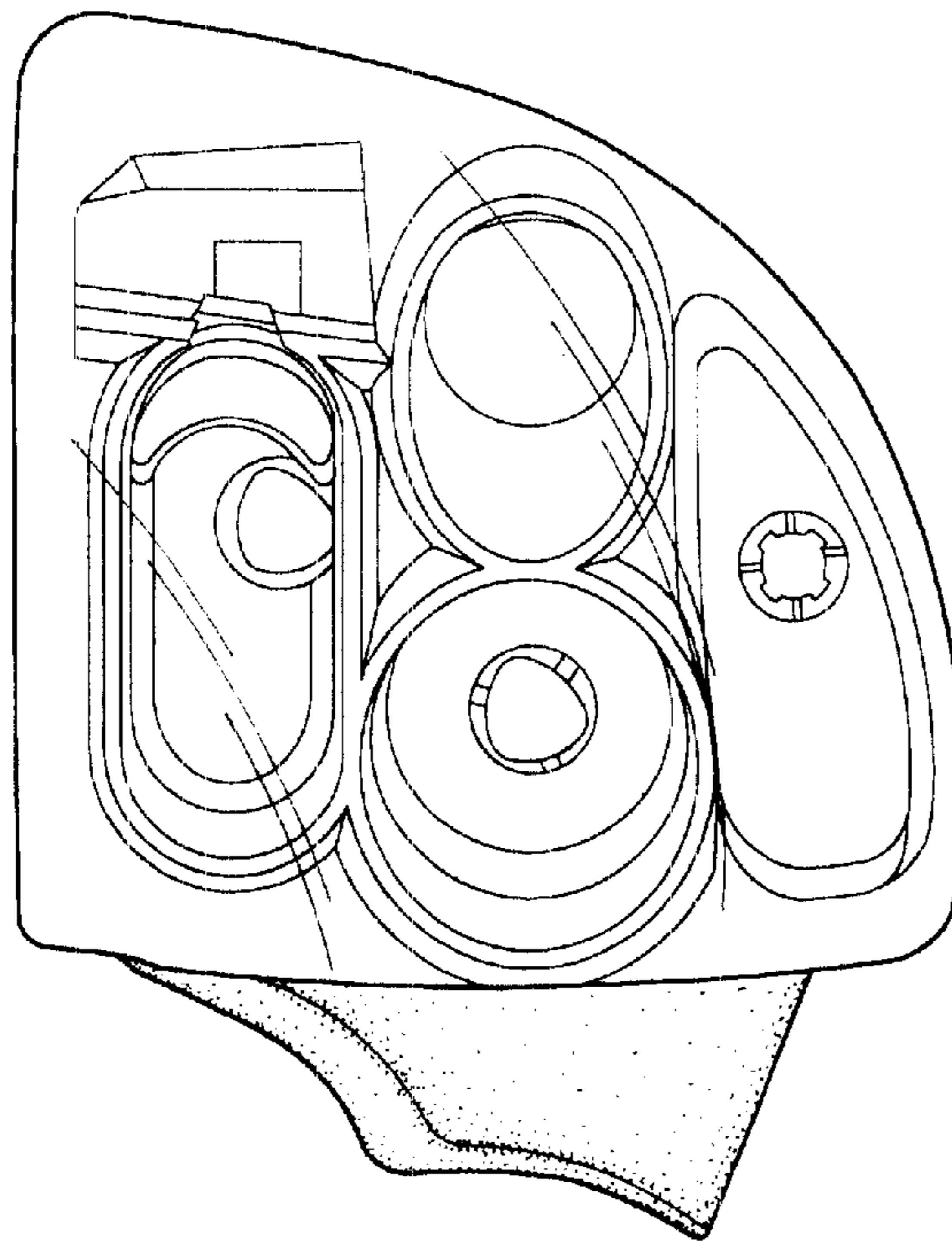

FIG. 2

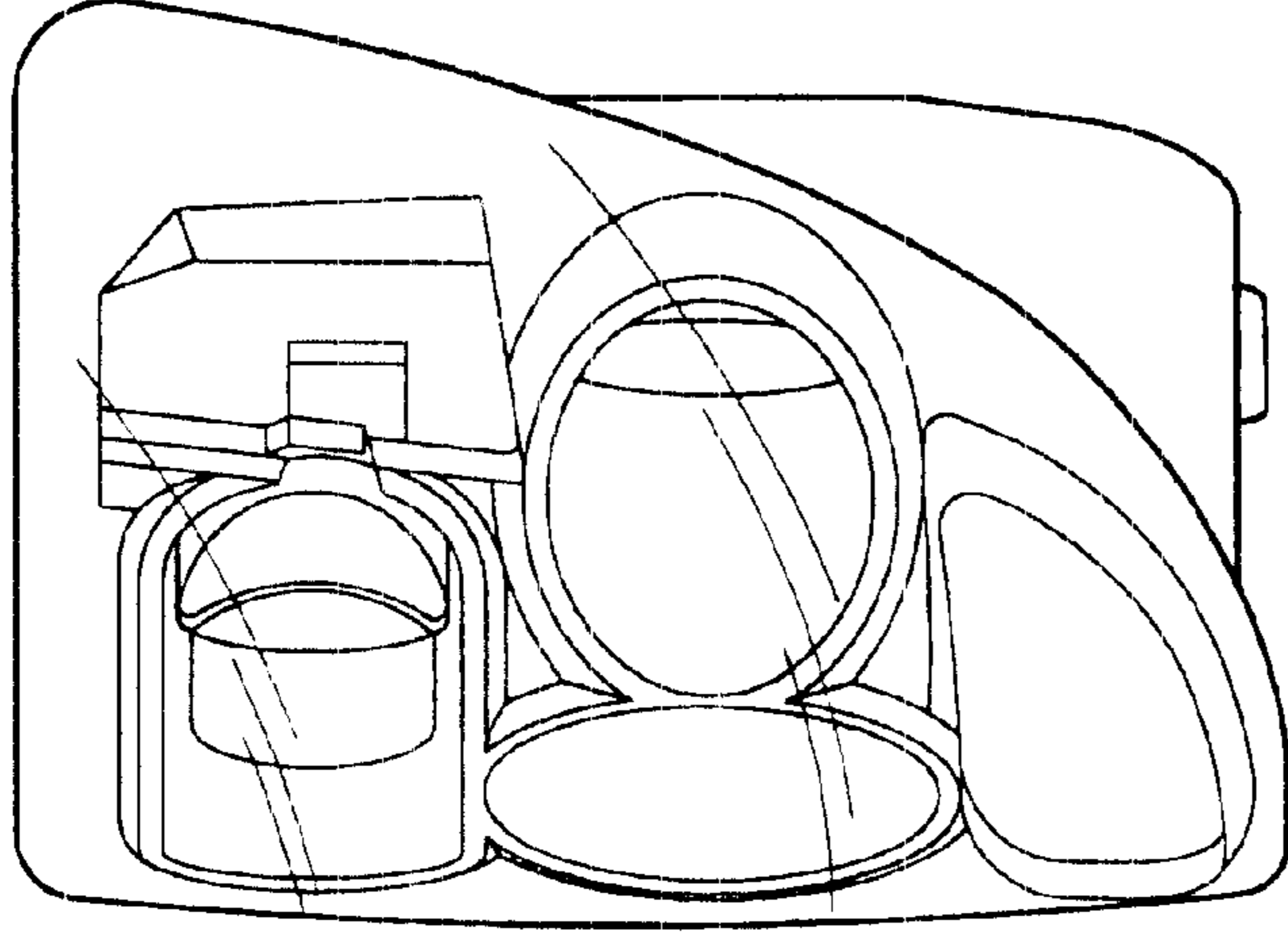

FIG. 5

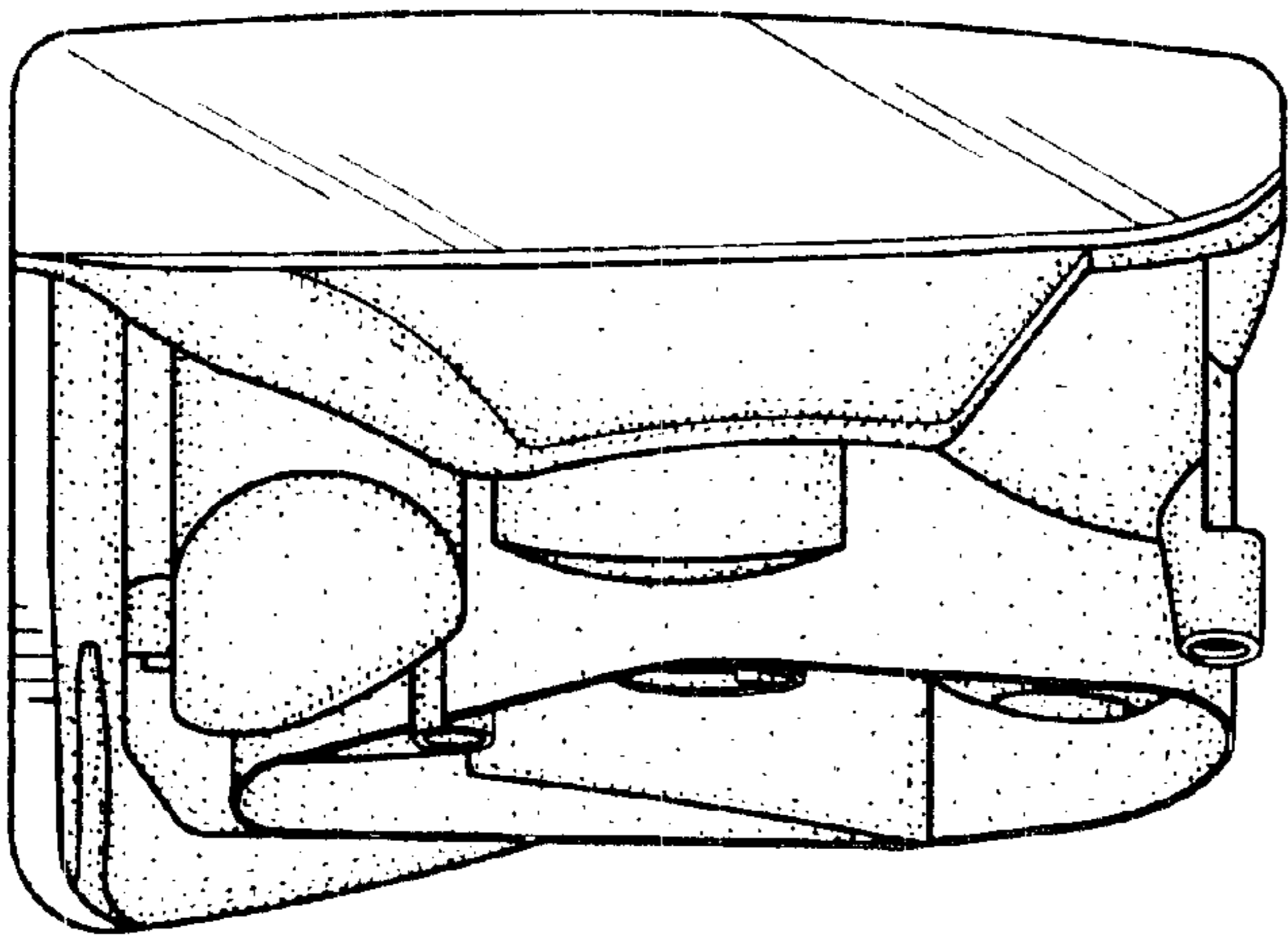

FIG. 4

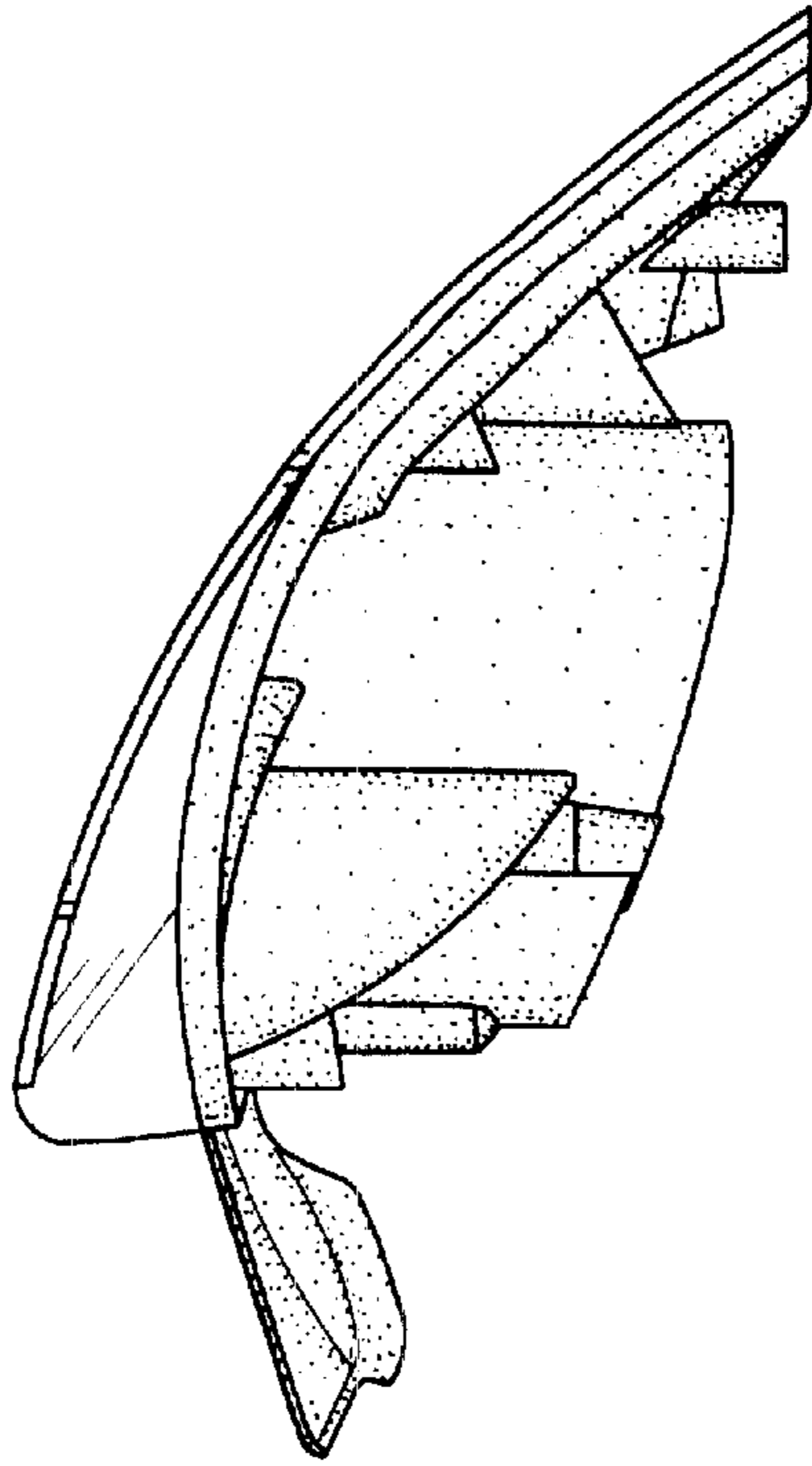

FIG. 6

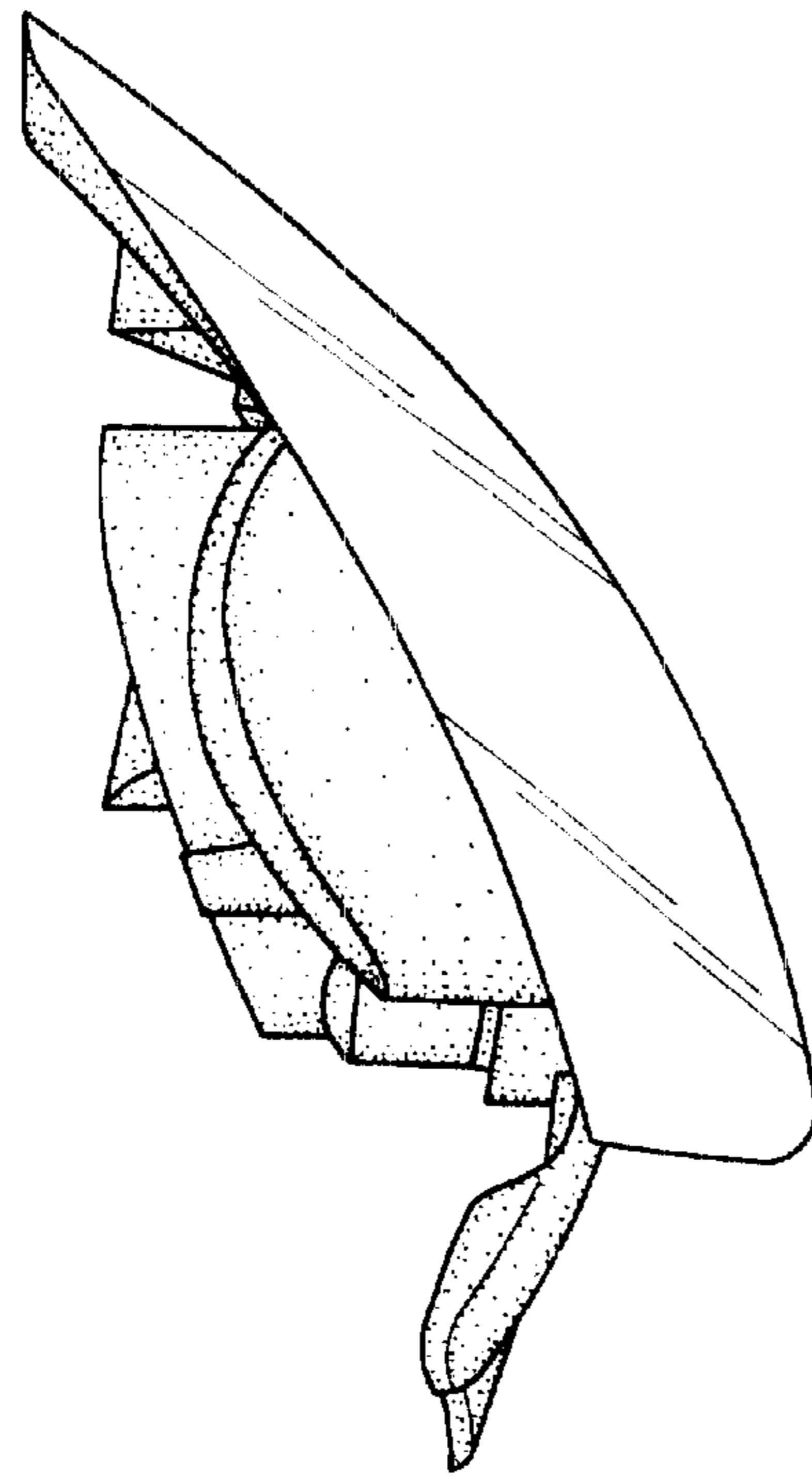

FIG. 7